































CONTENTS

	TRACTOR & PERKINS.....	01-18
	JOHN DEERE.....	19
	DEUTZ	20-22
	BEOGRAD IMT	22-23
	J.C.B	23-25
	KUBOTA.....	25-26
	CUMMINS	26-27
	FIAT &IVECO CNH.....	27-34
	FORD	34-37
	OPEL.....	37-38
	NISSAN	39-40
	MITSUBISHI	41-42
	ISUZU.....	42
	RUSSIAN CAR	43-45
	LAND ROVER	45-46
	PAYKAN	46
	RENAULT.....	47-52
	PEUGEOT	52-54
	VOLKSWAGEN	54-56
	KIA	56
	AMERICAN CAR	56-60
	TOYOTA.....	61-65
	DAIHATSU.....	65-66
	MAZDA.....	66-68
	BENZ.....	68
	SUZUKI.....	68-69
	HONDA.....	70
	OIL-WATER SEPARATOR	71-77
	ELECTRONIC FUEL PUMP.....	78-81

FUEL PUMP

TRACTOR&PERKINS SERIES

TR-1001		IN G 1/2"-20 UNF OUT 1/2"-20 UNF	REFERENCE NO. OEM NUMBER		CAR & MODEL	ENG.	YEAR	TYPE & REMARKS
			BCD 1693/1 DW606 05058066 2641465 461-161 7950732 7950948	7971025 994091 AK-044/1 FP161	ALLIS-CHALMERS (USA) BARBER-GREEN	Perkins Perkins Perkins	-4.236TA -4.236TA	Tr.Harvester Sa40

TR-1002		IN G 1/2"-20 UNF OUT 1/2"-20 UNF	REFERENCE NO. OEM NUMBER		CAR & MODEL	ENG.	YEAR	TYPE & REMARKS
			BCD 2697 2641A057 2641A067 2641A082 AK-183 U5LPK005 ULPK0034 4224451M91	4222106M91 FP664	MASSEY FERGUSON PERKINS	MF 6130 Industrial	Perkins 1004 4.40 Perkins 1004 4.40	

TR-1003		IN G 1/2"-20 UNF OUT 1/2"-20 UNF	REFERENCE NO. OEM NUMBER		CAR & MODEL	ENG.	YEAR	TYPE & REMARKS
			BCD 1873/1 DW647 2641711 2641A053 2641A073 3634250 461-259 7990178	AK-064 AK-061/0 AK-064/1 4757883 ULPK0003	LANDIN 4HOLES	Perkins 4.236 Perkins A4.236 Perkins 4.236 Perkins 4.238	Tr:6400,6500MKII 4RM Tr:6830 Tr:7500,7500 4RM Tr:8500,8500 4RM	

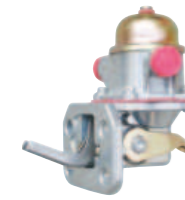
TR-1004		IN M12x1.5 OUT M12x1.5	REFERENCE NO. OEM NUMBER		CAR & MODEL	ENG.	YEAR	TYPE & REMARKS
			BCD 1873/1 2641725 2641711 2641A053 2741711 3637300M91 1447688M91 144707M91	AK-063/1 FP1152	LANDIN 4HOLES	Perkins 4.236 Perkins A4.236 Perkins 4.236 Perkins 4.238 Perkins 4.238	Tr:6400,6500MKII 4RM Tr:6830 Tr:7500,7500 4RM Tr:8500,8500 4RM	

TR-1005		IN G 1/2"-20 UNF OUT 1/2"-20 UNF	REFERENCE NO. OEM NUMBER		CAR & MODEL	ENG.	YEAR	TYPE & REMARKS
			BCD 1942/1 25061593 25066397 2641719 2641720 2641729 2641A070 461-310 60251 907073	93151005 AK-150 Fp310 PL-1009 ULPK0002 MF-399	BEDFORD HYSTER J.C.B. LANCER BOSS LANDINI LAVERDA LEYLAND-ROVER MASSEY FERGUSON PERKINS	Perkins 6.354.4 Perkins 6.354.4 Perkins 6.354.4 Perkins 6.354.4 Perkins 6.354.4 Perkins 6.354.4 Perkins 6.354.4 Perkins 6.354.4	Tr:10500,12500,13500 Tr:14500,145004RM Tr:MF1100,113414500 Tr:MF1250,2720,530 Tr:MF2620,2640,2680 Tr:MF2620,2680 Beuvis Tr:MF185 33C,530 Tr:Ag:4RM Industrial Dodge 100 Shovel Loader	

TR-1006		IN G 1/2"-20 UNF OUT 1/2"-20 UNF	REFERENCE NO. OEM NUMBER		CAR & MODEL	ENG.	YEAR	TYPE & REMARKS
			BCD 1987 25061608 25066379 2641704 2641712 2641808 461-312 93151069 994183	994295 AK-083 AK-083/1 FP312 ULPK0004	JOHNSTON BROS LANDINI LEYLAND-ROVER LINDNER MASSEY FERGUSON PERKINS	Perkins D3.152 Perkins D3.152 Perkins D3.152 Perkins D3.152 Perkins D3.152 Perkins D3.152	Ford Truck S30/40C FLT Tr.MF244 Tr.Ind.MF2203-7,2205-7 Tr.MF133,135 Tr.MF135,135/2135 Tr.MF148 Tr.MF235,245,255 Tr.MF550 Industriale	

TR-1007		IN G 1/2"-20 UNF OUT 1/2"-20 UNF	REFERENCE NO. OEM NUMBER		CAR & MODEL	ENG.	YEAR	TYPE & REMARKS
			BCD 1902/5 25061552 351-12151 352-83780 461-240 572-71982 7990046 FP240 SP105		LISTER PETTER	SERIE SR		

FUEL PUMP

TRACTOR&PERKINS SERIES

TR-1008		IN G 1/2"-20 UNF OUT 1/2"-20 UNF	REFERENCE NO. OEM NUMBER		CAR & MODEL	ENG.	YEAR	TYPE & REMARKS
			BCD 1873/1 DW647 2641711 2641A053 2641A073 3634250 461-259 7990178	AK-064 AK-061/0 AK-064/1 4757883 ULPK0003	LANDIN 4HOLES	Perkins 4.236 Perkins A4.236 Perkins 4.236 Perkins 4.238 Perkins 4.238	Tr:6400,6500MKII 4RM Tr:6830 Tr:7500,75004RM Tr:8500,8500 4RM	

TR-1009		IN G 1/2"-20 UNF OUT 1/2"-20 UNF	REFERENCE NO. OEM NUMBER		CAR & MODEL	ENG.	YEAR	TYPE & REMARKS
			BCD 1535/2 25061494 25066393 461-170 461-171 7950300 7950773 7971072 7971073 808137	808313 FP170 PON 115	LEYLAND-ROVER UNFIELD	4/98D,NT 5.1&5.7Lit.V.Diesel 6/98Diesel 4/65 3,ST.TA,TD 6/98 DT,NT 3,8Lit.Diesel 5,1Lit.V.Diesel 5,7Lit.V.Diesel 5.1&5.7Lit.V.Diesel	1972 1973 1974 1970 1970-1972 1971-1972 1973-8/83 1971-1973 1965-1970 1968	

TR-1010		IN G 1/2"-20 UNF OUT 1/2"-20 UNF	REFERENCE NO. OEM NUMBER		CAR & MODEL	ENG.	YEAR	TYPE & REMARKS
			BCD1549/1 DW614 25061518 25066392 461-159 7950500 7971020 816038 91145758 A4021132 A4021133	AO-045 FP159 PON113	BEDFORD	Diesel 330	1970...	C Truck,Mtruck P Autotelaio 300 &330 R Truck TJ Truck CO Series 300 TJ Truck CO Series 330 TK Truck EOM, N,Q,T,V,HRX3 TL VAAutotelaio

TR-1011		IN G 1/2"-20 UNF OUT 1/2"-20 UNF	REFERENCE NO. OEM NUMBER		CAR & MODEL	ENG.	YEAR	TYPE & REMARKS
			BCD 2566 2641A052 93151664 SP066 ULPK0005 4222106M91 F055477 17913600 3639696M91	PE2641A067 PEULPK0005 U5LPK005 549553	MASSEY FERGUSON MASSEY FERGUSON MASSEY FERGUSON MASSEY FERGUSON MASSEY FERGUSON MASSEY FERGUSON PERKINS	PERKINS 1000 SERIES		

TR-1012		IN G 1/2"-20 UNF OUT 1/2"-20 UNF	REFERENCE NO. OEM NUMBER		CAR & MODEL	ENG.	YEAR	TYPE & REMARKS
			BCD 1873/5 DW647 2641711 264A053 2641A073 3637250 461-259 7990178 AK-064	AK-064/0 AK-064/1	LANDINI	Perkins 4.236 Perkins A4.236 Perkins 4.236 Perkins 4.238	Tr:6400,6500MKII 4RM Tr:6830 Tr:7500,7500 4RM Tr:8500,8500 4RM	

TR-1013		IN M10x1 OUT M10x1	REFERENCE NO. OEM NUMBER		CAR & MODEL	ENG.	YEAR	TYPE & REMARKS
			BCD 1929/5 5.006.585.032 6416.6585.27 7984414 9.06.078.11 AS-050/4 POC 106		LOMARDINI LOMARDINI INDUSTRIAL INDUSTRIAL	500,520,530,(GR.1)DIESEL 6LD 260(GR.6) DIESEL		

TR-1014		IN G 1/2"-20 UNF OUT 1/2"-20 UNF	REFERENCE NO. OEM NUMBER		CAR & MODEL	ENG.	YEAR	TYPE & REMARKS
			BCD 1873/1 2641725 2641711 2641A053 2741711 3637300M91 1447688M91	144707M91 AK-063/1 FP1152	LANDINI 4HOLES	Perkins 4.236 Perkins A4.236 Perkins 4.236 Perkins 4.238 Perkins 4.238	Tr:6400,6500MKII 4RM Tr:6830 Tr:7500,7500 4RM Tr:8500,8500 4RM	

FUEL PUMP

TRACTOR&PERKINS SERIES

TR-1015	IN G 1/2"-20 UNF OUT1/2"-20 UNF	REFERENCE NO. OEM NUMBER	CAR & MODEL	ENG.	YEAR	TYPE & REMARKS
		BCD 1987 DW648 25061608 2641704 26411808 93151069 994183 AK-083	AK-083/1 FP312	JOHNSTON BROS LANDINI	PerkinsD3.152 PerkinsD3.152	Ford Truck S30/40C FLT Tr.MF244 Tr.Ind.MF2203-7,2205-7 Tr.MF133,135 Tr.MF135,135/2135 Tr.MF148 Tr.MF235,245,255 Tr.MF550 Industriale

TR-1016	IN G 1/2"-20 UNF OUT1/2"-20 UNF	REFERENCE NO. OEM NUMBER	CAR & MODEL	ENG.	YEAR	TYPE & REMARKS
		BCD 1535/2 25061494 25066393 461-170 461-171 7950300 7950773 7971072 7971073 808137	808313 FP170 PON 115	BEDFORD	4/98D,NT 5.1&5,7Lit.V.Diesel 6/98Diesel 4/65 3.ST.TA,TD 6/98 DT,NT 3,8Lit.Diesel 5.1Lit.V.Diesel 5.7Lit.V.Diesel 5.1&5,7Lit.V.Diesel 1972 1973 1974 1970 1970-1972 1971-1972 1973-8/83 1971-1973 1965-1970 1968	

TR-1017	IN G 1/2"-20 UNF OUT1/2"-20 UNF	REFERENCE NO. OEM NUMBER	CAR & MODEL	ENG.	YEAR	TYPE & REMARKS
		BCD 1877/1 25061525 25066394 281756 461-176 62H557 7971139	807787 FP176 IC-005 DW622	J4 VAN DTESED BUCHER(CH) TR2200K,TR2502500K LEYLAND 1.5LIT.DTESEL LEYLAND-BLUELINE TRUCKS SHERPA DTESEL BRITISH LEYLAND COMMERCIAL JU DIESEL J2 VAN DIESEL	1966... 1966... 1968-1974 1967-1978	

TR-1018	IN M14x1.5 OUT M14x1.5	REFERENCE NO. OEM NUMBER	CAR & MODEL	ENG.	YEAR	TYPE & REMARKS
		BCD1832/1 2641344 461-136 7950624 7950769 AK-041	Massey Ferguson Perkins 6AT.354,6A,354 Perkins 6A.354,6AT,354 Perkins 6AT.354,6A,354 Perkins 4A.300 Perkins.4A300,6A354,6AT354	- -	MF 1100,1130 MF 44 MF 4488,5400 TR.400,TX37 SUPER 90 Motore industriale (diversi)	

TR-1019	IN G 1/2"-20 UNF OUT1/2"-20 UNF	REFERENCE NO. OEM NUMBER	CAR & MODEL	ENG.	YEAR	TYPE & REMARKS
		BCD 1942/1 25061593 25066397 2641719 2641720 2641729 2641A070 461-310 60251 907073	93151005 AK-150 FP310 PL-1009 ULPK0002 MF-399	BEDFORD HYSTER J.C.B. LANCER BOSS LANDINI LAVERDA LEYLAND-ROVER MASSEY FERGUSON PERKINS	Perkins 6.354.4 Perkins 6.354.4 Perkins 6.354.4 Perkins 6.354.4 Perkins 6.354.4 Perkins 6.354.4 Perkins 6.354.4 Perkins 6.354.4 Perkins 6.354.4	Tr.10500,12500,13500 Tr.14500,145004RM Tr.MF1100,113414500 Tr.MF1250,2720,530 Tr.MF2620,2640,2680 Tr.MF2620,2680 Beuvals Tr.MFX185 33C,530 Tr.Agr.4RM Industrial Dodge 100 Shovel Loader

TR-1020	IN G 1/2"-20 UNF OUT1/2"-20 UNF	REFERENCE NO. OEM NUMBER	CAR & MODEL	ENG.	YEAR	TYPE & REMARKS
		BCD 1873/1 DW647 2641711 2641A053 2641A073 3634250 461-259 7990178	AK-064 AK-061/0 AK-064/1 4757883 ULPK0003	LANDINI 4HOLES	Perkins 4.236 Perkins A4.236 Perkins 4.236 Perkins 4.238	Tr.6400,6500MKII 4RM Tr.6830 Tr.7500,7500 4RM Tr.8500,8500 4RM

TR-1021	IN G 1/2"-20 UNF OUT1/2"-20 UNF	REFERENCE NO. OEM NUMBER	CAR & MODEL	ENG.	YEAR	TYPE & REMARKS
		BCD 2567 25061557 25061567 26411709 26411713 2641725 1641A055 2641A066 461-251 461-264	7990114 7990268 910602 994141 AK-063 AK-063/0 FP251 FP264 PL-1005 PL-1008	ULPK0001 ULPK0022	ACTIV FISCHER BRISTOL CARRARO LANDINI MASSEY FERGUSON PERKINS TALBOT TOWMOTOR	Perkins 4.236 Perkins 4.238 Perkins 4.212 Perkins 4.248 1974... 1967... 1974... 1967... Tr.MF168,175 Tr.MF178,185 Tr.MF285,290 Tr.MF565,575 Tractor P300 Tractor P827 T500,P838 Tractor F82,F83 G65,G80,F407

FUEL PUMP

TRACTOR&PERKINS SERIES

TR-1022	IN G 1/2"-20 UNF OUT1/2"-20 UNF	REFERENCE NO. OEM NUMBER	CAR & MODEL	ENG.	YEAR	TYPE & REMARKS
		BCD 2697 2641A057 2641A067 2641A082 AK-183 U5LPK005 ULPK0005 ULPK0034	MASSEY FERGUSON PERKINS	Perkins 1004 4.40 1004 4.40		MF 6130 Industriale

TR-1023	IN G 1/2"-20 UNF OUT1/2"-20 UNF	REFERENCE NO. OEM NUMBER	CAR & MODEL	ENG.	YEAR	TYPE & REMARKS
		BCD 1812 25601529 25066378 2641309 2641310 2641311 2641A063 3960 461-167 461-184	7971040 7971233 994094 AK-008 AK-008/1 AK-078 FP184 PL 3960 ULPK0006	EICHER LANDINI LEYLAND-ROVER LINDNER MASSEY FERGUSON PERKINS	PerkinsD3.152 Perkins3.152 PerkinsD3.152 Perkins3AD.152 PerkinsD3.152 Perkins3AD.152	Tr.3155,3255,3256 Tr.4500,5500,4RM Tr.245,253 Tr.Transporter 520S Tr.MF135,140 Tr.MF148,152 Tr.MF235,245 Tr.MF254,255

TR-1026	IN G 1/2"-20 UNF OUT1/2"-20 UNF	REFERENCE NO. OEM NUMBER	CAR & MODEL	ENG.	YEAR	TYPE & REMARKS
		BCD 1873/1 DW647 2641711 2641A053 2641A073 3634250 461-259 7990178	AK-064 AK-061/0 AK-064/1 4757883 ULPK0003	LANDINI 4HOLES	Perkins 4.236 Perkins A4.236 Perkins 4.236 Perkins 4.238	Tr.6400,6500MKII 4RM Tr.6830 Tr.7500,7500 4RM Tr.8500,8500 4RM

TR-1027	IN M14x1.5 OUT M14x1.5	REFERENCE NO. OEM NUMBER	CAR & MODEL	ENG.	YEAR	TYPE & REMARKS
		BCD 1687/1 05042263 25061495 2506151D 25066409 2641372/4/5/7 2641A064 34167 3679325 461-131/2/3/5	5043611 6637508 676319 78113 7950598/730/764/765/766/768 AK-096 FP132/133 PON 112 ULPK0007	J.C.B. LANDINI LEYLAND-ROVER MASSEY FERGUSON PERKINS TALBOT	Perkins 6.354 1965... 11/1973... 1965-1970 1966... 1965-1970 1972... 1965-1978	Tr.MF507,520,525 Tr.MF 1104,R9500 Truck R141,R142 R149,M169 Dodge D406,D500

TR-1028	IN M12x1.5 OUT M12x1.5	REFERENCE NO. OEM NUMBER	CAR & MODEL	ENG.	YEAR	TYPE & REMARKS
		BCD 1687/2 25061506 25061511 25061566 25066405 2641371 461-116 461-137 461-263 60252	781114 78997 78-1114 78-1114 7950499 7950770 7990265 79-1113 AK-110 FP137 PL-1006	AEC ALLIS-CHALMERS(USA) BRISTOL LEYLAND-ROVER PERKINS SISU(VALTRA) TALBOT	...1966 1963... 1958-1965 1965... 1965-1970	AV 275,312,319,470 AV 470E,590 AV505 AV 690/5B Industriale Reliance Express Coach Tr.BTL 12D,14D,16D,20D Titan 680,690 Contractor AV760

TR-1029	IN M12x1.5 OUT M12x1.5	REFERENCE NO. OEM NUMBER	CAR & MODEL	ENG.	YEAR	TYPE & REMARKS
		BCD1752/1 DW653 25061524 25066404 2641328 461-175 AK-104 FP175	LANDINI MASSEY FERGUSON	Perkins 4.203 Perkins 4AD.203 Perkins 4AD.203,4AD.203.1	1966	Tr.6500 Tr.165,300,HX21 Tr.DX45,HX211,MF165 Tr.MF 153,158ET,158MK III Tr.MF 300,302,304 Tr.MF 304,365,3165S Tr.MF 3303,3305 Tr.MF 560 Tr.MF 756

TR-1030	IN M12x1.5 OUT M12x1.5	REFERENCE NO. OEM NUMBER	CAR & MODEL	ENG.	YEAR	TYPE & REMARKS
		BCD1009/5 2195044 2226886 2266327 9.06.037.11 POC 042	LANCIA LANCIA LANCIA PALMIERI	1100. 1300,1600,2000 PDA 625,1250		Fiavia Super Jolly Fulvia 2C,GT,HF Fulvia Coupe,Rally Industriale

FUEL PUMP

TRACTOR&PERKINS SERIES

TR-1031	IN G 1/2"-20 UNF OUT 1/2"-20 UNF	REFERENCE NO. OEM NUMBER	CAR & MODEL	ENG.	YEAR	TYPE & REMARKS
		BCD 1881 461-267 7950899 SP034 B909444 K311939 K909944 FP267	DAVID BROWN 990,1200	4 CYI DIESEL		

TR-1032	IN G 1/2"-20 UNF OUT 1/2"-20 UNF	REFERENCE NO. OEM NUMBER	CAR & MODEL	ENG.	YEAR	TYPE & REMARKS
		BCD 1873/1 DW647 2641711 2641A053 2641A073 3634250 461-259 7990178	LANDINI 4HOLES	Perkins 4.236 Perkins A4.236 Perkins 4.236 Perkins 4.238		Tr.6400,6500MKII 4RM Tr.6830 Tr.7500,7500 4RM Tr.8500,8500 4RM

TR-1033	IN G 1/2"-20 UNF OUT 1/2"-20 UNF	REFERENCE NO. OEM NUMBER	CAR & MODEL	ENG.	YEAR	TYPE & REMARKS
		BCD 1987 25061608 25066379 2641704 2641712 2641808 461-302 93151069 994183	JOHNSTON BROS LANDINI LEYLAND-ROVER LINDNER MASSEY FERGUSON PERKINS	PerkinsD3.152 PerkinsD3.152 PerkinsD3.152 PerkinsD3.152 PerkinsD3.152 PerkinsD3.152		Ford Truck S30/40C FLT Tr.MF244 Tr.Ind.MF2203-7,2205-7 Tr.MF133,135 Tr.MF135,135/2135 Tr.MF148 Tr.MF235,245,255 Tr.MF550 Industriale

TR-1034	IN 1/2"-20 UNF OUT 1/2"-20 UNF	REFERENCE NO. OEM NUMBER	CAR & MODEL	ENG.	YEAR	TYPE & REMARKS
		BCD 2674 757-14171 757-14173 757-14174 757-14175	Lister Petter Motore Serie Alpha Motore Serie Alpha Motore Serie Alpha Motore Serie Alpha	Lister Petter LPA2,LPA3 Lister Petter LPW2,LPW3,LPW4 Lister Petter LPWS2,LPWS3,LPWS4 Lister Petter LPWT4		

TR-1035	IN G 1/2"-20 UNF OUT 1/2"-20 UNF	REFERENCE NO. OEM NUMBER	CAR & MODEL	ENG.	YEAR	TYPE & REMARKS
		BCD 1529/1 25061512 25066407 2641345 2641A065 3490336 4309795 461-138 5042232	LANDINI LANSING BAGNALL MASSEY FERGUSON MOTOR IBERICA ORENSTEIN E KOPPEL PERKINS PANSOMES & RAPIER RUBERY OWEN TALBOT	Perkins 4.203 Perkins D4.203 Perkins 4A/192 4A/230 Perkins 3.152.1 Perkins 3A.144 3A.144,3.152.1 3.152TA A3.152.D3.152	1965... 1963... 1967 1963 1965... 1967... 1965...	Tr.MF 65.MK III Tr.MF 65,165,285 1080,1085 Tr.Mod.165 Ford Truck S60B H60C Tr.6000

TR-1036	IN G 1/2"-20 UNF OUT 1/2"-20 UNF	REFERENCE NO. OEM NUMBER	CAR & MODEL	ENG.	YEAR	TYPE & REMARKS
		BCD 1695/1 25061520 25066019 25066401 2641406 2641408 3729945 461-165 60250	CONSOUDATED PNEUMATIC FFNWICK HYSTER INGERSOLL LANDINI MARSHALL MASSEY FERGUSON PERKINS	Perkins 3.152.1 Perkins 3A.144 3A.144,3.152.1 3.152TA A3.152.D3.152	1965... 1960... 1960... 1960... 1960... 1960... 1960... 1960... 1960...	Ford Truck S30/40C Tr.MF244,4000,5000 Tr.12 Tr.135 Tr.135,203,205 Tr.MF 135MK III,135V Tr.MF135,135ET Industriale

TR-1037	FUEL TAP	REFERENCE NO. OEM NUMBER	CAR & MODEL	ENG.	YEAR	TYPE & REMARKS
			MF 135,148,240			INDIA MODEL

FUEL PUMP

TRACTOR&PERKINS SERIES

TR-1038-1	FUEL TAP	REFERENCE NO. OEM NUMBER	CAR & MODEL	ENG.	YEAR	TYPE & REMARKS
			MF 135,148,240			TURKEY MODEL

TR-1038-2	FUEL TAP	REFERENCE NO. OEM NUMBER	CAR & MODEL	ENG.	YEAR	TYPE & REMARKS
			MF 135,148,240			TURKEY MODEL

TR-1039	FUEL TAP	REFERENCE NO. OEM NUMBER	CAR & MODEL	ENG.	YEAR	TYPE & REMARKS

TR-1040	FUEL PUMP	REFERENCE NO. OEM NUMBER	CAR & MODEL	ENG.	YEAR	TYPE & REMARKS
		BCD 1823 25061516 25066016 461-149 7950901 B908819	CASE-NEW HOLLAND DAVID BROWN DAVID BROWN DAVID BROWN	David Brown 3 cil.Diesel	1965-1974 1965-1974 1965... 1965-1974	Tr.1190,1290 1390,1490,1690 Tr.1390,1490 Tr.770,780,880 Tr.885,885n,1190 1290

TR-1041	FUEL PUMP	REFERENCE NO. OEM NUMBER	CAR & MODEL	ENG.	YEAR	TYPE & REMARKS
		BCD 2601 994185 AK-085	MOTOR IBERICA	Perkins D3.152		Applic,dicerse

TR-1042	FUEL PUMP	REFERENCE NO. OEM NUMBER	CAR & MODEL	ENG.	YEAR	TYPE & REMARKS
		BCD 2698 2641A068 2641A075 AK-151 ULPK0015 4222449M91 SP126 AK 151 FP068	HYSTER JCB JCB JCB JCB PERKINS	H 165,H 280 FORKLIFT 435 LOADER 712 DUMPER FASTRAC(635)125 FASTRAC(635)125 INDUSTRIAL		1006T (6 cil.turbo)

TR-1043	FUEL PUMP	REFERENCE NO. OEM NUMBER	CAR & MODEL	ENG.	YEAR	TYPE & REMARKS
		2641911	BALKANCAR	D 2500-20TB FORKLIFT		

FUEL PUMP

TRACTOR&PERKINS SERIES

TR-1044		REFERENCE NO. OEM NUMBER		CAR & MODEL	ENG.	YEAR	TYPE & REMARKS
		BCD 1870/1	735145				
		25061514	7950885	ACTIV FISCHER	Perkins 4.154		Combine 800
		25066402	AK-100	ALSTHOM DIESELAIR	2,3,4,5,6 cil		Macchine Agricole
		2641326	PL-1004	BEDFORD	Perkins 4.154		CF Furgone
		2641327	ULPK0019	COLINDER MUNKTELL	4.154,4.203		Combine
		2641335		CLAAS	4.203		Compact 25 Combine
		461-147		DRONNINGBORG			Combine
		60249		PERKINS			Industriale
				PERKINS			Jeep Willis Pick-up

TR-1046		REFERENCE NO. OEM NUMBER		CAR & MODEL	ENG.	YEAR	TYPE & REMARKS
		4W0788	1052508				
				CATEPILLER			

TR-1047		REFERENCE NO. OEM NUMBER		CAR & MODEL	ENG.	YEAR	TYPE & REMARKS
		2641494					
				BALKANCAR	D 3900		20TB

TR-1048		REFERENCE NO. OEM NUMBER		CAR & MODEL	ENG.	YEAR	TYPE & REMARKS

TR -1049		REFERENCE NO. OEM NUMBER		CAR & MODEL	ENG.	YEAR	TYPE & REMARKS
		BCD 2710/1	354236A1,				
		83665391,	83665958,	VALTRA,			
		PD710,	83666344,	VALMET,			
		K9344,	BC344.	MASSEY FERGUSON,			
				CASE,			
				FORD 320DS-420DS-620DS			
				MOTORES SISU,			
				FLANGE 5 FUROS.			

TR-1050		REFERENCE NO. OEM NUMBER		CAR & MODEL	ENG.	YEAR	TYPE & REMARKS
		87802238					

TR-1051		REFERENCE NO. OEM NUMBER		CAR & MODEL	ENG.	YEAR	TYPE & REMARKS
		228-9129					

FUEL PUMP

TRACTOR&PERKINS SERIES

TR-1052		REFERENCE NO. OEM NUMBER		CAR & MODEL	ENG.	YEAR	TYPE & REMARKS
		ULPK0040,	4132A015M1,				
		4132A016M1					

TR-1053		REFERENCE NO. OEM NUMBER		CAR & MODEL	ENG.	YEAR	TYPE & REMARKS
		ULPK0041	3860191				

TR -1054		REFERENCE NO. OEM NUMBER		CAR & MODEL	ENG.	YEAR	TYPE & REMARKS
		1447072M91,	883786M91,				
		1876507M91,	193229M91,	Ford 2000,			Massey Ferguson 50,
		193239M91,	81811612,	Massey Ferguson,			Ford,
		TX10316,	TX10313,	Allis Chalmers,			International,
		3043645R91,	3597838M91	Landini,			Long,
				Oliver,			FIAT, White

TR -1055		REFERENCE NO. OEM NUMBER		CAR & MODEL	ENG.	YEAR	TYPE & REMARKS
		2656804	2656811				
		2656818 <td>5845B160 <td>MASSEY FERGUSON</td> <td></td> <td></td> <td>265 - 275 - 285 - 290 -</td> </td>	5845B160 <td>MASSEY FERGUSON</td> <td></td> <td></td> <td>265 - 275 - 285 - 290 -</td>	MASSEY FERGUSON			265 - 275 - 285 - 290 -
		1446891M91 <td>1447363M91</td> <td>298 - 365 - 375 - 390 -</td> <td></td> <td></td> <td>390T - 398 - 565 - 575 -</td>	1447363M91	298 - 365 - 375 - 390 -			390T - 398 - 565 - 575 -
				590 - 675 - 690 - 698T -			3050 - 3060 - 3065 - 3070

TR -1056		REFERENCE NO. OEM NUMBER		CAR & MODEL	ENG.	YEAR	TYPE & REMARKS
		70990177					

TR-1057		REFERENCE NO. OEM NUMBER		CAR & MODEL	ENG.	YEAR	TYPE & REMARKS
							FUEL TAP

TR -1058		REFERENCE NO. OEM NUMBER		CAR & MODEL	ENG.	YEAR	TYPE & REMARKS
		BCD1851	138044				
		DW635	7950312	BEDFORD			214/300 CU(Petrol) 19701970
		25061499	91145754				214CU(Petrol)
		25066002					Da mot.
		461-1067					100000(petrol)
						1965...	214CU(Petrol)
						1980...	EOM 214CU(Petrol)
							214CU(Petrol)
							214CU(Petrol)

FUEL PUMP

TRACTOR&PERKINS SERIES

REFERENCE NO. OEM NUMBER	CAR & MODEL	ENG.	YEAR	TYPE & REMARKS
BCD 1537/1 13H6306 25061538 25066396 461-211 7950116 7950416 7950410 7950452 7971368 808087	FP211 Austin-morris IC-012 Leyland PON 116	Gipsy Diesel,EA 350FG,360 EA FG 350,FG K30, S200 FG-FK K30,S200,350FG FGK30-60,FG350-360 WF 360,420,600,900 WFK30-40,WF360-420 WF-WFK 100 40K-461616 WF-WFK 30,40,60	BMC 2178 cc Diesel 2.2Lt Petrol 2.2Lt 2.5Lt petrol 2.2Lt Diesel 2.2Lt Petrol 4.0Lt Petrol 4.0Lt Diesel 2.5Lt Petrol 4.0Lt	1975-... 1970-... 1975-... 1970-... 1970-1974-... 1970-... 1970-... 1970-... 1970-...

REFERENCE NO. OEM NUMBER	CAR & MODEL	ENG.	YEAR	TYPE & REMARKS
BCD 1548 13H3376 461-164 7950729 7971028	Leyland 1200 FJT,1800 FJT 950FJ,1200/1700 FJT FJ-FJK100,140,160,240 FJ-FJK100,240,340 FJ-FJK300,360 FJ950,1160,1300 LR1800,1825(TRAC.UNITS) LAIRD LR1200,LR1300 LAIRD LR950,LR1000 LAIRD LR950,LR1000,LR1160	Perkins W8.510, W8.540 Diesel 5.7 Lt 5.1 Lt Diesel 5.7 Lt Horizontal Diesel 5.1 Lt Diesel 5.7 Lt Diesel 5.7 Lt Diesel 5.7 Lt Diesel 5.7 Lt Diesel 5.7 Lt 5.1 Lt Diesel 5.7 Lt	1970-... 1970-... ...-1970 ...-1970 ...-1970 1970-... ...-1973 ...-1973 ...-1973 ...-1973 ...-1973	

REFERENCE NO. OEM NUMBER	CAR & MODEL	ENG.	YEAR	TYPE & REMARKS
BCD 1647/1 25061501 25066421 258862 2641A077 35275 461-110 7950308 7950427 9.200.154 957E-9350-V	994093 Allis-Chalmers A24797A Bedford AK-007 Lucas-CAV,Delphi AK-007/1 international harvester FP110 Massey Ferguson ULPK0031 Perkins	B-272,D-272 Combine B7B,B10,200&220 TJ,TK(E)200&220 T1220 INDUSTRIALE BC 264 Tr B 275 Tr B 275 Tr & Combines Te20 Motore Industriale Motore Industriale Motore Industriale Motore Industriale(Diversi)	Perkins 3.144TA Perkins 3.144 Diesel 45775 Diesel Diesel Perkins 3.144 Benzina Perkins 3B 152 Perkins F3(Simms P4442 p4588) Perkins F3(Simms P4696) Perkins P3(Simms P4609 Spagna) Perkins P3P3.144,P3.144TA,3B.152	1962-1967 1980-... 1961-...

REFERENCE NO. OEM NUMBER	CAR & MODEL	ENG.	YEAR	TYPE & REMARKS
BCD 1660/1 5037661 2400E-9350-A 35205 461-108 7950421 7950607 994074 AK-042 AK-042/1	Beardmore Taxi Dodge PB Massey Ferguson Tr.630 Perkins Motore Industriale(Diversi) Talbot PA PB	Perkins P4/99 Perkins 4.108 Perkins A4.107 Perkins 4/99-A4.107 Perkins 4.108 Perkins 4.108-...108U13472	1967-... 1965-... ...-1967 1965-...	

REFERENCE NO. OEM NUMBER	CAR & MODEL	ENG.	YEAR	TYPE & REMARKS
BCD 1666/5 1.518.004 3.518.0002A 3.518.001	Slanzi Motore Industriale VM Motori Motore Industriale Motore Industriale Motore Industriale	DVA 1000 VM Motori 100 SL VM Motori 104,106 SL VM Motori 954,956 SL	...-1965 ...-1965	

REFERENCE NO. OEM NUMBER	CAR & MODEL	ENG.	YEAR	TYPE & REMARKS
BCD 1702/5 100,9443 30424 50030424	Axeco(Axerio) A103B,A103C,D32 Carraro A55,A75,A103 Trattore	300		

REFERENCE NO. OEM NUMBER	CAR & MODEL	ENG.	YEAR	TYPE & REMARKS
BCD 1745/2 25066034 2641376 461-144 7950833	Dennis Heron Chassis	Perkins 4.203		

FUEL PUMP

TRACTOR&PERKINS SERIES

REFERENCE NO. OEM NUMBER	CAR & MODEL	ENG.	YEAR	TYPE & REMARKS
BCD 1756/2 25061507 25066063 35218 461-123 7950621 AK-105	Hyster H40 F Massey Ferguson MF 155 Perkins Motore Industriale	Perkins 4.203.1 Perkins AD4.203 Perkins 4.203,4.203TA,4.192		

REFERENCE NO. OEM NUMBER	CAR & MODEL	ENG.	YEAR	TYPE & REMARKS
BCD 1758/2 461-205 7971320	Alsthoen Dieselair Agrom	Alsthoen Dieselair2 ,3,4,5,6cil		

REFERENCE NO. OEM NUMBER	CAR & MODEL	ENG.	YEAR	TYPE & REMARKS
BCD 1785/5 25061509 25066414 461-129 7950728 POC 671	Bedford Beagle Estate Car Vauxhall HA van 6/8 cwt Firenza Viva HB Viva HXC	1159,1256	1965-... 1965-... 1970-1972 1966-1970 1970-1972	

REFERENCE NO. OEM NUMBER	CAR & MODEL	ENG.	YEAR	TYPE & REMARKS
BCD 1808/6 25061504 25066375 461-114 708 294 R 93 7950454 FP114	International 354 Harvester 444 B-250,B-275 B-414 B-434 B-450 Motore agricolo Motore agricolo	IH(International Harvester)BD-144A,2.4Lt IH(International Harvester)BD-154A,2.5Lt IH(International Harvester)BD-144,2.4Lt IH(International Harvester)BD-154,2.5Lt IH(International Harvester)BD-154,2.5Lt IH(International Harvester)BD-144,2.4Lt IH(International Harvester)BD-154,2.5Lt	1971-1975 1971-1975 1955-1966 1961-1965 1966-1969	

REFERENCE NO. OEM NUMBER	CAR & MODEL	ENG.	YEAR	TYPE & REMARKS
BCD 1822 25061521 25061568 25066399 461-168 461-267 7950746 7971043 7990271 944997 K944997	Casw-IH 1190,1290,1390, 1490,1690, 1290,1390 David Brown 1490, 1690, 580G 990,1200,1400 Serie 900 990,995,996 Selectamatic Rover Tr.1390,1490,1690 Tr.1x58,1190,1290 2000 SC TC 2200	David Brown David Brown	1975-... 1980-1983 1979-1983 1979-1982 1974-... 1976-1980 1975-... 1974-... 1963-1974 1974-1976	

REFERENCE NO. OEM NUMBER	CAR & MODEL	ENG.	YEAR	TYPE & REMARKS
BCD 1838/6 4.6585.054 4850.34 4850.38 4850.41 RIF-codice 4850.46 6585.054	Slanzi Motore Industriale Motore Industriale Motore Serie 100	DVA 1550 S2,1750 S,2700 DVA 3600,3600 TB,2350 DVA 460,515,1500,1750		

REFERENCE NO. OEM NUMBER	CAR & MODEL	ENG.	YEAR	TYPE & REMARKS
BCD 1839/5 4850.36 4850.39 4850.42 6585.052	Slanzi Motore Industriale	DVA 700,790,920,1030		

FUEL PUMP

TRACTOR&PERKINS SERIES

REFERENCE NO. OEM NUMBER	CAR & MODEL	ENG.	YEAR	TYPE & REMARKS
BCD 1847	Bedford	HRX,KM,TK	466 Diesel	1968-...
25061558	T,VA,W Autotelaio	466 Diesel		1968-...
25066385	TK,HRX,KM Truck	466 Diesel		1970-...
461-255	Y Autotelaio	466 Diesel		1968-...
7950913				
7990032				
7990138				
8.160.41				
91145756				
FP255				

TR1073 IN 1/2"-20 UNF OUT 1/2"-20 UNF

REFERENCE NO. OEM NUMBER	CAR & MODEL	ENG.	YEAR	TYPE & REMARKS
BCD 1851	Bedford	C,TJ	214/300 CU(Petrol)	1970
25061499	P Autotelaio		214 CU(Petrol)	
25066002	TA 4-5 Ton.		da Mot.10000(Petrol)	
461-106	TC,TD,TJ		214 CU(Petrol)	
7138044	TK		EOM 214 CU(Petrol)	1965-...
7950312	TL		214 CU(Petrol)	1980-...
91145754	VA Autotelaio		214 CU(Petrol)	

TR-1074 IN 1/2"-20 UNF OUT 1/2"-20 UNF

REFERENCE NO. OEM NUMBER	CAR & MODEL	ENG.	YEAR	TYPE & REMARKS
BCD 1858	Arbos	Applicazioni varie	Perkins 4.236	
25061584	Aveling-Barford	GN Tr3 DG/PTR	Perkins 4.236	
25066386	Avtoexport	Gaz 53	Perkins 4.236	
2641338	Berliet	550K	Perkins 4.236	
2641477	Bristol	Compressore	Perkins 4.236	
2641478	Broome & Wade	CA2/3	Perkins 4.236	
3726067	Clark	Dc70	Perkins 4.236	
461-283	Consol.Pneumatic	Compressore 125-RO-1	Perkins 4.236	
461-284	Conveyancer	Tc7 Series	Perkins 4.236	
5082037	Daf	FA 500,FA 700	Perkins 4.236	
7480325	Dronningborg	Applicazioni varie	Perkins 4.236	
7971135	Epple Buxbaum	Applicazioni varie	Perkins 4.236	
7990440	hobart	H110-150F	Perkins 4.236	
7990439	Hyster	DR 125/140/150	Perkins 4.236	
910574	Ingersoll	Applicazioni varie	Perkins 4.236	
FP284	Johnston Bros	O4 Mobile Crane	Perkins 4.236	
	Jones Cranes	800	Perkins 4.248	
	Landini	Combine	Perkins 4.236	
	Laverda	Macchina Agricola MF 33	Perkins 4.248	
	Massey Ferguson	M11	Perkins 4.248	
		MF 165 Combine	Perkins 4.212	
		MF 178,185,188	Perkins 4.248...248UA71960	
		MF 186 Combine	Perkins 4.212	
		MF 300	Perkins 4.248	
		MF 457 Combine	Perkins 4.248	
		MF 50 Phase II skid	Perkins 4.212	
		Tr.175/175S,175/178	Perkins 4.212	
	Perkins	Tr.Industr.MF 30/50	Perkins 4.236	
	Rossi	Motore Industriale	Perkins 4.212,4.236,4.238	
	Talbot	Machine Agricole	Perkins 4.236	
	Volvo	Walk Thru 50	Perkins 4.236	
		F 82,F 83	Perkins 4.236	

TR -1075 IN 1/2"-20 UNF OUT 1/2"-20 UNF

REFERENCE NO. OEM NUMBER	CAR & MODEL	ENG.	YEAR	TYPE & REMARKS
BCD 1860/5	VM Motori	Motore Industriale	VM Motori 295 e derivati	...-1980
1.518.007		Motore Industriale	VM Motori 395 e derivati	...-1980
1.518.009				
8500128				

TR -1076 IN M14x1.5 OUT M14x1.5

REFERENCE NO. OEM NUMBER	CAR & MODEL	ENG.	YEAR	TYPE & REMARKS
BCD 1861/5	VM Motori	Motore Industriale	VM Motori 102 SU,103 SU	...-1980
1.518.003		Motore Industriale	VM Motori 104 SU(2,3,4 Cil)	...-1980
1.518.006		Motore Industriale	VM Motori 398	...-1980
1.518.010		Motore Industriale	VM Motori 952 SU,953 SU	...-1980
8500121				

TR -1077 IN M14x1.5 OUT M14x1.5

REFERENCE NO. OEM NUMBER	CAR & MODEL	ENG.	YEAR	TYPE & REMARKS
BCD 1863/1	Clark	C60/70/80B'CY40/60	MF 590X,5955	Perkins 4.203 Perkins 4.318
25061530	Eicher	(3355,3356)	MF 592	Perkins 4.203 Perkins 4.318,4.318.2
2641333	Fenwick	FLT	MF595	Perkins 4.203 Perkins 4.318
2641336	Hyster	H40 H Applicazioni varie	MF 598	Perkins 4.203 Perkins A4.318,4.203
461-193	Lancer Boss	TL 16N	Motore Industriale	Perkins D4.203 Perkins 4.203
7971262	Landini	MF 1080 PhasE III	TC SERIE	Perkins 4.318 Perkins 4.203
911287	Massey Ferguson	MF 155,158	FLT	Perkins 4A.203 Perkins 4.203
AK-107	Perkins	MF195	FLT D51 AT40	Perkins 4.318
ULPK0010	Rubery Owen	MF260		Perkins D4.203
	Valmet	MF295,298		Perkins 4.318
	Yale & Towne	MF560		Perkins 4.203 Perkins 4.318

TR -1078 IN 1/2"-20 UNF OUT 1/2"-20 UNF

FUEL PUMP

TRACTOR&PERKINS SERIES

REFERENCE NO. OEM NUMBER	CAR & MODEL	ENG.	YEAR	TYPE & REMARKS
BCD 1877/1	Austin-Morris	Taxi	BMC Diesel 1.5-1.8 Lt	1966-...
25061525	Buhrer	TR2200K,TR2500K	Ldyland Diesel 1.5 Lt	
25066394	Leyland	FX-4(Taxi)	Diesel 1.5-1.8 Lt	1966-...
281756		JU 250,J2,J4 180	Diesel	1968-1974
461-176		Sherpa 185,215,240	Diesel 1.8 Lt	1967-1978
62H557				
7971139				
807787				
FP176				
IC-005				

TR -1079 IN 1/2"-20 UNF OUT 1/2"-20 UNF

REFERENCE NO. OEM NUMBER	CAR & MODEL	ENG.	YEAR	TYPE & REMARKS
BCD 1881	David Brown	990,1200	4 cil.Diesel	1967-1973
25061515				
461-148				
7950899				
B909944				

TR-1080 IN 1/2"-20 UNF OUT 1/2"-20 UNF

REFERENCE NO. OEM NUMBER	CAR & MODEL	ENG.	YEAR	TYPE & REMARKS
BCD 1899/5	Lombardini	Motore Industriale	Lombardini 8LD 600 8LD602 (Gr.8)	
9.06.233.11		Motore Industriale	Lombardini 904 Diesel e derivati,914	
904.6585.022				
904.6585.22				

TR-1081 IN M10x1.0 OUT M10x1.0

REFERENCE NO. OEM NUMBER	CAR & MODEL	ENG.	YEAR	TYPE & REMARKS
BCD 1902/5	Lister Petter	Motore serie SR	Lister Petter Serie SR	
25061552				
351-12151				
352-83780				
461-240				
572-71982				
7990046				
FP240				

TR -1082 IN 1/2"-20 UNF OUT 1/2"-20 UNF

REFERENCE NO. OEM NUMBER	CAR & MODEL	ENG.	YEAR	TYPE & REMARKS
BCD 1905/5	Lister Petter	Diesel Air Cooled	Lister Petter HA,HB LD,LS	
25061505		Motore serie ST	Lister Petter ST1,ST2,ST3	
25066373				
323939				
329-24810				
329-62200				
351-12150				
461-115				
572-71980				
RIF-codice				
7950461				
FP115				

TR -1083 IN 1/2"-20 UNF OUT 1/2"-20 UNF

REFERENCE NO. OEM NUMBER	CAR & MODEL	ENG.	YEAR	TYPE & REMARKS
BCD 1921/6	VM Motori	Motore Industriale	VM Motori D 703 L-LT-LTS	...-2000
1.518.0016A		Motore Industriale	VM Motori HR 288,HR 388H	
1.518.0016F		Motore Industriale	VM Motori HR 292,HR 392H	
1.518.0016G		Motore Industriale	VM Motori HR 394HP,HR 3394HPT	
1.518.012				
1.518.016				

TR -1084 IN M14x1.5 OUT M14x1.5

REFERENCE NO. OEM NUMBER	CAR & MODEL	ENG.	YEAR	TYPE & REMARKS
BCD 1922/6	Talbot	Matra Murena	1.6 Lt	09.80-...
8101		Solara (Senza ricircolo carb.)	1.6 Lt	1982-...
9.06.286.11				
91537966-90				
97533382.8				04.80-1986
BC-102				
CZ-028				
PL 3101				
PL 3101				
POC 303				
POC 624				
POC 670				
RE0034564				

TR-1085 IN Dia.6 OUT Dia.6

FUEL PUMP

TRACTOR&PERKINS SERIES

REFERENCE NO. OEM NUMBER	CAR & MODEL	ENG.	YEAR	TYPE & REMARKS
BCD 1924/5	VOLVO 240	2.0-2.1-2.3 Lt	1974-1991	
1116185	242,244,245	B 21 A	09.74...	
1219733	340	2.0 Lt	1980-1984	
1266141	8401	2.0 Lt	1985-1989	
1306877	360	2.0 Lt	1980-1985	
1317435	740	2.0-2.3 Lt	1984-1990	
1336185				
13361852				
247075				
3411				
463348				

TR-1086 IN Dia.8 OUT Dia.6

REFERENCE NO. OEM NUMBER	CAR & MODEL	ENG.	YEAR	TYPE & REMARKS
BCD 1927/5	Lombardini Motore Industriale	Lombardini gruppo 5-7-9-10-11 Diesel		
276.6585.030	Motore Industriale	Lombardini LDA 672,LDA 673 Diesel		
276.6585.11	Motore Industriale	Lombardini LDA 832,LDA 833 Diesel		
276.6585.30				
6416.6585.07				
6585.11				
672.6585.030				
9.06.232.11				
AS-050				
AS-050/2				
POC 105				

TR -1087 IN M12x1.0 OUT M12x1.0

REFERENCE NO. OEM NUMBER	CAR & MODEL	ENG.	YEAR	TYPE & REMARKS
BCD 1928/5	Ferrari Goldoni Lombardini	Motocoltivatori 72,72 Super		
283.6585.031		Motofalciatrici 702,703,705		
AS-050/3		Tr.MC60,MC60RT		
POC 104		Motocoltivatori Export		
		Motocoltivatori Speciali		
		Motore Industriale	Lombardini 3LD 450 Diesel	
		Motore Industriale	Lombardini 500,503,505,507 Diesel	
		Motore Industriale	Lombardini 520,523,525,527 Diesel	
		Motore Industriale	Lombardini LD 450(Gruppo 3-4) Diesel	
		Motore Industriale	Lombardini LDA80, LDA80B Diesel	
		Motore Industriale	Lombardini LDA 96 e derivati Diesel	

TR -1088 IN 1/2"-20 UNF OUT 1/2"-20 UNF

REFERENCE NO. OEM NUMBER	CAR & MODEL	ENG.	YEAR	TYPE & REMARKS
BCD 1933/1	Bedford	C Truck(300 CU)	S6000001-6116935	...-1970
25061497		R Truck	24985...	
25066001		S Truck	36160...	
461-104		SB	24733-616935	
7950082		TC Truck	300 CU	
		TD Truck	300 CU	
		TK Truck(EOM-N-Q-R-T-V)HR	300 CU	
		VA Autotelaio	X3-300 CU...6116	
			300 CU	

TR -1089 IN 1/2"-20 UNF OUT 1/2"-20 UNF

REFERENCE NO. OEM NUMBER	CAR & MODEL	ENG.	YEAR	TYPE & REMARKS
BCD 1934/5	Bedford	Chevanne	1.3 Lt	1976-...
25061579	Vauxhall	Cavalier	1.3 Lt	08.76-1979
461-277		Chevette	1256 cc 1.3 Lt	1975-...
7971483		Viva HC		1974-...
7990375				
POC 676				

TR -1090 IN 1/2"-20 UNF OUT 1/2"-20 UNF

REFERENCE NO. OEM NUMBER	CAR & MODEL	ENG.	YEAR	TYPE & REMARKS
BCD 1941/5	Nissan(Datsun)	Ebro Patrol 2700 Diesel	P.MD 270(Spagna)2.7Lt	
25061574	AK-099	All Volkswagen	Perkins 4.165	
25066418	AK-099/0	Motore Industriale	Perkins 4.165(Spagna)	
2641706	FP303	230/313 Diesel	Perkins 4.165	
2641723	Volkswagen	LT28D,LT31D,LT35D	Perkins 4.165	
2641809				
43/002				
461-303				
74800012-0				
74800019-0				

TR -1091 IN 1/2"-20 UNF OUT 1/2"-20 UNF

REFERENCE NO. OEM NUMBER	CAR & MODEL	ENG.	YEAR	TYPE & REMARKS
BCD 1958/5	VM Motori	Motore Industriale	VM Motori 298 SU	1981-...
1.518.0018A				
1.518.0018F				

TR-1092 IN M14x1.5 OUT M14x1.5

FUEL PUMP

TRACTOR&PERKINS SERIES

REFERENCE NO. OEM NUMBER	CAR & MODEL	ENG.	YEAR	TYPE & REMARKS
BCD 1959/6	VM Motori	Motore Industriale	VM Motori 1052	1981-...
1.518.0017A		Motore Industriale	VM Motori SU-SUN 2-3-4 CIL	
1.518.0017F		Motore Industriale	VM Motori SUN 2105-3105	
1.518.0017G		Motore Industriale	VM Motori SUN 4105-6105	

TR -1093 IN M14x1.5 OUT M14x1.5

REFERENCE NO. OEM NUMBER	CAR & MODEL	ENG.	YEAR	TYPE & REMARKS
BCD 1963/1	Applicazioni varie			

TR -1094 IN Dia.8 OUT Dia.6

REFERENCE NO. OEM NUMBER	CAR & MODEL	ENG.	YEAR	TYPE & REMARKS
BCD 1966/5	Ruggerini	Motore Industriale	Ruggerini RD/2,RD180,MD350	
00652R0110		Motore Marino	Ruggerini'FIDO P.D.I.'	
00652R0240				
652.11				
652.24				
652R.011				
FT-300				
POC 108				
PX-300				

TR -1095 IN M10x1.0 OUT M10x1.0

REFERENCE NO. OEM NUMBER	CAR & MODEL	ENG.	YEAR	TYPE & REMARKS
BCD 1967/5	Ruggerini	Motore Industriale	Ruggerini RD/2,CRD/2,RD180,MD350	
00652R0120		Motore Marino	Ruggerini'FIDO P.D.I.'	
00652R0250				
450139				
50291600.82				
652.12				
652.18				
652.25				
652R.012				
FT-301				
POC 107				
RF -codice				
PX-703				

TR -1096 IN M10x1.0 OUT M10x1.0

REFERENCE NO. OEM NUMBER	CAR & MODEL	ENG.	YEAR	TYPE & REMARKS
BCD 1971/6	Aebi	Terratrac T1170	VM Motori D 754 E2 3.0Lt/50 kw	
1.518.0019A	Alfa Romeo	164	Turbodiesel 2.5 Lt	
1.518.0019F	Rover	Ranger Rover	2495 cc Diesel-Turbodiesel 2.5 Lt	
1.518.0019G		Ranger Rover 2/4 porte	Diesel Turbodiesel	
605.13562		Ranger Rover 90,110(t.L.)	VM Motori HR 2.4Lt	
PON 101	VM Motori	Rover 2400 SD Turbo	VM Motori D 754E2(*2970 cc)	
		Motore	VM Motori HR 388,HR 388H,HR 388 HT	
		Motore Industriale	VM Motori HR 392,HR 392H,HR 392HT	
		Motore Industriale	VM Motori HR 492 Leyland	

TR -1097 IN M14x1.5 OUT M14x1.5

REFERENCE NO. OEM NUMBER	CAR & MODEL	ENG.	YEAR	TYPE & REMARKS
BCD 1973	National	Octopus 30T	502	1971-...
D8NN-9350-AB	Reiver		502	1971-...
FP314	Viking EVK 55		401,410	
LM831637	Intapak,PT Revopak		401	
	Sisu Siesel	BX84B0 City Autotel,500Turbo	Leyland 401,410	
	Volvo	LM621,LM641,LM4300	Leyland	1979-...

TR -1098 IN 1/2"-20 UNF OUT 1/2"-20 UNF

REFERENCE NO. OEM NUMBER	CAR & MODEL	ENG.	YEAR	TYPE & REMARKS
BCD 2644/1	VM Motori	Motore Industriale	VM Motori D 704-LT	
1.518.2006F		Motore Industriale	VM Motori D 706LT	
1.518.2006G		Motore Industriale	VM Motori HR 394H,HR 394HT	
		Motore Industriale	VM Motori HR 494H,HR 494HT	
		Motore Industriale	VM Motori HR 694HT	

TR -1099 IN M14x1.5 OUT M14x1.5

FUEL PUMP

TRACTOR&PERKINS SERIES

REFERENCE NO. OEM NUMBER	CAR & MODEL	ENG.	YEAR	TYPE & REMARKS
BCD 2521/5 1.518.2001A 546 448 PON 123	Alfa Romeo Alfa 33, Sport Wagon VM Motori Motore Industriale Motore Industriale	Turbodiesel 1.8 LT VM Motori HR 292,HR 292H,HR 292HT VM Motori HR 294,HR 294H,HR 294HT		
TR-1100	IN M14x1.5	OUT M14x1.5		
REFERENCE NO. OEM NUMBER	CAR & MODEL	ENG.	YEAR	TYPE & REMARKS
BCD 2522/6 25066408 2641722 2641722/3 2641A054 3860 461-311 905828 93151022	Balkancar Caterpillar- Mitsubishi Clark Coventry Climax Eaton Yale Eicher Fenwick Hyster Massey Ferguson Perkins	Lmpex V40-60C C500Y-40-060 PD DA 2.5 3,4 Ton 4060(3355,33560 Applicazioni varie H60-80C MF 155, 158,260,560 Motore Industriale Motore Industriale	Perkins 4.203.2 Perkins 4.203.2 Perkins 4.203.2 Perkins 4.203.2 Perkins 4.203.2 Perkins 4.203.2 Perkins 4.203.2(France) Perkins 4.203.2 Perkins D4.203 Perkins 4.203.2 Perkins D4.203	1978-1980
TR-1101	IN 1/2"-20 UNF	OUT 1/2"-20 UNF		
REFERENCE NO. OEM NUMBER	CAR & MODEL	ENG.	YEAR	TYPE & REMARKS
BCD 2532/6 4850,47 6585,055 9.06.061.11	Goldoni Slanzi	Tr.224 Motore Industriale	Slanzi DVA 920 DVA 920	
TR-1102	IN M10x1.0	OUT M10x1.0		
REFERENCE NO. OEM NUMBER	CAR & MODEL	ENG.	YEAR	TYPE & REMARKS
BCD 2558 30332 30333 50030332	Carraro	Carro 4500 CS Industriale Industriale Tr.502,504 Tr.602,604 Tr.650 DT,655 CL Tr.702,704 Tr.952,954 Victory 7100 N & 4RM Victory 7500 N & 4RM Victory 9800 DF & 8800	285,315,425,505,575 285,315,430,515,340 450DT,452DT,454,455C,500 285 315 425 505 575 425 505 575	1966-1968 1973... 1973... 1973... 1973... 1973... 1973...
TR -1103	IN M14x1.5	OUT M14x1.5		
REFERENCE NO. OEM NUMBER	CAR & MODEL	ENG.	YEAR	TYPE & REMARKS
BCD 2560 25061599 25066384 461-317 8.160.43 91145753 93151041 FP317	Bedford General Motors	DM/TL 500 Turbo TK Turck 500Turbo DM Diesel 500 Turbo	Diesel Diesel	1980-... 1980-...
tr -1104	IN 1/2"-20 UNF	OUT 1/2"-20 UNF		
REFERENCE NO. OEM NUMBER	CAR & MODEL	ENG.	YEAR	TYPE & REMARKS
BCD 2561 25061541 461-216 7971397	Bedford	C Truck(Petrol) TJ,TK Truck(Petrol)	300 6116936... 300+compressore	
TR -1105	IN 1/2"-20 UNF	OUT 1/2"-20 UNF		
REFERENCE NO. OEM NUMBER	CAR & MODEL	ENG.	YEAR	TYPE & REMARKS
BCD 2568 25061616 25066419 2641726 461-346 93151295	Perkins	Motore Industriale	Perkins G4.236 Benzina	
TR -1106	IN 1/2"-20 UNF	OUT 1/2"-20 UNF		

FUEL PUMP

TRACTOR&PERKINS SERIES

REFERENCE NO. OEM NUMBER	CAR & MODEL	ENG.	YEAR	TYPE & REMARKS
BCD 2601 994185 AK-085	Motor Iberica Applicazioni varie	Perkins D3.152		
TR -1107	IN 1/2"-20 UNF	OUT 1/2"-20 UNF		
REFERENCE NO. OEM NUMBER	CAR & MODEL	ENG.	YEAR	TYPE & REMARKS
BCD 2604 10940 212859 25061535 25066426 461-152 461-208 7950390 7950993 7971355	Allis-Chalmers Bond Reliant	ED-40 Bug Robin(MK1)	0.7Lt Reliant 750 cc 0.75 Lt	1970-1974 1973-1975
TR -1108	IN 1/2"-20 UNF	OUT 1/2"-20 UNF		
REFERENCE NO. OEM NUMBER	CAR & MODEL	ENG.	YEAR	TYPE & REMARKS
BCD 2609/1 25066422 461-299 7990262	Petters	Motore Industriale	PH,PJ	
TR -1109	IN 1/2"-20 UNF	OUT 1/2"-20 UNF		
REFERENCE NO. OEM NUMBER	CAR & MODEL	ENG.	YEAR	TYPE & REMARKS
BCD 2614 74800022-0 994184 994294 AK-084	Motor Iberica	Industriale	Perkins 3.152	
TR- 1110	IN 1/2"-20 UNF	OUT 1/2"-20 UNF		
REFERENCE NO. OEM NUMBER	CAR & MODEL	ENG.	YEAR	TYPE & REMARKS
BCD 2617 994105 AK-060	Motor Iberica	Industriale	Perkins 4.203	
TR-1 112	IN 1/2"-20 UNF	OUT 1/2"-20 UNF		
REFERENCE NO. OEM NUMBER	CAR & MODEL	ENG.	YEAR	TYPE & REMARKS
BCD 2620 748000-0 994133 994271 AK-066 AK-066/0	Motor Iberica	Industriale	Perkins 6.354.3	
TR -1113	IN 1/2"-20 UNF	OUT 1/2"-20 UNF		
REFERENCE NO. OEM NUMBER	CAR & MODEL	ENG.	YEAR	TYPE & REMARKS
BCD 2641/1 1173650	Volvo	T650,T700		
TR -1114	IN 1/2"-20 UNF	OUT 1/2"-20 UNF		

FUEL PUMP

JOHN DEERE SERIES

JD-1001	IN Z1/8"-27 NPT OUT1/8"-20 NPT	REFERENCE NO. OEM NUMBER		CAR & MODEL	ENG.	YEAR	TYPE & REMARKS
		FP66	RE27667				
		BCD 1943/1	FP66	JOHN DEERE (EUROPA)	1120,1130,1140,1630	...1989	Industriale
		3969	RE37482		1640		
		5507919	AR49770		1830,1840,2020,2030	...1989	Industriale
		AR77914	AR52159		2040s		
		AR92777	CX-020		2120,2130,2140,3030	...1989	Industriale
		DD13483	DD14195		3040		
		DE16748	DD14792		3120,3130,3140,3640	...1989	Industriale
		FP1700	FP911		4040s		
					3,4,6cil.Diesel	...1989	Industriale
					940,1020,1030,1040	...1989	Industriale

JD-100 2	IN Z1/8"-27 NPT OUT1/8"-20 NPT	REFERENCE NO. OEM NUMBER		CAR & MODEL	ENG.	YEAR	TYPE & REMARKS
		FP66	RE27667				
		BCD 1943/1	FP66	JOHN DEERE (EUROPA)	1120,1130,1140,1630	...1989	Industriale
		3969	RE37482		1640		
		5507919	AR49770		1830,1840,2020,2030	...1989	Industriale
		AR77914	AR52159		2040s		
		AR92777	CX-020		2120,2130,2140,3030	...1989	Industriale
		DD13483	DD14195		3040		
		DE16748	DD14792		3120,3130,3140,3640	...1989	Industriale
		FP1700	FP911		4040s		
					3,4,6cil.Diesel	...1989	Industriale
					940,1020,1030,1040	...1989	Industriale

JD-1003	IN Ø8 OUT Ø8	REFERENCE NO. OEM NUMBER		CAR & MODEL	ENG.	YEAR	TYPE & REMARKS
		CX-021	RE38009				
		BCD 2659		JOHN DEERE (EUROPA)	Industriale	1990...	1120,1130,1140,1640
		8969		JOHN DEERE (EUROPA)	Industriale	1990...	1830,1840,2020,2030,2040s
		CX-021		JOHN DEERE (EUROPA)	Industriale	1990...	2120,2130,2140,3030,3040
		RE38009		JOHN DEERE (EUROPA)	Industriale	1990...	3120,3130,3140,3640,4040s
				JOHN DEERE (EUROPA)	Industriale	1990...	3,4,6cil.Diesel
				JOHN DEERE (EUROPA)	Industriale	1990...	940,1020,1030,1040
				JOHN DEERE (EUROPA)	Industriale	1990...	

JD-100 4	IN Ø8 OUT Ø8	REFERENCE NO. OEM NUMBER		CAR & MODEL	ENG.	YEAR	TYPE & REMARKS
		RE66153	RE535728				
				JOHN DEERE (EUROPA)			

JD-100 5	IN 9/16"-24 UNF OUT9/16"-24 UNF	REFERENCE NO. OEM NUMBER		CAR & MODEL	ENG.	YEAR	TYPE & REMARKS
		RE66153	RE535728				
				JOHN DEERE (EUROPA)			

JD-1006		REFERENCE NO. OEM NUMBER		CAR & MODEL	ENG.	YEAR	TYPE & REMARKS
		RE68345					
				JOHN DEERE			

JD-1007		REFERENCE NO. OEM NUMBER		CAR & MODEL	ENG.	YEAR	TYPE & REMARKS
		AM882588	877674				
				JOHN DEERE 4500			

FUEL PUMP

DEUTZ SERIES

DZ-1001	IN M14x1.5 OUT M14x1.5	REFERENCE NO. OEM NUMBER		CAR & MODEL	ENG.	YEAR	TYPE & REMARKS
		7.15252.51	7.15252.52				
		BCD1662/7		KHD (DEUTZ)	B/F3,4,5,6 L912/913WT	1964...	Industriale
		2100087			F2L912	3/1984...	
		2134511	PON120		F3L 812D,F3L 912/912W	1964...	
		4150197			F3L913		
		415 7603			F4L 812 D,F4L 912/91W		
		416 7698			F5L 912/912W,912D	1964...	
		423 1021			F6L 812D,F6L 912/912W	1964...	
		4230566		VM	104,106,954,956 SU	1964...	
		7.15252.01			1056,T1056SU,6105		
		7.15252.50			T6105 SUN		

D Z-1002	IN M14x1.5 OUT M14x1.5	REFERENCE NO. OEM NUMBER		CAR & MODEL	ENG.	YEAR	TYPE & REMARKS
		7.20546.50	7.20546.51				
		BCD 1960/5		KHD(DEUTZ)	Industriale	4/1979...	F1/2 FL 511
		117 2781	KZ 8947-10	KHD(DEUTZ)	Industriale	1965...	F1/2L 410
		117 2782	PX-105	KHD(DEUTZ)	Industriale		F2L 511
		117 3937					
		126 0045					
		415 7223					
		7.15532.00					
		7.15532.50					

D Z-1003	IN M14x1.5 OUT M14x1.5	REFERENCE NO. OEM NUMBER		CAR & MODEL	ENG.	YEAR	TYPE & REMARKS
		UT6-048					
				DODGE KHD (DEUTZ)			

DZ-1004	IN Ø8 OUT Ø8	REFERENCE NO. OEM NUMBER		CAR & MODEL	ENG.	YEAR	TYPE & REMARKS
		4179734	4271682				
				KHD(DEUTZ)			FL 1011,2011 TURBO
		4272616					Industriale
		PX111					

DZ-1005	IN M14x1.5 OUT M14x1.5	REFERENCE NO. OEM NUMBER		CAR & MODEL	ENG.	YEAR	TYPE & REMARKS
		BCD 1669/5	FENDT				
		6.0520.19.00004	RENAULT TRUCKS	MWM D225-6(90 HP)			
		7.15509.50	STEYR	208,308(19,84 HP)			
		F150.204.710011	Schlepp FW 528	208,308(19,84 HP)			
		F150.204.710012		MWM D226 (22,125 HP)			
		130100080733	Industrial	MWM D301-2(20 HP)			
		140100080709	Industrial	MWM D302(7,27 HP)			
		140100080702	Industrial	MWM D327(20,112 HP)			
			Industrial	MWM TD208(70,90 HP)			
			Industrial	MWM TD226-6(100,150 HP)			
				MWM D322			

DZ-1006		REFERENCE NO. OEM NUMBER		CAR & MODEL	ENG.	YEAR	TYPE & REMARKS
		BCD 1969/5					
				KHD(DEUTZ)	FL 912,FL 912W	1958-...	Motore industrial
		0126 0044					
		0126 0140					
		7.15547.50					
		KZ 8747-10					
		PX-106					

DZ-1007		REFERENCE NO. OEM NUMBER		CAR & MODEL	ENG.	YEAR	TYPE & REMARKS
		BCD2680	FENDT				
		01756122	MWM	MWM D236 (50-65-75 HP)		01.75-...	Industrial
		175 6122		MWM D226(36-47-54 KW)		01.75-...	Industrial
		1756122					
		6 0520 19 0 0013					
		60 05 007 513					
		60.05.027.558					
		F278.201.710.400					
		GR-030					

FUEL PUMP

DEUTZ SERIES

DZ-1008		REFERENCE NO. OEM NUMBER	CAR & MODEL	ENG.	YEAR	TYPE & REMARKS
		BCD1981/5 0200 22201 3055 375 R 92 3055 375 R 93 3132 697 R 91 3132 697 R 92 3142 697 R 91 7.15524.00 7.15567.00 7.15567.50	CASE-IH	IH D358(101 PS) DT 358(125 PS) DT 402(145 PS) IH D 358(101 PS) S 358(101 PS) IH D358(103 PS) IH D358(103 PS) DT 358(135 PS) DT 402(136 PS) IH D 206(CAV PUMP)3.4LT IH D 239(67-72 PS) IH D 239(CAV PUMP)3.9LT IH D 310.D 358 (90 PS) DT...(144 PS)	04.68-... 04.68-... 04.68-... 04.68-... 04.68-... 04.68-... 04.68-... 1990-1993 1990-1993 04.68-... 04.68-... 04.68-...	1055 1255 1455 630YUMBO 630W YUMBO 640.640LN 640HDN YUMBO 650 YUMBO 650HD YUMBO 740 743 XL 840 955 FORESTALE S-10A

DZ -1009		REFERENCE NO. OEM NUMBER	CAR & MODEL	ENG.	YEAR	TYPE & REMARKS
		BCD 1681/5 2.4519.130.0	Same Deutz-Fahr Atlanta 45 Centaurio 60, Leone 70			

IN M14x1.5 OUT M14x1.5

DZ-1010		REFERENCE NO. OEM NUMBER	CAR & MODEL	ENG.	YEAR	TYPE & REMARKS
		BCD 1771/5 2.4519.020.0	Same Deutz-Fahr Sametto, Samitalia			

IN M10x1.0 OUT M10x1.0

DZ -1011		REFERENCE NO. OEM NUMBER	CAR & MODEL	ENG.	YEAR	TYPE & REMARKS
		BCD 1910/5 003.8319.6 003.8319.6/10 2.4519.160.0 2.4519.190.0 2.4519.190.0/10 2.4519.190.0/11 9.06.069.11 FT-100	Itma Lamborghini] Same Deutz-Fahr	A352 A503 C 553, C 653 R 235 R 654, R 854 Aurora, Minitauro Corsaro, Falcon, C Delfino, Sirenetta Saturno	Same Deutz-Fahr 2 cil Same Deutz-Fahr 3 cil Same Deutz-Fahr 3 cil Same Deutz-Fahr 2 cil Same Deutz-Fahr 4 cil Same Deutz-Fahr 3 cil 4 cil 2 cil 4 cil	

IN M14x1.5 OUT M14x1.5

DZ -1012		REFERENCE NO. OEM NUMBER	CAR & MODEL	ENG.	YEAR	TYPE & REMARKS
		BCD 1911/5 2.4519.120.0 2.4519.140.0 2.4519.150.0 2.4519.180.0 2.4519.200.0 2.4519.200.0/10	Lamborghini] Same Deutz-Fahr	R 1056 Bufalo 130 drago Panther Tiger	Same Deutz-Fahr 6 cil 6 cil Same Deutz-Fahr 6 cil Same Deutz-Fahr 5 cil Same Deutz-Fahr 5 cil	

IN 1/2"-20 UNF OUT 1/2"-20 UNF

DZ -1013		REFERENCE NO. OEM NUMBER	CAR & MODEL	ENG.	YEAR	TYPE & REMARKS
		BCD 1930/5 2.4519.220.0 2.4519.230.0 2.4519.230.0/10 2.4519.290.0 FT-102	Hurlimann Lamborghini Same Deutz-Fahr	H6160 1056 Bufalo 130 Condor Sincro 55 Drago 120 Motore Industriale Panther 90 Tiger 100	Same Deutz-Fahr 6 cil 6 cil 6 cil Same Deutz-Fahr 5 cil Same Deutz-Fahr 5 cil	

IN M14x1.5 OUT M14x1.5

DZ -1014		REFERENCE NO. OEM NUMBER	CAR & MODEL	ENG.	YEAR	TYPE & REMARKS
		BCD 1964/5 2.4519.260.0 2.4519.270.0 FT-103	Same Deutz-Fahr Motore Industriale			

IN M12x1.5 OUT M12x1.5

FUEL PUMP

DEUTZ SERIES

DZ -1015		REFERENCE NO. OEM NUMBER	CAR & MODEL	ENG.	YEAR	TYPE & REMARKS
		BCD 2608 9.302.1.7140054 CR-028	KHD(Deutz) Motore Industriale(Spagna)			

IN M14x1.5 OUT M14x1.5

DZ -1016		REFERENCE NO. OEM NUMBER	CAR & MODEL	ENG.	YEAR	TYPE & REMARKS

IN M14x1.5 OUT M14x1.5

FUEL PUMP BEOGRAD IMT SERIES

BI-1001		REFERENCE NO. OEM NUMBER	CAR & MODEL	ENG.	YEAR	TYPE & REMARKS
		819.903	S77 S44			

IN M14x1.5 OUT M14x1.5

BI-1002		REFERENCE NO. OEM NUMBER	CAR & MODEL	ENG.	YEAR	TYPE & REMARKS
		801.495	S46			

IN M14x1.5 OUT M14x1.5

BI-1003		REFERENCE NO. OEM NUMBER	CAR & MODEL	ENG.	YEAR	TYPE & REMARKS
		BCD2514 122.00.00 SP145 801.653	BEOGRAD IPM Tr.IMT 533			

IN M14x1.5 OUT M14x1.5

BI-1004		REFERENCE NO. OEM NUMBER	CAR & MODEL	ENG.	YEAR	TYPE & REMARKS
		BCD2513 120.00.00 SP146 804.502	BEOGRAD IPM Tr.IMT 539			

IN M14x1.5 OUT M16x1.5



BI-1005		REFERENCE NO. OEM NUMBER	CAR & MODEL	ENG.	YEAR	TYPE & REMARKS
			CRANKSHFT IMT, SEAL RING			

FUEL PUMP

BEOGRAD IMT SERIES







	REFERENCE NO. OEM NUMBER	CAR & MODEL	ENG.	YEAR	TYPE & REMARKS
 BI-1006 IN M14x1.5 OUT M14x1.5	886373M91 5836010 2M86850 SF101	FUEL FILTER SINGLE MF,FORD			METAL BOWL
	1876507	FUEL FILTER HEAD MF 398			SINGLE METAL BOWL
 BI-1007 IN-OUT M14X1.5	7111-353AS 9918117 9927916	FUEL FILTER HEAD FIAT,IIVECO,...			SINGLE METAL BOWL
	17400300 7971072 13H3374 13H3375 25061494 25066393 461-170 461-171 7950300	4BMC LEYLAND LEYLAN NUFFIELD JCB	4/98 DN/NT TD 3.4 LITER V DIESEL 5.1 LITER 6/98 DIESEL 4/98 DIESEL V DIESEL 5.1,5,7 LITER DIESEL 3.8 LITER 6/98 DIESEL DT,NT 6/98 DIESEL DT,NT		
 BI-1008 IN-OUT 1/2"UNDX20	BCD2733 320/07040 320/07201	J.C.BAMFORD(JCB)	11.04-...	940	BHL 2CX,3CX,4CX,4CN G55Q,G63Q,G88Q LOADALL 506C 508C LOADALL 526,528
	17/402100 BCD2567 25061557 25061567 25066374 25066386 298006 2641709 2641713	2641A055 2641A071 3118234R91 3861 461-251 484072 60208 72095 910602	CARRARO CATERPILLAR CLARK COMMER CONSOL PNEUMATIC CONVEYANCER DODGE EICHER EPPLE BUXBAUM HESSTON JCB JCB JCB JCB JCB	TR,600,700 YC60C,660P DC70 COMMNDO SERIE 100 RG TC7 SERIES KC WALK THRU COMBINE 600 WINDROVER,6400,6650 LOADER 3C,3CX,3CX-4,3D LOADER 3DS,410,415,702,704 EXCAVATOR 110,180,805,806 LOADALL 520-2,520-4,525-2 LOADALL 525=4,525B,530-2	

FUEL PUMP J.C.B SERIES

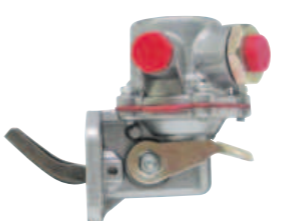
	REFERENCE NO. OEM NUMBER	CAR & MODEL	ENG.	YEAR	TYPE & REMARKS
 J-1001	BCD2733 320/07040 320/07201	J.C.BAMFORD(JCB)	11.04-...	940	BHL 2CX,3CX,4CX,4CN G55Q,G63Q,G88Q LOADALL 506C 508C LOADALL 526,528
	4132A016 4132A015 UPLPK0039 4226994M91 1R-0793	MASSEY FERGUSON CATERPILLAR			
 J-1002	4132A014 4132A018 4134M004 3679527M1 4226144M1 4226484M1 UPLPK0038 17/927800	MASSEY FERGUSON PERKINS JCB			MF 275,290,5425,5435 3CX,4CX
	32-925994 332/D6723	JCB CAT CASE			
 J-1003	17/402100 BCD2567 25061557 25061567 25066374 25066386 298006 2641709 2641713	2641A055 2641A071 3118234R91 3861 461-251 484072 60208 72095 910602	CARRARO CATERPILLAR CLARK COMMER CONSOL PNEUMATIC CONVEYANCER DODGE EICHER EPPLE BUXBAUM HESSTON JCB JCB JCB JCB	TR,600,700 YC60C,660P DC70 COMMNDO SERIE 100 RG TC7 SERIES KC WALK THRU COMBINE 600 WINDROVER,6400,6650 LOADER 3C,3CX,3CX-4,3D LOADER 3DS,410,415,702,704 EXCAVATOR 110,180,805,806 LOADALL 520-2,520-4,525-2 LOADALL 525=4,525B,530-2	perkins 4.236 perkins 4.236 perkins 4.236 perkins 4.236 perkins 4.236 perkins 4.236-236u/5670 perkins 4.236 perkins 4.212 perkins 4.236 perkins 4.248 perkins 4.236

FUEL PUMP

J.C.B SERIES

	REFERENCE NO. OEM NUMBER	CAR & MODEL	ENG.	YEAR	TYPE & REMARKS
 J-1004	17/913600 BCD2697 2641A057 2641A067 2641A082 AK-183 ULPK0034	4224451M91 FP664 17/913600	MASSEY FERGUSON PERKINS JCB JCB JCB	MF 6130 INDUSTRIAL 520,520S,520-55,520-55FS 520.520S,525-58,525-58FS 520LE,520SLE,520-50LE 520LE,520SLE,525-50S	Perkins 1004 4.40 Perkins 1004 4.40 Perkins 1004 4 Perkins 1004 4T Perkins 1004 42 Perkins 1004 40T
	17/912400 130506351 130506350 130506290	PERKINS	PERKINS 102		100 SERIES
 J-1005 IN Ø8 OUT Ø8	BCD 1942/1 25061593 25066397 2641719 2641720 2641729 2641A070 461-310 60251 907073	93151005 AK-150 FP310 PL-1009 ULPK0002 MF-399 17/402000	BEDFORD HYSTER J. C. B. LANCER BOSS LANDINI LAVERDA LEY LAND-ROVER MASSEY FERGUSON PERKINS		Perkins6.354.4 Perkins6.354.4 Perkins6.354.4 Perkins6.354.4 Perkins6.354.4 Beuvis Perkins6.354.4 Perkins6.354.4 Perkins6.354.4 Perkins6.354.4 Tr. Agr-ARM Industrial Dodge 100 Shovel Loader
	BCD 2697 2641A057 2641A067 2641A082 AK-183 U5LPK005 ULPK0034 4224451M91	4222106M91 FP664 17/408000	MASSEY FERGUSON PERKINS	MF 6130 Industrial	PERKINS 1004 4.40 PERKINS 1004 4.40
 J-1006	4132A016 4132A015 UPLPK0039 4226994M91 1R-0793	MASSEY FERGUSON CATERPILLAR			PF300C,CP323C, CS323C,PS360C,CS423E CP433E,CS433E,CB434D, CP533E,CS633E,CB534D COMPACTORS,M313C,M315C EXCAVATORS,TH210,TH215,TH220B, TH330B,TH340B,TH350B,TH355B, TH360B,TH460B,TH560B,TH580B
	4132A014 4132A018 4134M004 3679527M1 4226144M1 4226484M1 UPLPK0038 17/927800	MASSEY FERGUSON PERKINS JCB			MF 275,290,5425,5435 3CX,4CX
 J-1007	32-925994 332/D6723	JCB CAT CASE			
	17/927800				
 J-1008	17/927800				
 J-1009					
 J -1010					

FUEL PUMP

J.C.B SERIES

REFERENCE NO. OEM NUMBER	CAR & MODEL	ENG.	YEAR	TYPE & REMARKS
				

J -1011

FUEL PUMP KUBOTA SERIES

REFERENCE NO. OEM NUMBER	CAR & MODEL	ENG.	YEAR	TYPE & REMARKS
	KUBOTA	L35 L3240 L3300 L3400 L3430 L3600		

KB-1001

IN Ø8 OUT Ø8

REFERENCE NO. OEM NUMBER	CAR & MODEL	ENG.	YEAR	TYPE & REMARKS
	NORTHERN LIGHTS YANMAR	Yanmar 3TNE78A-ADCL Yanmar 4TNE84-ADCL Yanmar 4TNE88A-ADCL Yanmar 3TNE78-G1A,G2A,SA Yanmar 3TNE84-G1A,G2A,SA Yanmar 3TNE88-G1A,SA Yanmar 4TNE84-G1A,G2A,SA Yanmar 4TNE88-G1A,SA		Generator Set NL378 Generator Set NL484 Generator Set NL488 Motore Industriale Motore Industriale Motore Industriale Motore Industriale Motore Industriale

KB-1002

IN Ø8 OUT Ø8

REFERENCE NO. OEM NUMBER	CAR & MODEL	ENG.	YEAR	TYPE & REMARKS
	BENFRA J.C.BAMFORD(JCB) NORTHERN LIGHTS NUOVA ROCK PERKINS	perkins 103/10(3 cuk.)1.0 Lt perkins 103/10(3 cuk.)1.0 Lt Northern Lights 673 Northern Lights 753,753k Northern Lights 773LK,773LW2 Northern Lights 843,843N,843J Northern Lights 844 Northern Lights L844D(4 CIL)1.9LT perkins 103/10(3 cuk.)1.0 Lt perkins 103/10(3 cuk.)1.0 Lt		Miniescavatore 9.01B Miniescavatore 801 M673...,NL673... M753...,NL753... M773 M843...,NL843... M844...,NL844... M844...,NL844...,M20CR Motore marino Luggger Miniescavatore Rock 20 Motore Industriale

KB-1003

REFERENCE NO. OEM NUMBER	CAR & MODEL	ENG.	YEAR	TYPE & REMARKS
	KUBOTA STAYER	KUBOTA D950-B (3 CIL) KUBOTA V1100-B 4 CIL KUBOTA V1702-BC 4 CIL KUBOTA V1902-B 4 CIL KUBOTA V2203-B 4 CIL		Motore Industriale Motore Industriale Motore Industriale Motore Industriale Motore Industriale Troncatrice TF 84

KB-1004

REFERENCE NO. OEM NUMBER	CAR & MODEL	ENG.	YEAR	TYPE & REMARKS
	KUBOTA			Motore Industriale

KB-1005

FUEL PUMP

KUBOTA SERIES

REFERENCE NO. OEM NUMBER	CAR & MODEL	ENG.	YEAR	TYPE & REMARKS
	KUBOTA V1205 KUBOTA V1305 KUBOTA V1505			

KB -1006

REFERENCE NO. OEM NUMBER	CAR & MODEL	ENG.	YEAR	TYPE & REMARKS
	KUBOTA V3600			

KB -1007

REFERENCE NO. OEM NUMBER	CAR & MODEL	ENG.	YEAR	TYPE & REMARKS
				

KB -1008

REFERENCE NO. OEM NUMBER	CAR & MODEL	ENG.	YEAR	TYPE & REMARKS
	KUBOTA			16604-52032, 1G961-52030, 16285-52032, 15263-52030

KB-1009

FUEL PUMP CUMMINS SERIES

REFERENCE NO. OEM NUMBER	CAR & MODEL	ENG.	YEAR	TYPE & REMARKS
	CUMMINS,4B,4BT,6B,6BT			52001003 93151910 3918076 M73099 SP120 FP702

C-1001

REFERENCE NO. OEM NUMBER	CAR & MODEL	ENG.	YEAR	TYPE & REMARKS
	CUMMINS,6BT			screw thread 1/2"

C-1002

FUEL PUMP

CUMMINS SERIES

REFERENCE NO. OEM NUMBER	CAR & MODEL	ENG.	YEAR	TYPE & REMARKS
3917998 3936318 4988750	CUMMINS,6CT			screw thread 1/4"

REFERENCE NO. OEM NUMBER	CAR & MODEL	ENG.	YEAR	TYPE & REMARKS
2830266	Case-IH 580M,580SM,590SM(serie2) 750k(serie 2.3) JX1080U,JX1090U,JX1100U JX1085C,JX1095C	Consolidated Diesel 445/M2,445T/M2 4.5Lt Consolidated Diesel 445T/M2 4.5 Lt	02.04-... 01.06-... 01.04-... 10.05-...	
	Cummins Motore serie Case Family III	Consolidated Diesel 4,6cil .2V		
	Iveco Motore serie NEF	Consolidated 4,6cil .2V		
	Iveco Motore Marino	Iveco N45 MNA M10		
	Iveco Motore serie NEF	Iveco 4,6cil .2V(N45...N67M...)		

REFERENCE NO. OEM NUMBER	CAR & MODEL	ENG.	YEAR	TYPE & REMARKS
6TA590 4988769 3970881 3966155 3928144 3281838 3970880	CUMMINS	4BT		

REFERENCE NO. OEM NUMBER	CAR & MODEL	ENG.	YEAR	TYPE & REMARKS
3928144	Cummins	Motore Insustiale		

REFERENCE NO. OEM NUMBER	CAR & MODEL	ENG.	YEAR	TYPE & REMARKS
BCD 2660 3904374 3928143 610848 7971274 93151274 1904374 3966154	CUMMINS DAF INTERNATIONAL HARVESTER	Serie "B" Cummins5,9lit.Diesel cummins 6TA 590		Industial F1000CT Turbo Macch.lav. cotone 1822-2022

FUEL PUMP

FIAT&IVECO CNH SERIES

REFERENCE NO. OEM NUMBER	CAR & MODEL	ENG.	YEAR	TYPE & REMARKS
BCD 1947/5 115.16.070 4609596 4648022 4660069 4667509 4709282 4740717 4756678	4757886 FIAT-HITACHI FIAT-OM CARRELLI ELEVATORI IVECO FIAT 480 (FIAT GEOTECH) TRACTORU	D.8031.05.300 D.8031.05.200 D.8035.05.208/265/308/359 D.8035.06.240/309/340 D.8035.06.342/343 D.8041.05.200/201/204 D.8045.05.200 D.8045.05.200/201/204 D.8045.05.206/207/209		DL12,DL15,DL20,DL5 DL20C,DL25C,DL3C DL30CH,DL35C, DL40C,DL50 DL30,DL35,DL40 Tr.350,355,400 Tr.420,450,450DT Tr.455C,470,480DT Tr.500,500DT,505 Tr.505C,500DT

REFERENCE NO. OEM NUMBER	CAR & MODEL	ENG.	YEAR	TYPE & REMARKS
BCD 1948/5 4660068 4667510 4709283 4740718 4757882	FIAT-HITACHI FIAT-OM CARRELLI ELEVATORI FIAT-OM CARRELLI ELEVATORI FIAT-OM CARRELLI ELEVATORI	8035.01.265 3 cil. 4 cil. 2 cil.		Pala mec.FL4/D FL4/L,FL4/C DIM20,DIM25 DIM30,DIM35 DIM12,DIM15

REFERENCE NO. OEM NUMBER	CAR & MODEL	ENG.	YEAR	TYPE & REMARKS
BCD 2137/6 247109 25066442 4195148 4236973 4319577 4319578 4323062 4335817	4335818 4391515 4434830 4434833 4664133 5507940 5957869 5985119 701180	7552705 7579696 7617239 7689030 8605 9.06.035.11 9.06.217.11 POC 974 POC 083	1100,1300 1300 1300,1500 1100 1100,1300,1500 1116,1300 1300,1500 1116 1100	1/1988... 1988... 1983-1990 1981-1990 7/1990... 1991-1993 1988-1991

REFERENCE NO. OEM NUMBER	CAR & MODEL	ENG.	YEAR	TYPE & REMARKS
BCD 2146/5 25066446 3957754 4196041 4225568 4336342 4364431 4374853 4389400	4434789 4434834 4434840 4445630 461-4 461-5 5507933 8610 9.06.101.11	9.06.144.11 9.06.176.11 ABO-338 BC-123 POC 056 SEAT SEAT SEAT TOFAS OTO(Fiat Turchia) TOFAS OTO(Fiat Turchia)	1200 1400 1300,1600,t.t.Monoalbero 1200,1430 1430 1300,1600 1200,1400 1300,1430 1600 1300	7/66-1/72 1968-1974 ...3/1981 124 124 Special,Sport 131 124 D Pamplona 131 131 Mirafiori 124 131

REFERENCE NO. OEM NUMBER	CAR & MODEL	ENG.	YEAR	TYPE & REMARKS
BCD 2125/6 4286414 4338935 4434843 5507939 8611 9.06.072.11 POC 067	FIAT TOFAS OTO(Fiat Turchia)		1200 1200	2/1972 124 124

REFERENCE NO. OEM NUMBER	CAR & MODEL	ENG.	YEAR	TYPE & REMARKS
BCD2185/5 25066451 461-351 474659 7537698 7564923 7581031 7581032	7797698 7.21773.50 8604 8640 9.06.271.11 9.06308.11 PC-299 POC 113	FIAT FIAT FIAT FIAT FIAT	FIRE 1000 FIRE 750.1000 1000 1100 FIRE 1000 FIRE 1000,1100	1985-1991 - 1986... 1988-1991 - 1985-1990

REFERENCE NO. OEM NUMBER	CAR & MODEL	ENG.	YEAR	TYPE & REMARKS
BCD 2138/5 247100 2566443 4216142 4235618 42428522 4262334 4262553 4265958 4304630	4320185 4320330 4325618 4335865 4342565 4342566 4362269 4400568 4426211 4434832	5983935 701181 7564841 7.21753.50 9.06.214.11 AB-370 BC-107 POC 021 POC 027 POC 069	AUTOBIANCHI FIAT FIAT FIAT INNOCENTI SEAT SEAT SEAT YUGO YUGO	900 900,965 903 900 903 903 903 900

FUEL PUMP FIAT&IVECO SERIES

REFERENCE NO. OEM NUMBER	CAR & MODEL	ENG.	YEAR	TYPE & REMARKS
BCD1949/5 4673618 4709284 4740719 4757884 4802839 9.06.162.11 POC102 PON109	AIFO FIAT-HITACHI Tr.666,670,680,780,855 Autocarro40,50/8,40/35 FIAT-OM CARRELLI ELEVATORI Autocarro40/35AB,40A/B Autocarro50NC/A,50NC/B IVECO Industriale Veicol A90.14P,A70.14P	Industiale 1979 8055.25.200(5&6Cil) 8065.25.200Turbo diesel6 Cil.5&6Cil D.8041.05.260 D.8045.25.382 1979 1979 D.8055.05.200/205/250 D.8055.25.210 D.8060.05.245/246/270/271	1979 1979 1979 1979 1979 1979 1979 1979	8055.05.200,8065 8055.25.200(5&6Cil) 8065.25.200Turbo diesel6 Cil.5&6Cil D.8041.05.260 D.8045.25.382 D.8055.05.200/205/250 D.8055.25.210 D.8060.05.245/246/270/271

FUEL PUMP

FIAT&IVECO CNH SERIES

F-1009		REFERENCE NO. OEM NUMBER		CAR & MODEL	ENG.	YEAR	TYPE & REMARKS
		IN Ø8	OUT Ø8				
		BCD2110/5	4235510	FIAT	1100 T4,238E		PLASTIC
		00.039.363.08	4434837	FIAT	238 B,238B1		
		247140	POC 058		1200,1400		
		4160041	POC 090		1200,1400		
		4169041					
		4169058					
		4226658					
		4226821					

F-1010		REFERENCE NO. OEM NUMBER		CAR & MODEL	ENG.	YEAR	TYPE & REMARKS
		IN Ø8	OUT Ø8				
		BCD2110/5	4235510	FIAT	1100 T4,238E		
		00.039.363.08	4434837	FIAT	238 B,238B1		
		247140	POC 058		1200,1400		
		4160041	POC 090		1200,1400		
		4169041					
		4169058					
		4226658					
		4226821					

F-1011		REFERENCE NO. OEM NUMBER		CAR & MODEL	ENG.	YEAR	TYPE & REMARKS
		IN Ø8	OUT Ø8				
		BCD 2194/2	9.06.337.11	FIAT	1400,1600	1990-1992	Tempra(Carburatore)
		247147	BC-300	FIAT	1400,1600		Tipo,Tipo
		46618818	POC 121	FIAT	1370		DGT/AGT(Carbur.)
		711228	POC 605	YUGO	1372	1987...	Uno R89
		7611465		YUGO	1400,1600		Sana
		7611466					Florida
		7611466/5					
		7611475					
		8618					

F-1012		REFERENCE NO. OEM NUMBER		CAR & MODEL	ENG.	YEAR	TYPE & REMARKS
		IN Ø8	OUT Ø8				
		146137-15506924		R 12 BENZIN OTOMATIGI METAL			

F-1013		REFERENCE NO. OEM NUMBER		CAR & MODEL	ENG.	YEAR	TYPE & REMARKS
		IN Ø6	OUT Ø6 R Ø6				
		146137-15506924		R 12 BENZIN OTOMATIGI PLASTIC			

F-1014		REFERENCE NO. OEM NUMBER		CAR & MODEL	ENG.	YEAR	TYPE & REMARKS
		IN Ø8	OUT Ø8				
		1461-8315506956		R 9 Y.M BENZIN OTOMATIGI METAL			

F-1015		REFERENCE NO. OEM NUMBER		CAR & MODEL	ENG.	YEAR	TYPE & REMARKS
		IN Ø8	OUT Ø8				
		BCD 1946/5		ALFA ROMEO	Diesel 2000,2500	...6/1983	Furgone 30AR8,
		4279496		ALFA ROMEO	Diesel 2000	...6/1983	32AR8
		4724652		FIAT	Diesel 2000,2500	...6/1983	131
		4740996		FIAT	Diesel 2500	...6/1983	131 Marengo
		4749880		FIAT	Diesel 2500	...6/1983	132
		4755893		FIAT	Diesel 2500	...6/1983	Argenta
		9.06.136.11		FIAT	Diesel 2500	...6/1983	Campagnola
		FT-006		IVECO	Diesel 2500	...6/1983	Autocarro
		POC 097		IVECO	4 cil.8140.61.300 e der	...6/1983	Daily(Tutti tipi)
		PON 105		IVECO		...6/1983	Autocarro Grinta Industriale

FUEL PUMP

FIAT&IVECO CNH SERIES

F-1016		REFERENCE NO. OEM NUMBER		CAR & MODEL	ENG.	YEAR	TYPE & REMARKS
		IN Ø8	OUT Ø8				
		BCD 2132/6	9.06.111.11	FIAT	1300		X 1/9
		4252801	POC 072	FIAT	1500		X 1/9 USA
		4316006					
		4409727					
		4429209					
		4434838					
		7579488					
		7580846					
		8603					

F-1017		REFERENCE NO. OEM NUMBER		CAR & MODEL	ENG.	YEAR	TYPE & REMARKS
		IN Ø8	OUT Ø8				
		BCD 2149/5		FIAT	6132AZ62 Benzina		Campagnola Torpedo
		4379356					
		7564782					
		BC-244					

F-1018		REFERENCE NO. OEM NUMBER		CAR & MODEL	ENG.	YEAR	TYPE & REMARKS
		IN Ø8	OUT M Ø8				
		BCD 2151/5	4362741	9.06.040.11	FIAT	1500,1600	124 Special T. Spart
		00.039.577.55	4376770	9.06.044.11	FIAT	1800	124 USA Coupe-Spyder
		247141	4382283	9.06.108.11	FIAT	1600,1800	125
		25066447	4395751	AB-310	FIAT	1800	1977-1978
		4171616	4413008	AB-339	FIAT	1300 TC,1600 TD	131 Brava USA
		4226958	4434836	BC-1213	FIAT	1600,1800	131 Supemirafiori
		4235651	4434841	BC-239	FIAT	1600,1800	132
		4251447	4434842	GE 020.000.02	MORGAN	1600-Mat,DIAT 1585CC	1982-1985
		4266037	461-9	POC 032	SEAT	1600,1800	4x4
		4297956	5507934	POC 059	SEAT	1600	124,Sport
						1600,1800	131
							132

F-1019		REFERENCE NO. OEM NUMBER		CAR & MODEL	ENG.	YEAR	TYPE & REMARKS		
		IN Ø8	OUT Ø6						
		BCD 2173/5	4073564	4126886	7564842	FIAT	900	1982-199	1300,1500,1800,2300
		247146	4080389	4133166	8617	FIAT	900	...12/1975	Uno 45(Tutti i tipi)
		4045975	4080390	4139122	9.06.186.11	FIAT	1300,1500		Uno R89 Sting
		4048510	4080391	4434844	AB-340	FSO (FIAT Polonia)	1500		125 Kombi
		4048511	4081391	4447943	BC-296	FSO (FIAT Polonia)	1600		Polonez Alize,Amplia,Prima
		4055600	4087352	4447944	POC 077	FSO (FIAT Polonia)	1300		Polonez Mistral,Prima
		4055920	4091765	4447945	POC 111	FSO (FIAT Polonia)	1300		Polonez Prima
		4059510	4099844	5951864		YUGO			Furgone F.
		4065585	4119389	719386					
		4067110	4119952	735859					

F-1020		REFERENCE NO. OEM NUMBER		CAR & MODEL	ENG.	YEAR	TYPE & REMARKS
		IN Ø8	OUT Ø6.5				
		F3-33		FIAT			

F-1021		REFERENCE NO. OEM NUMBER		CAR & MODEL	ENG.	YEAR	TYPE & REMARKS
		IN Ø8	OUT Ø8				
		F3-62		FIAT 128			
		4195148		X19			
		4335818		RITMO			
		4391515		YUGO			
				REGATA			
				LANCIA			

F-1022		REFERENCE NO. OEM NUMBER		CAR & MODEL	ENG.	YEAR	TYPE & REMARKS
		IN Ø8	OUT Ø8				
		BCD2557		IVECO	IVECO 8144.21.222(ZONE FREDDA)		APPLICAZIONI VARIE
		4830098			IVECO D.8140.27.2100/21.202		MOTORE INDUSTRIALE
		8096163			IVECO D.8142.275.2800/2810/2819		MOTORE INDUSTRIALE
					IVECO D.8144.21.285/286		MOTORE INDUSTRIALE
							VEICOLO 15/49.10P
							VEICOLO 49.10 G,35.10P

FUEL PUMP

FIAT&IVECO CNH SERIES

REFERENCE NO. OEM NUMBER	CAR & MODEL	ENG.	YEAR	TYPE & REMARKS
BCD 2142/5	ALFA ROMEO	1750,2000 1.7-2.0LT		1750,2000 A11,A12
101.10.04.021.00		1.6-1.8-2.0LT	1988-1989	Alfa 75(tutti tipi)
105.00.04.020.00		1.6-2.0LT		ALFASPIDER
105.12.04.020.00		1.6-1.8-2.0LT	1976-1979	ALFETTA
105.44.04.020.00		1.6-1.8-2.0LT		F11,F12
25066445		1.3-1.6LT	1962-1976	Giulia Gt,Super
461-1		1.3LT	1980-1983	GIULIETTA
POC 065				

REFERENCE NO. OEM NUMBER	CAR & MODEL	ENG.	YEAR	TYPE & REMARKS
BCD 1921/6	VM MOTORI	VM MOTORI D 703 L-LT-LTS	...	2000 Motore industriale
1.518.0016A		VM MOTORI HR 288,HR 388H		Motore industriale
1.518.0016F		VM MOTORI HR 292,HR 392H		Motore industriale
1.518.0016G		VM MOTORI HR 394HP,HR 394HPT		Motore industriale
1.518.012				
1.518.016				

REFERENCE NO. OEM NUMBER	CAR & MODEL	ENG.	YEAR	TYPE & REMARKS
BCD 2170/5	FIAT	1365,1600 1.4-1.6LT	05.81-...	131 MIRAFIORI CL
4251051				
4445620				
4465880				
7564688				
9.06.177.11				
8 5008535				

REFERENCE NO. OEM NUMBER	CAR & MODEL	ENG.	YEAR	TYPE & REMARKS
4304051	FIAT TEMPRA			
7611466				

REFERENCE NO. OEM NUMBER	CAR & MODEL	ENG.	YEAR	TYPE & REMARKS
BCD 1947 /6	Alfo(Iveco)	Industriale	Iveco 8041.25.200	12.04-...
115.16.070	Case-IH	SH 150		11.02-...
4609596		JX45,56,75,85(s/n. 13286)		05.02-...
4648022		JX70U, JX80U, JX90U		
4660069		Tr.350,355,400		
4667509		Tr.420,450,450DT		
4709282		Tr.455C,470,480,480DT	Iveco 8035.02.202/204	
4740717		Tr.500,500DT,505	Iveco 8045.06.200	
4756678		Tr.505C,500DT Special		
4757883		Tr.540,550,550DT		
504090935	Fiat-Allis	Tr.555,580,600DT	Iveco 8045.25.380	
9.06.032.11	Fiat-Hitachi	Tr.600DT,3,605	3 cil	
9.06.161.11		Tr.605C,640,640DT	3 cil	
FP1947		Trattore	4 cil	
FT-001	Fiat-OM Carrelli	AD4, FL4, FL4/C, FL4/D	Iveco D.8031.05.300	
POC 098		Ldroyer TL5, FL5H, S60	Iveco D.8035.05.200	
PON 108		SH 150	Iveco D.8035.05.208/265/308/359	
		D12, D15, D120, D125	Iveco D.8035.06.240/309/340	
		D120C, D125C, D130C	Iveco D.8035.06.342/343	
		D130, D135, D140	Iveco D.8041.05.200/206/306	
		D130CH, D135C, D140C, D150	Iveco D.8045.05.200	
		Motore Industriale	Iveco D.8045.05.200/201/204	
		Motore Industriale	Iveco D.8045.05.206/207/209	
		Motore Industriale	Iveco D.8045.06.307/359/370/389	
		Motore Industriale	Iveco D.8045.06.206/320/322/346	
		Motore Industriale	Iveco D.8045.25.305/370/375	
		Motore Industriale	1.5 Lt	
	Tractorul Brasov	Trattore		

REFERENCE NO. OEM NUMBER	CAR & MODEL	ENG.	YEAR	TYPE & REMARKS
BCD 2134/5	FIAT	242,242 E,242 EFL		Benzina
4313588				
7564783				

FUEL PUMP

FIAT&IVECO CNH SERIES

REFERENCE NO. OEM NUMBER	CAR & MODEL	ENG.	YEAR	TYPE & REMARKS
BCD 2164/5	Autobianchi	A 112 Abarth	1050 cc 1.1 Lt/70 hp	1979-1984
247137		Y 10 Touring Turbo	1050 cc 1.0 Lt	1985-1988
25066483	Fiat	127 (Trutti I tipi)	1050 cc 1.0 Lt	1987-1990
4250477		Duna 60,70	1.1-1.3 Lt	1979-1988
4365252		Fiorino,pick-up	Fiat 1050 cc 1.0 Lt	
4427880		Ritmo 60 L	1050 cc 1.0 Lt	
4434835	Fiat(Argentina)	Duna	1.3-1.5 Lt	
4452648		Europa	1.3 Lt	
461-11		Regatta 85 weekend	1.1-1.3 Lt	
60338		Uno	1050 cc,1100,1500 1.0-1.1-1.5 Lt	
60339		147 Panorama,Pick-up	1050 cc 1.0 Lt	
7703714	Fiat(Brasile)	Elba,	1.3-1.6 Lt	
7718702		Pemio	1.3-1.6 Lt	
8606		UNO cs,r	1050 cc 1.0Lt	
9.06.141.11		Uno Mile	1.3 Lt	1987-1990
AB-601		Elba	1.3 Lt	
BC-118	Innocenti	Niva,Laika		
BC-238	Lada(Brasile)			
MS-60338-S				
POC 087				

REFERENCE NO. OEM NUMBER	CAR & MODEL	ENG.	YEAR	TYPE & REMARKS
BCD 2166/6	Fiat	124 Special T (Usa)	1.6 Lt	1974-...
247143	Lancia	Beta(Tutti I tipi)	1.3-1.4-1.6-1.8 Lt	
25066449		Beta Coupe	1.3-1.6-1.8 Lt	
4311132		Beta Coupe HPE	...385647-385581	
4333669		Beta HPE	1.6-1.8 Lt	
461-10		Beta Trevi	Mot. ...385581 1.6 Lt	
82285735				
82306704				
82313869				
82357923				
82378012				
8614				
9.06.146.11				
POC 070				

REFERENCE NO. OEM NUMBER	CAR & MODEL	ENG.	YEAR	TYPE & REMARKS
BCD 2169/5	8608	Regata 100 v.7056786-7380450	1600 TC 1.6 Lt	...-1984
00.039.362.74	9.06.192.11	Ritmo 100 S...vett.4880206	1.6 Lt	
247139	AB-598	Ritmo 105TC	1.6 Lt	
25066268	BC-115	Beta(Usa,Svezia)	2.0 Lt	1983-1986
3936274	POC 604	Delta GT	1600 TC 1.6 Lt	...-1984
3957756		Prismat	1.6 Lt	
4435013		Ronda Crono	1.6 Lt	
4463373				
461-388				
5936365				
7564245				
82353533				







REFERENCE NO. OEM NUMBER	CAR & MODEL	ENG.	YEAR	TYPE & REMARKS
BCD-2192	Fiat	1100T	217	1976-...
2101-1106010	FSO	125 P	1.3-1.6 Lt	...-03.93
4102819	Lada-Vaz	Niva 4x4 1.6(21217)	Lada-Vaz 2121-38 1.6 Lt	
4163954		Niva 4x4 1.7(21213,2131-0)	Lada-Vaz 21213 cab 1.7 Lt	
4384373		Niva 4x4 1.7(21216)	Lada-Vaz 21216 cab 1.7 Lt	...-01.01
7.21771.50		Zhiguli(2015),Nova,Junior	1.2-1.3-1.5 Lt	1973-1986
8520				
BC-236				
FT-004				
POC 112				

REFERENCE NO. OEM NUMBER	CAR & MODEL	ENG.	YEAR	TYPE & REMARKS
BCD-2197	FSO	125 P	1.3-1.5 Lt	...-1975
17504				
30090				
POC 612				

REFERENCE NO. OEM NUMBER	CAR & MODEL	ENG.	YEAR	TYPE & REMARKS
BCD 2198	FSO	Polonea Caro	1.5Lt	
39183				
41161				
61374				





FUEL PUMP

FIAT&IVECO CNH SERIES

REFERENCE NO. OEM NUMBER	CAR & MODEL	ENG.	YEAR	TYPE & REMARKS
 F -1035 IN M12x1.5 OUT M12x1.5	BCD 2517/5 7302703 8097132 PON 100 Fiat Iveco Lancia	Croma D,TD,SX Motore Industriale Motore Industriale Motore Industriale Motore Industriale Motore Industriale Motore Industriale Motore Industriale Motore Industriale Motore Industriale Motore Industriale Motore Industriale Thema,Thema SW	2.5 Lt Iveco D.8141.97R,2280 Iveco D.8144.91.2000/2001 Iveco D.8144.91.2002/2009 Iveco D.8144.91.2090/2280 Iveco D.8144.97.1200/1201 Iveco D.8144.97.1209/1210/1219 Iveco D.8144.97.2200/2201 Iveco D.8144.97.2209/2210/2220 Iveco D.8144.97.2229/2249/2280 Turbodiesel 2.5 Lt	
 F -1036 IN M12x1.5 OUT M12x1.5	BCD 2518/5 4800420 4802838 FT-002/1 Iveco	65.9 Motore Industriale Motore Industriale Motore Industriale Motore Industriale Motore Industriale Motore Industriale Motore Industriale Motore Industriale Motore Industriale Motore Industriale Veicolo 65.12,79.12,79.14	Iveco 8040.5 Iveco D.8040.05.200,8040.25.200 Iveco D.8040.05.200/203/233/290 Iveco D.8040.25.200/201/202 Iveco D.8040.25.203/207/208 Iveco D.8040.25.221/222/224/225 Iveco D.8040.25R.230/231/233/234 Iveco D.8060.05.200,e var Iveco D.8060.05.248/260/266 Iveco D.8060.05.280/284/289 Iveco D.8060.05R.206	
 F-1037 IN 1/2"-20 UNF OUT 1/2"-20 UNF	BCD 2523 25061571 25066391 394-11131 461-313 7990315 Dorman	Motore "L"Range		
 F-1038 IN M10x1.0 OUT M10x1.0	BCD 2613 652,36 Ruggerini	Motore Industriale	Ruggerini MD 75,MD 95	
 F -1039 IN M12x1.5 OUT M12x1.5	BCD 2621 98419724 FT-002/2 Fiat Iveco	F 120 Motore Industriale Motore Industriale	Iveco D.8065.05.225/230/325/330 Iveco D.8065.06.230/330	
 F -1040 IN M14x1.5 OUT M14x1.5	BCD 2647 1.518.2007F VM Motori	Motore Industriale	VM Motori 2.3.4 CIL.c/reg,elettron.	
 F -1041 IN M12x1.25 OUT M12x1.25	BCD 2648 8284989 Balkancar	Carrelli elevatori		

FUEL PUMP

FIAT&IVECO CNH SERIES

REFERENCE NO. OEM NUMBER	CAR & MODEL	ENG.	YEAR	TYPE & REMARKS
 F -1042 IN M10x1.0 OUT M10x1.0	BCD 2652 115.6585.076.8 Lombardini	Motore Industriale	Lombardini LDW 1204	1992-1997
 F-1043 IN M14x1.5 OUT M14x1.5	BCD 2666 50332300,87 PX-701 Hatz	Motore Industriale	Hatz Z 788	
 F-1044 IN M10x1.0 OUT M10x1.0	BCD 2690 Dorman	Applicazioni varie		
 F-1045 IN M14x1.5 OUT M14x1.5	BCD 2719 7.21537.00 Hanomag	Industriale		
 F-1046 IN 1/2"-20 UNF OUT 1/2"-20 UNF	BCD 2734 836667405 Sisu Diesel	Industriale		

FUEL PUMP FORD(EURO) SERIES

REFERENCE NO. OEM NUMBER	CAR & MODEL	ENG.	YEAR	TYPE & REMARKS
 FD-1001 IN Ø8 OUT Ø8	BCD 2658/2 25062638 6 201 102 7 133 976 904F9350 AB 914F9350 AA 93151848 SP117 FORD(EU) Transit	FSD 425 2.5LT .TURBODIESEL		

FUEL PUMP

FORD(EURO) SERIES

REFERENCE NO. OEM NUMBER	CAR & MODEL	ENG.	YEAR	TYPE & REMARKS
BCD 2658/2 25062638 6 201 102 7 133 976 904F9350 AB 914F9350 AA 93151848 SP117	FORD(EU) Transit	FSD 425 2.5LT .TURBODIESEL		STEEL

REFERENCE NO. OEM NUMBER	CAR & MODEL	ENG.	YEAR	TYPE & REMARKS
2066609 6 551 959 8622 91SF9350 AB	FORD(EUROPA) FORD(EUROPA) FORD(EUROPA)	CVH 1400,1600	1991...	Escort Fiesta CVH Orion CVH

REFERENCE NO. OEM NUMBER	CAR & MODEL	ENG.	YEAR	TYPE & REMARKS	
0 800 432 1 475 240 1 535 498 11 448 047 247091 461-23 461-281 6 005 467 6 038 859 6 146 182	69EN9350 AA 69EN9350 BA 70HF9350 CA 72TF9350 BA 74TF9350 BB 74TF9350 AA 76TF9350 AA	FORD(EUROPA) FORD(EUROPA) FORD(EUROPA) FORD(EUROPA) FORD(EUROPA) FORD(EUROPA) FORD(EUROPA)	1800,200,2300(6V) 2300(108/125 PS) 200,2300(6V) 2300,2600,2800,3000(6V) 2300,3000(6V) 200,2800(6V) 2300,2600,3000(6V) 200,2300(6V) 1500,1700(4V-60/65 PS) 2800(6V)	9/67-1971 9/68-3/70 3/69-8/79 3/1969... 4/70-7/75 8/1975... 4/70-7/75 10/1982... 4/70-8/82 4/73-7/84 4/73-1/74	17 M,20 M,26M 20 M,26 M Copri II Copri II Consul Granada Granada Sierra Taurus Transit Capri

REFERENCE NO. OEM NUMBER	CAR & MODEL	ENG.	YEAR	TYPE & REMARKS
BCD 2576 25061519 25066390 394-11130 461-160 7950636 7971021 AE-060	AE-060/1 AE-060/2 E1ADDN9350 FP160 SM-9350	ALBION BORMAN FORD(EUROPA) LEYLAND-ROVER	leyland 4000 4DA,6DA,6DA-V12 1613502... 400	1962... 1965... Major,Super Major Albion-Reiver CD-21

REFERENCE NO. OEM NUMBER	CAR & MODEL	ENG.	YEAR	TYPE & REMARKS
BCD1533/2A 12A1259 25061526 25066383 2641469 461-179 510E9350 7950618 7971029	7971183 831149 831149A A500360 A502983 AE-059 AE-059/1 D33858 D9NN9350 B	AE-058/2 FP314A ST-4A9350 CAV FORD(EUROPA) LEYLAND-ROVER TAQLBOT	1967-1973 1967-1968 ...1/1974 1/1974 1962-1966	Leyland 470 Simms P4/6731 Diesel 370,400 Diesel 400 Leyland OE370/400 V8,511&511 4cil.P4632/33/79/85/86 6 cil.p4594/4635/36/64/87

REFERENCE NO. OEM NUMBER	CAR & MODEL	ENG.	YEAR	TYPE & REMARKS
BCD 1686 25061578 25066381 461-276 683F9350 AA 683F9350 AB 683F9355 AA 683F9355AB 7971160	7990361 A0-047 A0-047/1 FP276 FORD(EUROPA) FORD(EUROPA) FORD(EUROPA) FORD(EUROPA) FORD(EUROPA) FORD(EUROPA)	COLES CRANES FORD FORD FORD(EUROPA) FORD(EUROPA) FORD(EUROPA) FORD(EUROPA) FORD(EUROPA)	Ford 2713E D/N Diesel 4200,6000,6200 D/NDies.DA10,DA21,DT17/20 2700 Serie 254,380 6cil.135 HP 4,2-6,0-6,0 Turbodiesel 6,2 Diesel Diesel	1973 Industriale Industriale 1965-1980 1973-1980 1965... 1965... D Serie D-K R Serie 360 & 380

REFERENCE NO. OEM NUMBER	CAR & MODEL	ENG.	YEAR	TYPE & REMARKS
BCD 1796 25061539 25061543 25061570 25061610 25066387 25066389 2641473 2641476	2641479 7990313 AK-101 FP220 FP330 ULPK0013 D8NN9350AA 508995/2 7971392 7971405	BERLIET DENNIS FORD(EUROPA) HAULAMATIC LEYLAND-ROVER PERKINS SEDDON ATKINSON TALBOT	Perkins V8.510 Perkins V8.540 Perkins V8.510,540 V8.510,V8540,P710 1974... 1965-1968 1974...	Bus City Pr100 F108 Fire Truck D 100 Serie D Phase II Dump Truck 6/15 Boxer BX 1425 Mastiff & Super Mastiff Industriale

FUEL PUMP

FORD(EURO) SERIES

REFERENCE NO. OEM NUMBER	CAR & MODEL	ENG.	YEAR	TYPE & REMARKS
93151351 SP061 966T9350AA	FORD CARGO	DOVER DIESEL		

REFERENCE NO. OEM NUMBER	CAR & MODEL	ENG.	YEAR	TYPE & REMARKS
957E9189C 66895	FORD Fordson Dexta	Perkins		

REFERENCE NO. OEM NUMBER	CAR & MODEL	ENG.	YEAR	TYPE & REMARKS
BCD 1774/5 461-233 715F-9350-AA 7990020 A505117/2 PON 117	Lucas-CAV,Delphi Ford(EU) Industriale Transit Furgone	Ford Ford Transit 6 cil.Diesel		...-05.72 1972-...

REFERENCE NO. OEM NUMBER	CAR & MODEL	ENG.	YEAR	TYPE & REMARKS
BCD 1855/7 25061522 25066376 25066377 2641308 461-109 461-169 502E9350 7950065 7950188	7950426 Dale Electric Ford Generatore elettrico Industriale Industriale Industriale Trattore Hunslet Hydrovane Lansing Bagnall Massey Ferguson Perkins Towmotor	Perkins D3.152 4 cil.(Simms p4145/78) 4 cil. p4250/51,p4354 6 cil.(Simms p4316,p4354) Perkins D3.152 Perkins D3.152 Perkins D3.152 Tr.122 Motore Industriale 560P FLT	1968-...	

REFERENCE NO. OEM NUMBER	CAR & MODEL	ENG.	YEAR	TYPE & REMARKS
BCD 1886/5 25061581 25066406 461-279 509943 1755F-9350-AA 7990395 A506401/2 FP279 PON 102	Ford(EU) A Serie York (no zone freedde) Transit (no zone freedde)	Diesel Diesel 2.4 Lt		1973-1983 1972-...

REFERENCE NO. OEM NUMBER	CAR & MODEL	ENG.	YEAR	TYPE & REMARKS
BCD 1896/5 1 474 926 1 475 926 109E-9350-BA 247090 25061532 25061617 2735E-9350-CA 2737E-9350-A 3620 3626 461-128 461-187 461-194 461-197 461-285 461-335 6 132 168 6 160 896 691F-9350-AB 7.20933.50 7950695 7971241 7971263 7971280 7971463	Ford(EU) 5/7 CWT 6/8 CWT Anglia Capri,Capri GT Cortina Cortina(MK2-3-4) Cortina Lotus Escort Escort,Escort GT Fiesta Fiesta XR2,OHV Kent marino,105E Lotus Transit(UK) Elan 1558,Cortina Seven,Super Seven Morgan 4x4 III-IV-V	Anglia Escor 1.3-1.6 Lt 1.2-1.3-1.5-1.6 Lt 1.3-1.6Lt 1558 cc 1.6 Lt 0.95-1.1-1.3 Lt 1.1-1.3 Lt 0.95-1.1-1.3 Lt 1.6 Lt Kent(4 cil.) Benzina 1.6 Lt 105,109 E Ford L34	1965-1967 1968-... 1965-1970 1967-... 1965-1974 05.70-1976 1975-1980 1968-1975 07.76-08.88 1981-1983 1961-... 1968-1978 1975-... 1967-1973 1963-... 1965-...	

FUEL PUMP

FORD(EURO) SERIES

REFERENCE NO. OEM NUMBER	CAR & MODEL	ENG.	YEAR	TYPE & REMARKS
BCD 1533/2A 831149A	AEC Guy	Comet	Leyland 470(Simms P46731)	1965-1970
12A1259 A500360	Bedford Tk	EA	370,400 Diesel	01.74-...
25061526 A502983	VA Autotelaio Industriale	Motor industriale	400 Diesel	1967-1973
25066383 AE-059	C.A.V.(Lucas-CAV ,Delphi)	Motor industriale	Leyland OE 370,400	...-01.74
2641469 AE-059/1	Dodge/Commer D407 7-8 Ton	Motor industriale	V8.511&511	1967-1968
461-179 AE-059/2	3000,5000,8000,9000	Motor industriale	P4594/4635/36/64/87 6 CIL	1962-1966
510E-9350 D33858	Chrysler Europe Ford(EU)	Motor industriale	P4632/33/79/85/ 4 CIL	5000
7950618 D9NN-9350-B	Industriale(Simms)	Leyland E370/400(4-6 CIL)Diesel	370(Simms P4606/1)	
7971029 FP314A	Industriale(Simms)	super Dexta Super Major	Horizontal(Simms P4614)	
7971183 ST-4A9350	Leyland Albion k & M		370(Simms P4606/21/57)	1986-...
831149				

FD-1015 IN 1/2"-20 OUT 1/2"-20

FUEL PUMP OPEL SERIES

REFERENCE NO. OEM NUMBER	CAR & MODEL	ENG.	YEAR	TYPE & REMARKS
BCD 2657/1	5506975 816070	OPEL	1600,1800	1982... Camira JB,JD
247095	60368 816075	OPEL(Brasile)	1300	1981... Ascona C,S
25061468	60369 8442		1200	9/1988... Corsa NB,S,SB
25061477	7.20971.53 93151803		1600	1982... Corsa S,ST
25066275	7.20971.54 94658977		1400	1989-1991 Kadett
3441	7.20971.57 9.06.339.11		1300	9/1988... Kadett E
3442	7.20971.59 BC-148		1200	8/86-1988 Kadett N,NB,S
461-84	7.20971.63 FPM-037		1600	1978-1982
461-85	816059 MS-60368-S			
52257318	816068 POX 526			
5506961	816069 PX-802 PX-803			

O-1001 IN Ø8 OUT Ø6.5

REFERENCE NO. OEM NUMBER	CAR & MODEL	ENG.	YEAR	TYPE & REMARKS
BCD 1937/7	7.15612.50 8446	OPEL	1100	9/65-12/75 Admiral
2406	7.20971.50 94642703	OPEL	1200	1983... Ascona
25061467	7.20971.56 9.06.340.11	OPEL	1300...Mot.348040	1979... Ascona
461-22	7.20972.50 PX-805	OPEL	1900	1965-12/75 Blitz
461-58	816019	OPEL	1200,1300...Mot.348040	1979-1984 Blitz
461-69	816023	OPEL	1500	9/67-8/70 Kadett S,OHC
5506960	816025	OPEL	1700	9/67-8/80 Kadett,Olympia
6780	816034	OPEL	1900	9/65-12/75 Kapitän
6783	816049	OPEL	1900	1979... Manta
7.15515.50	816050	OPEL	1500,1700	Rekord

O-1002 IN Ø8 OUT Ø6.5

REFERENCE NO. OEM NUMBER	CAR & MODEL	ENG.	YEAR	TYPE & REMARKS
GFP857				

O-1003

REFERENCE NO. OEM NUMBER	CAR & MODEL	ENG.	YEAR	TYPE & REMARKS
GFP1015				

O-1004

REFERENCE NO. OEM NUMBER	CAR & MODEL	ENG.	YEAR	TYPE & REMARKS
GFP863				

O-1005 IN Ø8 OUT Ø8 RØ6

FUEL PUMP

OPEL SERIES

REFERENCE NO. OEM NUMBER	CAR & MODEL	ENG.	YEAR	TYPE & REMARKS
GFP1008				

O-1006

REFERENCE NO. OEM NUMBER	CAR & MODEL	ENG.	YEAR	TYPE & REMARKS
BCD 1516/5	8.160.21	AUDI F 103	1.7L/53 kw(72 ps)	
247089	8.160.39	OPEL Ascona,Manta	1.2 Lt	
25061457	8.169.42	Kadett	994,1078,1200 cc1.0-1.1-1.2 Lt	
3444	8444	Olympia	1.1-1.2 Lt	
461-49	POC 522			
5506900				
5506942				
7.15047.50				
7.20934.50				
8.160.13				

O-1007 IN Dia.6 OUT Dia.6

REFERENCE NO. OEM NUMBER	CAR & MODEL	ENG.	YEAR	TYPE & REMARKS
BCD 1637/5	OPEL Admiral 2600			Opel 2473 cc 2.5L/75 Hp 1962-1965
7.15299.50	Kapitan 2500			Opel 2605 cc 2.6Lt 1956-1962
8.160.12	Kapitan 2600			Opel 1488 cc 1.5Lt/45 Hp 1962-1965
8.932.026	Olympia,Rekord 1500			1956-1962
APG PE 14604	Rekord AB 2600			1962-1965
APG PE 15299				

O -1008 IN M10x1.0 OUT10x1.0 c/kit tubetti d.6/8

REFERENCE NO. OEM NUMBER	CAR & MODEL	ENG.	YEAR	TYPE & REMARKS
BCD 1938/7	Holden Torana 1900 lh/x,Sunbird			Opel 1892 cc 1.9 Lt 1974-1978
247088	Admiral B			H/S 2.8 Lt 1969-07.77
25061450	Ascona A,B,N,S			1.6-1.9-2.0 Lt 08.70-09.81
3443	Blitz LKW			Opel 2473 cc 2.5 Lt 1966-...
461-38	Commodore			2200,2500,2800 1967-1977
461-41	Diplomat B			H/S2.2-2.5-2.8 Lt 1969-07.77
461-57	Kadett B,Olympia A			H/S 2.8 Lt 08.65-03.71
5506901	Kadett S,GT			Opel 1897 cc 1.9 Lt 1969-08.79
5506925	Kapitan 2800			1.6-1.9 Lt 1969-07.77
5506932	Manta B 1.6N/S-1.9 S-2.0N/S			2784 cc 2.8 Lt 08.70-09.81
5506954	Monza			1.6-1.9-2.0 Lt 10.67-08.82
7.15503.50	Monza			2784 cc 2.8 Lt 1978-...
7.15556.50	Monza			2800 H 2.8 Lt 1978-...
7.20971.52	Rekord			3000H 03.71-...
8.160.30	Rekord			1.7-1.9-2.0 Lt 1967-1968
8.160.31	Rekord			2.2 Lt 10.67-08.82
8.160.35	Pontiac Senator			2784 cc 2.8 Lt 1978-...
8.160.36	Ranger Senator			2800 H 2.8 Lt 1978-...
8.160.47	Vauxhall Senator			3000H 1978-...
8.930.335	Le Mans (DAEWOO)			Opel 1900 1.9 Lt 1974-1978
816036	S,SH			1.7-1.9-2.5-2.8 Lt 1972-08.77
8443	Carlton S,Viceroy			2.0-2.5 Lt 09.78-1982
90534412	Cavaliere S			1.6-1.9-2.0 Lt 1975-1981
90534432	Royale			2.8 Lt 10.78-1983
BC-149	Senator			1984-...
FPM-036				
G 6932				
GFP 4271N				
POC 307				
PX-800				
PX-804				











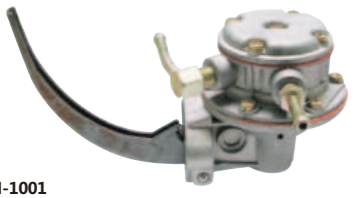

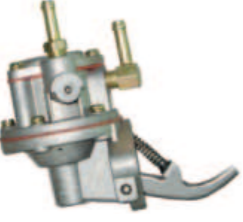



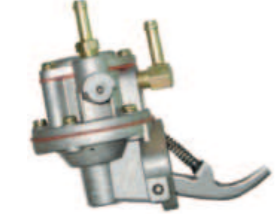



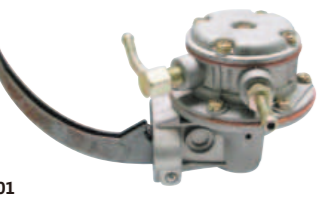
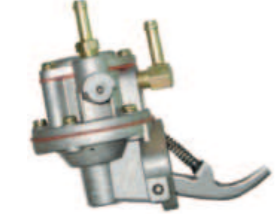



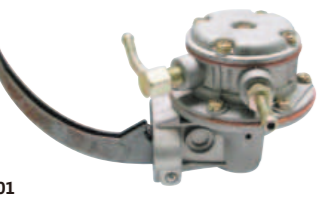
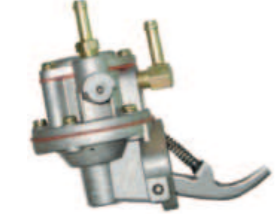



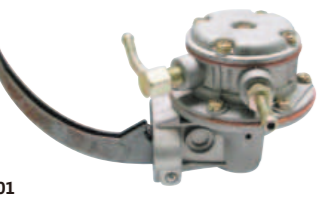
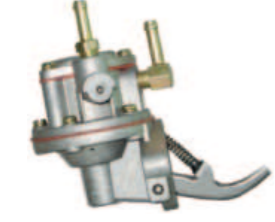

O -1009 IN Dia.8 OUT Dia.6

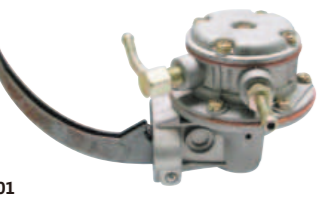
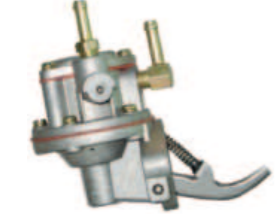
REFERENCE NO. OEM NUMBER	CAR & MODEL	ENG.	YEAR	TYPE & REMARKS
BCD 1996/5	9.06.341.11 Opel Corsa ST,N,S			1.0 -1.2 Lt 1983-...
2404	BC-151 Kadett			Mot.170259...1.0-1.2 Lt 09.82-...
247119	POC-310 Vauxhall Astra			1.2 Lt 1981-...
25061476	PX-801 Nova			1.1 Lt 1983-...
461-79				
5506966				
5506974				
7.20934.52				
8.160.57				
8.160.61				
8445				

O-1010 IN Dia.6 OUT Dia.6

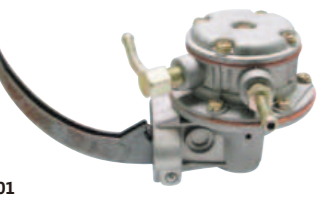
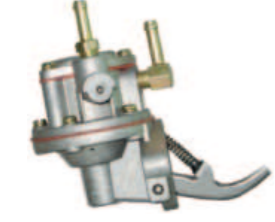











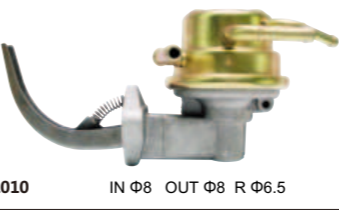

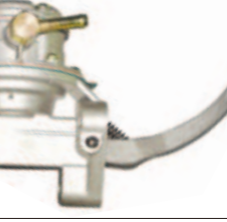

FUEL PUMP

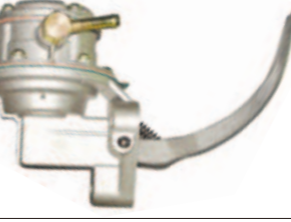
NISSAN SERIES

Image	REFERENCE NO. OEM NUMBER		CAR & MODEL	ENG.	YEAR	TYPE & REMARKS
	NP587		NISSAN BLUEBIRD DATSUN TRUCK DATSUN TRUCK(USA) DATSUN 620 PICK UP USA NISSAN 1600/1800J SERIES STANZA 180B200B	810B	77-82	B/S:41652 FP60113
	DW 202			L20B	75	
	17010-U9625/6	-W5725	SUNNY(EXP) PLUSA SENTRA(USA)	E15	84-	STEEL 3P
	-U9625/6	-B9800		E16		
	17010-34A25		SUNNY(EXP)(USA)	120Y/B110	70-	FP60102
	17010-36A25			B120/1200cc B120A12		
	17010-H1900/6		SUNNY(EXP)	B210	74-	FP60107
	BCD2535/6			B110 A12 120Y		
	NP403		SUNNY(EXP)	B210	74-	FP60107
	DW223			B110 A12 120Y		
	17010-J1925/6		SUNNY(EXP)(USA)	B210	74-	FP60107
	17010-H1900/6			B110 A12 120Y		
	BCD2535/6		SUNNY(EXP)	B210	74-	FP60107
				B110 A12 120Y		
	NP403-1		SUNNY(EXP)	B210	74-	FP60107
	DW224			B110 A12 120Y		
	17010-H5325/6-7		SUNNY(EXP)	B210	74-	FP60107
	17010-H5302-4			B110 A12 120Y		
	17010-H5300		SUNNY(EXP)	B210	74-	FP60107
	BCD2510/6			B110 A12 120Y		
	NP 593		SUNNY(EXP)	B210	74-	FP60107
	DW226			B110 A12 120Y		
	17010-M9025		SUNNY(EXP)	B210	74-	FP60107
	17010-M9000			B110 A12 120Y		
	NP 808		SUNNY(EXP)	B210	74-	FP60107
	DW278			B110 A12 120Y		
	17010-06E25		SUNNY(EXP)	B210	74-	FP60107
	17010-06E00			B110 A12 120Y		
	NP 504		SUNNY(EXP)	B210	74-	FP60107
	DW229			B110 A12 120Y		
	17010-E3012-3		SUNNY(EXP)	B210	74-	FP60107
	17010-Y0126-7			B110 A12 120Y		
	NP 808		SUNNY(EXP)	B210	74-	FP60107
	DW278			B110 A12 120Y		
	17010-06E25		SUNNY(EXP)	B210	74-	FP60107
	17010-06E00			B110 A12 120Y		
	NP 504		SUNNY(EXP)	B210	74-	FP60107
	DW229			B110 A12 120Y		
	17010-E3012-3		SUNNY(EXP)	B210	74-	FP60107
	17010-Y0126-7			B110 A12 120Y		
	NP 593		SUNNY(EXP)	B210	74-	FP60107
	DW226			B110 A12 120Y		
	17010-M9025		SUNNY(EXP)	B210	74-	FP60107
	17010-M9000			B110 A12 120Y		
	NP 808		SUNNY(EXP)	B210	74-	FP60107
	DW278			B110 A12 120Y		
	17010-06E25		SUNNY(EXP)	B210	74-	FP60107
	17010-06E00			B110 A12 120Y		
	NP 504		SUNNY(EXP)	B210	74-	FP60107
	DW229			B110 A12 120Y		
	17010-E3012-3		SUNNY(EXP)	B210	74-	FP60107
	17010-Y0126-7			B110 A12 120Y		
	NP 808		SUNNY(EXP)	B210	74-	FP60107
	DW278			B110 A12 120Y		
	17010-06E25		SUNNY(EXP)	B210	74-	FP60107
	17010-06E00			B110 A12 120Y		
	NP 504		SUNNY(EXP)	B210	74-	FP60107
	DW229			B110 A12 120Y		
	17010-E3012-3		SUNNY(EXP)	B210	74-	FP60107
	17010-Y0126-7			B110 A12 120Y		
	NP 593		SUNNY(EXP)	B210	74-	FP60107
	DW226			B110 A12 120Y		
	17010-M9025		SUNNY(EXP)	B210	74-	FP60107
	17010-M9000			B110 A12 120Y		
	NP 808		SUNNY(EXP)	B210	74-	FP60107
	DW278			B110 A12 120Y		
	17010-06E25		SUNNY(EXP)	B210	74-	FP60107
	17010-06E00			B110 A12 120Y		
	NP 504		SUNNY(EXP)	B210	74-	FP60107
	DW229			B110 A12 120Y		
	17010-E3012-3		SUNNY(EXP)	B210	74-	FP60107
	17010-Y0126-7			B110 A12 120Y		



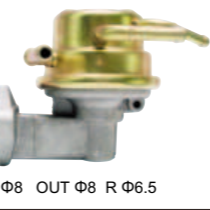



FUEL PUMP

NISSAN SERIES

Image	REFERENCE NO. OEM NUMBER		CAR & MODEL	ENG.	YEAR	TYPE & REMARKS
	TD 714		PULSAR.SUNNY(EX) PULSAR SENTRA(USA)	E13	81-	STEEL
	DW214			E15 E-15S 1600/2000cc		
	17010-23M25-6		NISSAN SENTRA	GA16DS	92	STEEL
	17010-01M25-6					
	17010-11M25-6		NISSAN SENTRA	GA16DS	92	STEEL
	17010-11M00/1					
	BCD2687		NISSAN SENTRA	GA16DS	92	STEEL
	NP 844		NISSAN SENTRA	GA16DS	92	STEEL
	17010-53Y25					
	NP 779		DATSUN TRUCK PICK-UP(720)	Z20	84-	STEEL
	NP850-9					
	17010-06W15		DATSUN TRUCK PICK-UP(720)	Z20	84-	STEEL
	DW232-1					
	17010-06W 25-28		DATSUN TRUCK PICK-UP(720)	Z20	84-	STEEL
	NP 714		NISSAN	1600/2000cc CA16,CA18,C	85-	STEEL
	NP504		CEDRIC(USA) SKYLINE(T230)(K230)	L20	73-	STEEL 2P
	DW229					
	17010-E3012-3		CEDRIC(USA) SKYLINE(T230)(K230)	L20	73-	STEEL 2P
	17010-Y0126-7			230 260C		
	NP622		DATSUN TRUCK	J16	79-	STEEL
	DW 204					
	17010-01W00/2		DATSUN TRUCK	J16	79-	STEEL
	17010-01W25-7			1600cc J15		
	NP625		DATSUN TRUCK DATSUN TRUCK (COOLER CAR) DATSUN TRUCK (COOLER CAR)(EXP) DATSUN TRUCK (MIDDLE NEAREAST) (TORRID ZONE)	1600cc	79-81	STEEL
	DW272			J15,J16		
	17010-T5070/72		DATSUN TRUCK DATSUN TRUCK (COOLER CAR) DATSUN TRUCK (COOLER CAR)(EXP) DATSUN TRUCK (MIDDLE NEAREAST) (TORRID ZONE)	1600cc	79-81	STEEL
	17010-01W25-7			J15,J16		
	17010-01W00/02		DATSUN TRUCK DATSUN TRUCK (COOLER CAR) DATSUN TRUCK (COOLER CAR)(EXP) DATSUN TRUCK (MIDDLE NEAREAST) (TORRID ZONE)	1600cc	79-81	STEEL
	17010-01W85			J15,J16		
	17010-01W10		DATSUN TRUCK DATSUN TRUCK (COOLER CAR) DATSUN TRUCK (COOLER CAR)(EXP) DATSUN TRUCK (MIDDLE NEAREAST) (TORRID ZONE)	1600cc	79-81	STEEL
	17010-03W25-6			J15,J16		

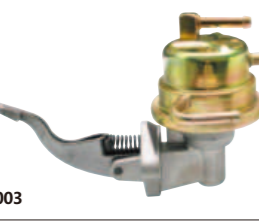

FUEL PUMP

MITSUBISHI SERIES



MI-1001	REFERENCE NO. OEM NUMBER	CAR & MODEL	ENG.	YEAR	TYPE & REMARKS
	MP 791/MP571 DW 005 DW599-2 MD 034060/2 MD 034065/6 (MP790) (A9104) MD 997697/ MD 997510/1	LANCER ARROWCOLT	4G3	81-86	STEEL OIL PUMP
		GALANT L300 SAPPORO, VISTA SG, SD, SECHAL PMGER 1600cc DODGE GALANT MITSUBISHI YD	A161	(3 PIPE)	BODY MD 009044 FP62102 B/S:5021
	MP792 DW 006 MD 997697/ MD008931 (A9102) MD034533	CHALLENGER 1600cc SIGMA (SATURN MOTOR) L200 LANCER, GALANT 1600cc ARROW COLT, SAPPORO, VISTA	4G3	77-80 (2 PIPE)	STEEL TYPE 2 PIPE B/S:41596
	MP 704 DW013 MD088066 MD181496 1516772 MD138587	JEEP RAJERO (EXP) USA USA DGD GECOLT 200-2800CC	2000- 2800cc G52B G54B G52B G54B	84- 84-	STEEL B/S:41487 STEEL (MP 642 SIM)
	MP772 DW018 MD068821(A9114) MD 997509/699769 MD 175179 MD 997675 MD 997695	mitsubishi L300 MIRAGE LANCER EX 1300-1500cc	4G62 4G1	85-	FPM 056 STEEL 4 PIPE FP62111
	MP768/GP706 DW 002 31700-21020 31700-21200 MD041280 MD997508 MD997694(A9105)	MITSUBISHI-CORDIA, NIRAGE TRIDA, PICK UP LANCER EX DODGE COLT, PLY (USA) PRT. SAGA, (MALAYSIA) PONY EXCEL (EXP) 1500-2000cc	4G1 4G6	83-84	STEEL
	MD 068821K (A9114) MD 997509/699769 MP769 MD997693/030830	MITSUBISHI L300 MIRAGE LANCER EX 1300-1500cc LANCER	4G62 4G1	85-	
	MP789 MD 034358 MD 177033 DW005-1	GALANT L300 LANCER	4G3	67-89 (4 PIPE)	OIL PUMP ROTOR MD 009047

FUEL PUMP

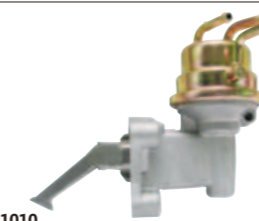
MITSUBISHI SERIES

MI-1008	REFERENCE NO. OEM NUMBER	CAR & MODEL	ENG.	YEAR	TYPE & REMARKS
	MD 176202 DW024 MP-924	4 CYCLE AND 6 CYLINDER	550cc- 2600cc		SHAGAL STEEL
	MP642 MD027080-C 1516772(GKN) MD138586 DW004	GACANT (JAPAN VAN USA, EUROPE) CANTER L04 SIGMA MONTERO	G52 4G54 2000cc		STEEL OIL PUMP MD025550 B/S:41487
	MP790	mitsubishi			

FUEL PUMP ISUZU SERIES

I-1001	REFERENCE NO. OEM NUMBER	CAR & MODEL	ENG.	YEAR	TYPE & REMARKS
	DW495 8-94438-533-0 1400 8-94438-533-1	LUC KB 21/41 TROOPER II	2254CC (4ZD)W/car	87-88	STEEL
	DW491 8-94238-600-0 8-94238-600-ZG GMC94238600 B-8301 8-94235-600-0 AP911 DW499	TROOPER II 2,000 PICK UP (4 CYL) CHEV. LUE. (USA) PUP 4 CYL 2238CC W/C 223 "DIESEL"	LV G200Z W/CARB 1949CC/ 1.9L	81-85	STEEL

FUEL PUMP

RUSSIAN CAR SERIES

REFERENCE NO. OEM NUMBER	CAR & MODEL	ENG.	YEAR	TYPE & REMARKS
2101-1106010 701-1106010-01	LADA	1200 1.2L	1198cc	74-85
		1300 1.3L	1294cc	78-82
		1500 1.5L	1452cc	73-86
		1600 1.6L	1570cc	78-84
		NIVA 1.6L	1568cc	77-91
		RIVA 1.2L	1198cc	83-90
		1.3L	1294cc	83-92
		1.5L	1452cc	85-90
		1.6L	1570cc	86-92
RU-1001	IN Ø8 OUT Ø8			

REFERENCE NO. OEM NUMBER	CAR & MODEL	ENG.	YEAR	TYPE & REMARKS
2108-1106010 702-1106010-01	SAMARA	1.1L	1099cc	90-92
		1.3L	1288cc	87-92
		1.5L	1499cc	88-92
	VAZ 2109			
	VAZ2108			
RU-1002	IN Ø8 OUT Ø8			

REFERENCE NO. OEM NUMBER	CAR & MODEL	ENG.	YEAR	TYPE & REMARKS
412-1106010 700-1106010-01	MOSKVICH			
RU-1003	IN Ø8 OUT Ø8			

REFERENCE NO. OEM NUMBER	CAR & MODEL	ENG.	YEAR	TYPE & REMARKS
901-1106010-21	GAZEL 406			
RU-1004	IN Ø8 OUT Ø8			

REFERENCE NO. OEM NUMBER	CAR & MODEL	ENG.	YEAR	TYPE & REMARKS
900-1106010-01	UAZ 3151			
RU-1005	IN Ø8 OUT Ø8			

REFERENCE NO. OEM NUMBER	CAR & MODEL	ENG.	YEAR	TYPE & REMARKS
901-1106010-01	VOLGA GAZ 402			
RU-1006	IN Ø8 OUT M14x1.5			

REFERENCE NO. OEM NUMBER	CAR & MODEL	ENG.	YEAR	TYPE & REMARKS
2101-1106010 BCD 2003/5 8520 45655 247108 4102819 4384373 4163954	LADA FIAT			
RU-1007	IN Ø8 OUT Ø8			

FUEL PUMP

RUSSIAN CAR SERIES

REFERENCE NO. OEM NUMBER	CAR & MODEL	ENG.	YEAR	TYPE & REMARKS
2108-1106010 BCD2624 GP PB49 SOFABEX 8521	LADA			
RU-1008				

REFERENCE NO. OEM NUMBER	CAR & MODEL	ENG.	YEAR	TYPE & REMARKS
BCD2003/5 2101-1106010 4102819 4384373 4163954 4265 247108 9.06.121.11	LADA	1500	1973-1985	21043 stationwogon
	LADA	1200,1300,1500	1978-1984	2105
	LADA	1300,1500,1600		2107
	LADA	1600		NIVO
RU-1009	IN Ø8 OUT Ø8			

REFERENCE NO. OEM NUMBER	CAR & MODEL	ENG.	YEAR	TYPE & REMARKS
BCD2192	MOSKVICH			
RU-1010				

REFERENCE NO. OEM NUMBER	CAR & MODEL	ENG.	YEAR	TYPE & REMARKS
BCD2164/5 247137 25066483 4250477 4365252 4427880 4434835 4452648	461-11	BC-118	AUTOBIANCHI	1050-70 HP
	60338	BC-238	AUTOBIANCHI	1050
	60339	MS-60338-S	FIAT	1100,1300
	7703714	POC 087	FIAT (Argentina)	1050
	7718702		FIAT (Brasile)	1300,1500
	8060		INNOCENTI	1300
	9.06.141.11		LADA (Brasile)	1100,1300
	AB-601			1050,1100,1500
				1050
RU-1011	IN Ø8 OUT Ø8			

REFERENCE NO. OEM NUMBER	CAR & MODEL	ENG.	YEAR	TYPE & REMARKS
2101-1106010	LADA			
RU-1012	IN Ø8 OUT Ø8			

REFERENCE NO. OEM NUMBER	CAR & MODEL	ENG.	YEAR	TYPE & REMARKS
703-1106010-01 1102-1106010	ZAZ 1102			
RU-1013	IN Ø8 OUT Ø8			

REFERENCE NO. OEM NUMBER	CAR & MODEL	ENG.	YEAR	TYPE & REMARKS
2108-1106010	LADA			
RU-1014				

FUEL PUMP

RUSSIAN CAR SERIES

REFERENCE NO. OEM NUMBER	CAR & MODEL	ENG.	YEAR	TYPE & REMARKS
BCD 2627 2108-1106010 2108-910610 7.21772.50 BC-237 FT-005 POC 620	Lada-Vaz Samara C arlota Sputnik(2018) Samar Sputnik(2019) Samara,Forma	1.1-1.3-1.5 Lt Lada -Vaz Carb 1.1-1.3-1.5 Lt Lada -Vaz Carb 1.1-1.3-1.5 Lt	1987-1992	

RU -1015 IN Dia.8 OUT Dia.8

FUEL PUMP LAND ROVER SERIES

REFERENCE NO. OEM NUMBER	CAR & MODEL	ENG.	YEAR	TYPE & REMARKS
BCD 2573 25066213 461-112/386 550324 563146 7950445 AH-002 PON 103 25061502	LEYLAND-ROVER ROVER	Sherpa 88 & 109 Serie IIA	1961-1971 1961-1971	2,5 Diesel Diesel 2 1/4

LR-1001 IN 1/2"-20 UNF OUT 1/2"-20 UNF

REFERENCE NO. OEM NUMBER	CAR & MODEL	ENG.	YEAR	TYPE & REMARKS
BCD 2654 25061527 25066025 3851 461-181 536146 563146 7971192	ROVER ROVER ROVER SANTANA	110 88 & 109 IIA 88 & 109 II LAND ROVER 90,110	1983-1984 1961-1971	2300 Diesel 21/4 L.Diesel (Suffix K) 21/4 Lit.Diesel 2500 Diesel CC-DL

LR-100 2 IN 1/2"-20 UNF OUT 1/2"-20 UNF

REFERENCE NO. OEM NUMBER	CAR & MODEL	ENG.	YEAR	TYPE & REMARKS
BCD 2574 25061503 3852 3853 461-113 501735 549761	ROVER	2200 PETROL1 1/4 6CIL.PETOL2 1/4	1983-1985 1971-1984 1971-1984	

LR-100 3 IN 1/2"-20 UNF OUT 1/2"-20 UNF

REFERENCE NO. OEM NUMBER	CAR & MODEL	ENG.	YEAR	TYPE & REMARKS
BCD 2718 ERR 5057 RV-002 93152687	LAND ROVER DEFANDER 300 TDI LAND ROVER DISCOVERY TDI	DT 2,5LT (68 HP)		

LR-100 4 IN Ø8 OUT Ø8

REFERENCE NO. OEM NUMBER	CAR & MODEL	ENG.	YEAR	TYPE & REMARKS
BCD 2669 25066223 461-383 93151739 ETC 7869 RV-001	LAND ROVER 110 LAND ROVER 90 LAND ROVER Discover TDI	Diesel 2.5 Lt Diesel 2.5Lt 2.5Lt		

LR-100 5 IN 1/2"-20 UNF OUT 1/2"-20 UNF

FUEL PUMP

LAND ROVER SERIES

REFERENCE NO. OEM NUMBER	CAR & MODEL	ENG.	YEAR	TYPE & REMARKS
BCD 2606 25061618 461-337 93151334 PON 106	Leylang Rover Sherpa Land Rover 90/110	Diesel 2.5 Lt Diesel 2.5 Lt	1984-05.88	

LR -1006 IN 1/2"-20 UNF OUT 1/2"-20 UNF

REFERENCE NO. OEM NUMBER	CAR & MODEL	ENG.	YEAR	TYPE & REMARKS
BCD 2653 549761-F2 AH-016	Santana Land Rover 110	DC-DL Benzina 2.5Lt		

LR -1007 IN 1/2"-20 UNF OUT 1/2"-20 UNF

FUEL PUMP PAYKAN SERIES

REFERENCE NO. OEM NUMBER	CAR & MODEL	ENG.	YEAR	TYPE & REMARKS
1235900 1238590 1238591 1240098 1247112 25061260 25061517 25061553 25061560 461-156	461-157 461-196 461-241 461-257 71261471 717180116 71804059 71804116 71804116 7971009 79711010	PAYKAN TALBOT TALBOT TALBOT TALBOT TALBOT TALBOT TALBOT TALBOT TALBOT TALBOT	...1990 195-1970 1967... 1967... 1966-1970 1966-1976 1965-1970 1966-1976 ...1976 1966-1976 1965-1976 1972 ...1976	talbot humber 1500,2500 4 cil 4 cil - - 1.7 ohv 1.7 lit./ohv 1725cc 1.5 ohv 1.7 ohv 1.7 ohv 1.7 lit./ohv 1725cc

PA-1001 IN Ø8 OUT Ø8

REFERENCE NO. OEM NUMBER	CAR & MODEL	ENG.	YEAR	TYPE & REMARKS
1336185	PAYKAN			

PA-1002 IN Ø8 OUT Ø8

REFERENCE NO. OEM NUMBER	CAR & MODEL	ENG.	YEAR	TYPE & REMARKS
BCD 1791/5 1235900 1238590 1238591 1240098 247112 25061260 25061517 25061553 25061560 461-156 461-157 461-196	461-241 461-257 71261471 717180116 71804059 71804116 7971009 7971010 7971275 7990052 7990149 8120 AO-055	Chrysler Europe Commer Dodge Paykan	Hillman Estate Hillman Hunter GT Hillman Husky III Hillman Minx, Super Minx Humber Sceptre Humber Sceptre H 120 C/altern. Singer Gazelle VI-Vogue Sunbeam Alpine, H120, Rapier v Sunbeam Hunter Sunbeam Rapier PA/PB/PB PAYKAN	(OHV)1.7 Lt Talbot 1725 cc (OHV)1.7 Lt (OHV)1.5 Lt Talbot 1725 cc (OHV)1.7 Lt (OHV)1.5-1.7 Lt Talbot 1725 cc (OHV)1.7 Lt 1.5-2.5 Lt 4 cil 4 cil Talbot Humber

PA -1003 IN 1/2"-20 UNF OUT 1/2"-20 UNF

FUEL PUMP

RENAULT SERIES

R-1001		REFERENCE NO.		CAR & MODEL	ENG.	YEAR	TYPE & REMARKS
		OEM NUMBER					
		BCD 1986/5	77.00.01.349.266	OYAK(Turchia)	1100,1250	1987-7/85	9GTL
		DW539	7.21746.50	RENAULT	1400	3/1983	R11
		25061429	8035		1100	3/1983	R11GTS TSE
		25066363	8047		1400		R11
		3489003	9.06.287.11		1100,1400		TC,GTC,Societe
		461-83/94	BC-109		1100	3/1983	R11 TL,GTL
		5506956	LI-035		1400	1981-7/85	Automatica
		77.00.349.266	MS-60495-S	RENAULT	1400	9/1981	R9 R19 TR,TRE
		77.00500.194	PL 3047	(Argentina)	1397cc-Mot	9/1981	R9 C.TC,GTC,TCE,L
		77.00.696.974	POC 304		847.00x	9/1981	GTS,TSE,TCE,L,Auto
					0.1 1980	9/1981	R9 TL,GTL,TLE
							R9,R11

R-1002		REFERENCE NO.		CAR & MODEL	ENG.	YEAR	TYPE & REMARKS
		OEM NUMBER					
		BCD 1778/5	77.00.653.611	8017	DACIA(Romania)	R12	6/1970
		DW540	77.00.509.109	8034		R1360	3/1980
		25061447	77.00551.669	BC-112	OYAK(Turchia)		9/1969
		25066361	77.00.614.533	LI-006	RENAULT	R1300	10/1971
		247101	77.00.633.708	MS-60496-S		1400	4/1978
		3277579	77.00.681.700	PL 3017			
		3277579-5	77.01348.612	PL 3034		B14	1981
		247103	7.21740.50	POC 544	RENAULT-EAST	B14	1978
		5506924	7.21742.50		VOLVO	408CC	1978

R-1003		REFERENCE NO.		CAR & MODEL	ENG.	YEAR	TYPE & REMARKS
		OEM NUMBER					
		BCD2555/6		RENAULT	1721 Lt.	7/1987...	R21
		3342128		VOLVO	F2N 1700	7/1987...	R21 Nevada
		3344221280			F2N 1700	1985-1989	R5 GTX Baccara
		77.00.734.727			1700	1982...	340
		77.00.735.148			1700	1988-1991	360 GLE
		7.21777.50			1700	1989-1991	440
		8360001					460
		POC660					
		PV8738					

R-1004		REFERENCE NO.		CAR & MODEL	ENG.	YEAR	TYPE & REMARKS
		OEM NUMBER					
		BCD2646/1		RENAULT	C1C 956	7/1990...	Clio RL,RN
		77.00.740.188			C1E 1100	7/1990...	Clio RL,RN
		77.00.740.194			C16	7/1987...	R19 Chamade TR,TRE
		PV8743			1200,C1G1400		GTR
		POC625			C16 1200	7/1987...	R19 GTR
					C1G1400	7/1987...	R19 TR
					C16 1200	7/1987...	R19 TR,TRE
					C1200	7/1987...	Supercinque TR,GE

R-1005		REFERENCE NO.		CAR & MODEL	ENG.	YEAR	TYPE & REMARKS
		OEM NUMBER					
		PL3005N	5506915	77.01.018.426	R10,R12	R12,R8	1953-1962
		BCD 1889/5	70.02.103.370	77.01.348.210	R16,R16L,TL,R16 TA	R2136,R2137	1970...
		08.54.512.600	77.00.633.544	77.01.348.241		R1120,R1121	1968...
		08.55.438.500	77.00.654.475	77.02.103.370	R3,R4 Furgonette F4	R2381R12	1961-1971
		25061440	77.00.514.429	8.554.621	R4,TL,Rodeo,Safari	R8,R8 Goesini	1966-5/70
		25061441	77.00.518.857	8005	R5 Societe	R1123,R1126	1968-1970
		25066265	77.00.527.329	9.06.120.11	R8,R8 Gordini	Renault 1108	1968-1970
		25066410	77.00.527.329	BC-121	R8,R8 Major	Renault 1300cc	10/68-1/80
		3001	77.00.835.741	LI-002	Daf55.66	PL 1007	1969-7/75
		4641-28/29	77.00.640.440	PL 1007	Volvo 66	POC 100	
		5.548.544	77.00.698.996	PL 3006			
		5506914	77.01.00969	POC 100			

R-1006		REFERENCE NO.		CAR & MODEL	ENG.	YEAR	TYPE & REMARKS
		OEM NUMBER					
		BCD 2549/1	PL8744	RENAULT	950,1108,1200	1986	Express
		77.00.728.131	POC 638		1400		R11
		77.00.276.305			1397	7/84-1993	R21 TL,GTL
		77.00.726.305				8/1985	R5, Van
		77.00.728.131			1100,1200,1400	9/1984	Supercinque GL
		77.00.734.250			1100,1250,1400		GT
		7.21780.50		RENAULT-FAST	1108,1397	1986	Autom
		BC-128		(Spagna)			R9,R11
		PL3744					

R-1007		REFERENCE NO.		CAR & MODEL	ENG.	YEAR	TYPE & REMARKS
		OEM NUMBER					
		BCD 1984/5	77.00.666.046	RENAULT	122B-Mot.840	1983-7985	R5 ALPINE TURBO
		247118	77.02.144.230	RENAULT	R1395	3/76-5/79	R5 GTL
		25061435	7.21745.50	RENAULT	R1225	5/1778	R5 GTL Automatica
		25066429	8046	RENAULT	R2382	7/1984	R5 Laureate L,TL,GTL
		461-65/91	90530462	RENAULT	R1222	10/75-1979	R5 Societe
		5506908	9.06.110.11	RENAULT	R1228	4/1973...	R5 TL
		5507917	BC-199	RENAULT-FAST(Spagna)	RCLIA	6/1975...	R5 USA
		77.00.730.665	BC-170	RENAULT-FAST(Spagna)		1973...	R4,R5,R7
		77.00.566.659	LI-005				
		77.00.641.235	PL 3046				
		77.00.646.046	POC 302				

FUEL PUMP

RENAULT SERIES

R-1008		REFERENCE NO.		CAR & MODEL	ENG.	YEAR	TYPE & REMARKS
		OEM NUMBER					
		351602285000					
		PLN8238/148短					

R-1009		REFERENCE NO.		CAR & MODEL	ENG.	YEAR	TYPE & REMARKS
		OEM NUMBER					
		351602314000					

R-1010		REFERENCE NO.		CAR & MODEL	ENG.	YEAR	TYPE & REMARKS
		OEM NUMBER					
		351602302000					

R-1011		REFERENCE NO.		CAR & MODEL	ENG.	YEAR	TYPE & REMARKS
		OEM NUMBER					
		351602294000		RENAULT			

R-1012		REFERENCE NO.		CAR & MODEL	ENG.	YEAR	TYPE & REMARKS
		OEM NUMBER					
		351602333000		RENAULT			

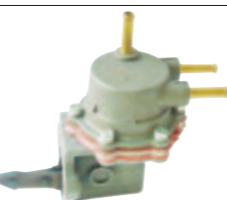
R-1013		REFERENCE NO.		CAR & MODEL	ENG.	YEAR	TYPE & REMARKS
		OEM NUMBER					
		247101	77.00.653.611	BC-112	DACIA(Romania)	-	1210,1310,1320
		247103	77.00.509.109	LI-006	OYAK(Turchia)	-	1410
		25061447	77.00.531.547	MS-60496-S	RENAULT	-	12 TX,12 TSW
		25066361	77.00.614.533	PL 3017	RENAULT	R 12	6/1970...
		3267347-7	77.00.633.708	PL 3034	RENAULT-FAST	R 1360	3/1980...
		3277579	77.00.681.700	POC 544	VOLVO	R 1360	9/1969...
		3277297	77.01.348.612			R 1300	10/1971...
		3277597-5	7.21740.50			1400	4/1978...
		461-37	7.21742.50			-	1981...
		5506924	8017			B 14	1978...
		60.00.557.831	8034			B 14	1978...
						408CC	-
							66

R-1014		REFERENCE NO.		CAR & MODEL	ENG.	YEAR	TYPE & REMARKS
		OEM NUMBER					
		351602343000		RENAULT			

FUEL PUMP

RENAULT SERIES

R-1015		REFERENCE NO. OEM NUMBER		CAR & MODEL	ENG.	YEAR	TYPE & REMARKS
		351602345000	RENAULT				
IN Ø6 OUT Ø6							

R-1016		REFERENCE NO. OEM NUMBER		CAR & MODEL	ENG.	YEAR	TYPE & REMARKS
		351602158000	RENAULT				

R-1017		REFERENCE NO. OEM NUMBER		CAR & MODEL	ENG.	YEAR	TYPE & REMARKS
			RENAULT				

R-1018		REFERENCE NO. OEM NUMBER		CAR & MODEL	ENG.	YEAR	TYPE & REMARKS
		351602310000	RENAULT				

R-1019		REFERENCE NO. OEM NUMBER		CAR & MODEL	ENG.	YEAR	TYPE & REMARKS
		351602177000	RENAULT				

R-1020		REFERENCE NO. OEM NUMBER		CAR & MODEL	ENG.	YEAR	TYPE & REMARKS
		5506924 461-37 1779/1 8017	RENAULT				

R-1021		REFERENCE NO. OEM NUMBER		CAR & MODEL	ENG.	YEAR	TYPE & REMARKS
		BCD 1985/5 247163 25061436 25066430 461-68/92 5506909 5507921 77.01.039.609 77.00.555.728 77.00.565.728	LI-005/0 PL 3044 POC 305	RENAULT RENAULT RENAULT RENAULT RENAULT RENAULT RENAULT-FAST (Spagna)	112c/201c.956cc 950 R1223 R1225,R1395, R1399 R1226,R1396 R1224 R2386,R2387 R1226,R1227 R1394,R1397 R1224 R1229	1986-1990 ...1984 3/1976... 5/1979... 7/1984... 3/1976... 5/1979... 5/1979...	R4 R5 R5 Alpine R5 GTL R5 Laureate Turbo R5 Le Car,TS,LS R5 Societe R5 TL,GTL R5 TL,GTL,LS,TS R5 TS,TX,Automatica R4,R4 F6,R5 TS,R7

FUEL PUMP

RENAULT SERIES

R-1022		REFERENCE NO. OEM NUMBER		CAR & MODEL	ENG.	YEAR	TYPE & REMARKS
		BCD 1783/5 247079 2561449 25066413 461-40 5506931 77.00.520.928 77.00.544.500	77.00.634.554 77.01.348.614 8014 LI-003 PL3014	RENAULT RENAULT RENAULT RENAULT RENAULT RENAULT	R2370,R2330 R2430 R1128 R1181	R2370,R2330 R2430 R1128 R1181	4/1975... 1961-1981 4/1975... 1/1978... 10/70-1980

R-1023		REFERENCE NO. OEM NUMBER		CAR & MODEL	ENG.	YEAR	TYPE & REMARKS
		BCD 2549/1 247072 77.00.728.131 77.00.276.305 77.00.726.305 77.00.734.250 7.21780.50	8744 BC-218 PL 3744 PL 8744 POC 638	RENAULT RENAULT RENAULT RENAULT RENAULT RENAULT-FAST(Spagna)	950,1108,1200,1400 1397 1100,1200,1400 1100,1250,1400 1108,1398	950,1108,1200,1400 1397 1100,1200,1400 1100,1250,1400 1108,1398	1986... 7/84-1993 8/1985... 9/1984... 1986...

R-1024		REFERENCE NO. OEM NUMBER		CAR & MODEL	ENG.	YEAR	TYPE & REMARKS
		BCD 2640 474663 77.00.716.997 77.00.741.339 77.00.742.566 8751 BC-200 POC 642		RENAULT RENAULT RENAULT RENAULT	E5F 1200 E6J 1400 6EJ 1400 63J 1400	E5F 1200 E6J 1400 6EJ 1400 63J 1400	7/1990... 1990-1993 9/1988... 7/1990...

R-1025		REFERENCE NO. OEM NUMBER		CAR & MODEL	ENG.	YEAR	TYPE & REMARKS
		BCD 2548/6 247069 25061430 25066369 3489005 3736 461-95 77.00.723.168 77.00.733.545	7.21776.50 BC-214 LI-60 PV 3836 PV 8736	RENAULT RENAULT RENAULT RENAULT RENAULT RENAULT RENAULT RENAULT RENAULT(Argentina)	1700 1700 1700 1700 1600	1700 1700 1700 1700 1600	9/1988... 3/1983... 9/1988... 1986 3/1984... 9/1988... 9/1988...

R-1026		REFERENCE NO. OEM NUMBER		CAR & MODEL	ENG.	YEAR	TYPE & REMARKS
		BCD 2623 247096 247151 3049 474662 77.00.749.253 77.00.743.727 77.00.851.879 77.00.853.480	77.00.860.573 8728 8729 8739 LI-060/1	RENAULT RENAULT RENAULT RENAULT RENAULT RENAULT RENAULT RENAULT	1533 F2N 1700 2100 F2N 2100 F2N 1700-B53M,G53M 1700 1,F2N-711/720/721/754	1533 F2N 1700 2100 F2N 2100 F2N 1700-B53M,G53M 1700 1,F2N-711/720/721/754	1989-1993 7/1990... 1980... 1983-1992 1980... 9/1988... 7/1991...

R-1027		REFERENCE NO. OEM NUMBER		CAR & MODEL	ENG.	YEAR	TYPE & REMARKS
		BCD 1779/1 110779 247054 247110 25066403 3950 461-246 50.00.592.768	50.00.044.183 7990084	RENAULT(RVI) SAVIEM(RVI)	671 4 Cil.	671 4 Cil.	1962...

R-1028		REFERENCE NO. OEM NUMBER		CAR & MODEL	ENG.	YEAR	TYPE & REMARKS
		BCD 1779/3 25066403 461-246 50.00.044.183 799084 50.00.133.873		ALFA ROMEO RENAULT(RVI) SAVIEM(RVI)	PERKINS 671 712/720 4 CIL 712/720 4 CIL	PERKINS 671 712/720 4 CIL 712/720 4 CIL	1962

FUEL PUMP

RENAULT SERIES

REFERENCE NO. OEM NUMBER	CAR & MODEL	ENG.	YEAR	TYPE & REMARKS
BCD 1669/5 6 0520 19 0 0004 7.1509.50 F150.204.710.011	Fendt MWM Schlepper FW 258 Industriale Industriale Industriale Industriale Renault Trucks Industriale Industriale Industriale Trattore	MWM D225-6(90 HP) 208/308(19.84 HP) MWM D226(22.125 HP) MWM D301-2(20 HP) MWM D302(7.27 HP) MWM D322 D325(26 90HP) MWM D327(20.112 HP) MWM TD208(70-90 HP) MWM TD226-6(100-150 HP) MWM D322	1964-... 1968-... 1967-1969 1971-... 1966-... 1966-... 1966-... 1972-... 01.67-1970	09.67-1968 1964-... 1968-... 1967-1969 1971-... 1966-... 1966-... 1966-... 1972-... 01.67-1970

R -1029 IN M14x1.5 OUT M14x1.5

REFERENCE NO. OEM NUMBER	CAR & MODEL	ENG.	YEAR	TYPE & REMARKS
BCD 1865/6 7.21767.50 132.211 75492254 25061453 8109 3312 8312 3314 8314 461-45 8314 474655 9.06.800.11 5428535 90533122 5428536 95493324 5428537 95493367 5467097 95493367 5491102 95648551 5506938	Citroen Ami 8 Super Axel'11 R' Axel'12 R' Entreprise GS 1015, GS,1220 GS X3,GS,GSA GSA Special, Break Special Axel 11R-12R Club 11R,12TRS	1015,1130,1270 cc 1.0-1.1-1.3 Lt 1129 cc 1.1 Lt 1295 cc 1.3 Lt 1129 cc 1.1 Lt 1129 cc 1.1 Lt 1129 cc 1.1 Lt 1129 cc 1.1 Lt 1297 cc 1.3 Lt	1970-1976 07.84-... 07.84-... 1980-... 09.70-... 09.70-... 1980-... 1981-...	09.70-1976 07.84-... 07.84-... 1980-... 09.70-... 09.70-... 1980-... 1981-...

R -1030 IN 1/2"-20 UNF OUT 1/2"-20 UNF

REFERENCE NO. OEM NUMBER	CAR & MODEL	ENG.	YEAR	TYPE & REMARKS
BCD 1874/5 77 00 632 708 247106 77 00 636 253 25061474 77 00 663 580 25066411 77 00 636 382 3019 77 01 348 613 461-82 77 01 349 244 5506972 8033 7.21755.50 8719 77 00 436 253 9.06.349.11 77 00 532 985 BC-108 77 00 532 987 LI-040 77 00 551 384 PL 3719 77 00 556 887 POC 641	Renault Fuego GL R16 L,TL,TA R18 TS,GTS,TA Break Trafic Trafic T...1,P...1	R1361-Mot.A2M R1150,1152,1153 1155,1157 R1341,R1351 (1650 cc)1.7 Lt 841-05,A1M (1647 cc)1.7 Lt	1984-1985 06.72-1980 04.78-... 1984-1993 1980-...	1984-1985 06.72-1980 04.78-... 1984-1993 1980-...

R -1031 IN M10x1.0 OUT M10x1.0

REFERENCE NO. OEM NUMBER	CAR & MODEL	ENG.	YEAR	TYPE & REMARKS
BCD 1876/5 8301 247078 90533002 25066472 DV 173 0A 3301 PL 3300 461-60 POC 515 5447891 5463333 5463334 5506903 8300	Citroen C35 D Special,D Super, D Super 5 DS 20 DS 23 carburatore	1985 cc 2.0 Lt	1973-1977 09.67-1975 09.73-1975 09.73-...	09.73-1977 09.67-1975 09.73-1975 09.73-...

R -1032 IN Dia.8 OUT Dia.6

REFERENCE NO. OEM NUMBER	CAR & MODEL	ENG.	YEAR	TYPE & REMARKS
BCD 1904/3 461-286 50 00 048 052 50 00 049 965 50 00 592 528 50 00 592 767 7990485 90539512 PL 3951 PON 119	Saviem Serie,JK60,JK65,JK75	Saviem 720 (4 cil)		

R -1033 IN M12x1.0 OUT M12x1.0

REFERENCE NO. OEM NUMBER	CAR & MODEL	ENG.	YEAR	TYPE & REMARKS
BCD 1955/6 25061465 461-70 5506958 7.20934.51 8.160.51 8448 MS-6969-S	Citroen C 35 CX	Benzina 2.0-2.2-2.4 Lt	08.79-...	08.79-...

R-1034 IN Dia.8 OUT Dia.6

REFERENCE NO. OEM NUMBER	CAR & MODEL	ENG.	YEAR	TYPE & REMARKS
BCD 1983/5 08 55 809 600 08 55 970 100 461-61 5506973 77 01 017 595 77 01 349 383 905 30002 PL 3000	Fenwick Renault Carrelli elevatori Alpine A110 1500 R16 L,TL,TA	Renault 1470 cc (R16) 1.5 Lt R1150,R1152,R1153	1966-1967 1968-06.72	1966-1967 1968-06.72

R -1035 IN Dia.6 OUT Dia.6

FUEL PUMP

RENAULT SERIES

REFERENCE NO. OEM NUMBER	CAR & MODEL	ENG.	YEAR	TYPE & REMARKS
BCD 2515 Fendt 6 0520 19 0 0012 7.20136.50 F312.200.710.041 PX-103	Farmer 308,309,310 Farmer 311,312 Favorit 509 C,510C Favorit 511 C Favorit 512 C,514C,515 C MWM Renault Trucks Trattore	MWM TD226.B4 4.1 Lt/86-95-105 HP MWM D226.B6.TD226.B6 6.2 Lt MWM TD226.B6 4.1 Lt/95-105 HP MWM D226.B6 6.2 Lt/115 HP MWM TD226.B6 6.2 Lt/125-140-150 HP MWM D226-4(65-75-80HP) MWM D 226-4	1993-2000 1993-2000 1993-1999 1993-1999 1993-1999	1993-2000 1993-2000 1993-1999 1993-1999 1993-1999

R -1036 IN M14x1.5 OUT M14x1.5

REFERENCE NO. OEM NUMBER	CAR & MODEL	ENG.	YEAR	TYPE & REMARKS
BCD 2551 Renault 247104 77 00 670 936 LI-004 PL 3035	Trafic	847-00,01(1397 cc)1.4 Lt	10.80-...	10.80-...

R -1037 IN Dia.6 OUT Dia.6

REFERENCE NO. OEM NUMBER	CAR & MODEL	ENG.	YEAR	TYPE & REMARKS
BCD 2649/1 Renault 247164 77 00 736 664 8714	R4 ,L,TL(R1120)	Renault CIC-708	07.86-...	07.86-...

R -1038 IN Dia.6 OUT Dia.6

REFERENCE NO. OEM NUMBER	CAR & MODEL	ENG.	YEAR	TYPE & REMARKS
PV3047				

R -1039

REFERENCE NO. OEM NUMBER	CAR & MODEL	ENG.	YEAR	TYPE & REMARKS
PV3003				

R -1040

FUEL PUMP PEUGEOT SERIES

REFERENCE NO. OEM NUMBER	CAR & MODEL	ENG.	YEAR	TYPE & REMARKS
BCD 1875/6 25066362 8203 1450.11 3224 8205 1450.14 461-27 8224 1450.16 461-32 BC-106 1450.22 5506913 CZ-055 1450.30 5506918 PL3202 1450.74 791002069 PL 3203 1450.76 7.21747.50 PL 3205 25061444 8202 PL 3252	CITROEN PEUGEOT 505	1800,200 (Benzina) 504L,GL,GR,SR,S 1600 1800,2000 1800,2000 XNIA,XN8-Benzina Benzina Benzina 1600,2000 Benzina	9/1982 2/1961 3/1960 10/1968 5/1979 11/81-82 1965 1/1980 1981-82	C25 203 403/7,403 404 504L,GL,GR,SR,S 505 GL,GR,SR D 3 A-D 4A-VAN J5,J7,J9 Jeep P 4

P-1001 IN Ø6 OUT Ø6

FUEL PUMP

PEUGEOT SERIES

REFERENCE NO. OEM NUMBER	CAR & MODEL	ENG.	YEAR	TYPE & REMARKS
BCD 2552/1 1450.73 1450.86 7.21764.50 PL8223 PL3223	PEUGEOT	XNA,XMA XN1A-XM7A- GL,GR,SR	1991 7/1985	504 PU(CHINA) 505

REFERENCE NO. OEM NUMBER	CAR & MODEL	ENG.	YEAR	TYPE & REMARKS
BCD 2553/6 1450.57 1450.96 247076 25061480 3219 461-355 8219	CITROEN PEUGEOT 505	XU 1905 XU 1580 Xu5 1905 XU 1600 1905 XU,XU5 1580(XU51C) 1580(XU5-2C) (SU9-2C) 9/1985... XU-2.0 Lit I	84-1992 7/84-7/85 1991-1993 1989-1992 1/1984... 9/84-7/85 2/1984... 9/1985... 5/1987...	BX15,16,19RS,TRS BX19GT Xm21 205 305GT 305GTX 305 S,GT 309 GR,SR 405 605

REFERENCE NO. OEM NUMBER	CAR & MODEL	ENG.	YEAR	TYPE & REMARKS
PLN 3202 BCD 1875/6	PEUGEOT 504	504L,GR,SR(10/68) 505GR,SR,(5/79 7/1) (203,403,403,7,404, D3A,D4A,J7) CITROEN C25 RENAULT		STEEL

REFERENCE NO. OEM NUMBER	CAR & MODEL	ENG.	YEAR	TYPE & REMARKS
BCD 2512/6 1450.58 1455.02 247061 25061432 3217 3489007 461-89 461-97 5506953	CITROEN CITROEN CITROEN CITROEN CITROEN PEUGEOT PEUGEOT	XU 1600 1580(XU) 1124 XU XU	1992... 9/82-12/83 1982-1/84 9/1982... 1983... 1992... 1982-1/84	BX 15,16,19 BX 16 RS,TRS BX 1600 BX Serie 14 LNA 205,309,405,605 305 S,GT

REFERENCE NO. OEM NUMBER	CAR & MODEL	ENG.	YEAR	TYPE & REMARKS
BCD 2599 1450.66 1450.74 1450.80 247064 247114 7.21765.50 8227 91518057	CITROEN CITROEN PEUGEOT PEUGEOT PEUGEOT PEUGEOT PEUGEOT PEUGEOT PEUGEOT	XU5 XU9 XU XU 1600 XU 1600,1900(SU) XU 1900 1600,1900,(XU)	7/85-/89 1985-1989 7/90-4/92 7/87-6/90 7/1985... 11/1985... 1989... 1993...	BX 15,16,19 BX 19 SPORT 205 205 305 GT,GTX 309 309 405 GL,GR,SR

REFERENCE NO. OEM NUMBER	CAR & MODEL	ENG.	YEAR	TYPE & REMARKS
BCD 2588/2 1450.84 1455.01 1455.03 247098 247099 7.21760.50 8208 8209	CITROEN CITROEN CITROEN CITROEN PEUGEOT PEUGEOT PEUGEOT PEUGEOT PEUGEOT	TU 1100 TU 954,1124 954 cc 1360 Carburatore TU 950,1100,1400 TU-3.2 TU 1100,1400	10/1986... 1987-1991 11/1988... 10/1988... 4/1991... 8/1991... 1989... 1993... 7/1989	AX 10 E,10 RE,TRE AX 10,11,14 AX 14 TZS AX 11 TRE BX 11 BX 14 C 15 Van ZX 10,11,14 106 XR 107 XT 205,1294,Rally 307 Expart 309

REFERENCE NO. OEM NUMBER	CAR & MODEL	ENG.	YEAR	TYPE & REMARKS
BCD 1706/5 6021	Bernard Moteurs Peugeot Vetus	Motore Industriale 403,404(Alcun trip) Motore Marino Motore Marino		Bernard Moteurs Tipo 32 Diesel Diesel M3.10(3.CIL)(22 HP) M4.14(4.CIL)(33 HP)

FUEL PUMP

PEUGEOT SERIES

REFERENCE NO. OEM NUMBER	CAR & MODEL	ENG.	YEAR	TYPE & REMARKS
BCD 1922/6 13221 1450.72 1450.79 247058 25061442 25066359 29988 34.634R 34546 461-30	Peugeot Simca Talbot	205(Spagna) 309 309(Tutti tipi) 1000(no Rallye) 1307 GL,S,S, 1308 GT,S 1309 SX Matra Bagheera Matra Rallye 1500 LS,1600 GLS 1510 Alpine(UK) Alpine,Premium Horizon LS,GL,GLS,EX Alpine,Premium	E1-G1 1100,1300,1.1-1.3 Lt E1-G1 1100,1300,1.1-1.3 Lt 1.1-1.3 Lt 1.0-1.1 Lt 6Y2 1442 cc 1.4 Lt 1.5-1.6 Lt 1.2-1.4 Lt	1987-1991 11.85... 1987... 10.68... 10.75... 10.75... 10.77... 08.76... 10.75-07.79 04.80-1986 07.75-1986 1978... 1982...

REFERENCE NO. OEM NUMBER	CAR & MODEL	ENG.	YEAR	TYPE & REMARKS
BCD 1923/5 131.885 450.77 247059 25061452 25066428 43.106Y 461-44 5506937 7.21759.50	Peugeot Simca Talbot	309 Svizzera 1100 TI 13075 Matra Bagheera Matra Bagheera S,X 1309 SX,1508,1609 SX(Svezia) 1510 SX Alpine SX,Solara Horizon Premium,Solara Horizon SX Rallye II	G2 3G4 6Y4 1294 Talbot 1592 cc Lt/90 cv Talbot 1592 cc Lt/90 cv 1.6 Lt	02.86-... 07.75-02.78 10.75-1979 06.73-09.78 09.77-... 07.75-08.79 09.79-10.82 1980-1982 1982-... 10.78-... 07.75-02.78

REFERENCE NO. OEM NUMBER	CAR & MODEL	ENG.	YEAR	TYPE & REMARKS
BCD 1925/6 1450.34 1450.52 1450.55 25061451 25061461 25066484 461-43 461-88 5506935 7.21749.50 77 00 704 262 77 01 348 117	Citroen Peugeot Renault Talbot	BX 14 (Trtti I tipi) BX 16 (Trtti I tipi) C 15 LN E,RE Visa (Trtti I tipi) Visa Super GT 104 (Trtti I tipi) 205 GL,GR,SR,S R14 L,TL,TS,GTL Samba	1360,1400,1.4Lt 1.1 Lt 1.1-1.4 Lt 1.1 Lt R1210,R1211,R1212	...-10.88 01.84-... 07.84-09.88 09.82-... 10.78-... ...-10.88 10.72-... 0.83-1988 06.76-1983 11.81-...

REFERENCE NO. OEM NUMBER	CAR & MODEL	ENG.	YEAR	TYPE & REMARKS
BCD 1995/6 1450.17 1450.27 1450.30 1450.32 1450.53 1450.75 25061473 3201 461-56 461-81 5506912	Peugeot	204 304,304 S 305 GL,GR,SR,S 403/8 403/U	1.1 Lt 1.1 -1.3Lt 1.3 -1.5Lt	1965-1976 10.68-1979 12.77 ...-02.61 12.60-...

FUEL PUMP VOLKSWAGEN SERIES

REFERENCE NO. OEM NUMBER	CAR & MODEL	ENG.	YEAR	TYPE & REMARKS
BCD 2637 026 127 025 026 127 025A 7.20803.51 8503 POC 600 056 127 025.1 056 127 025C	AUDI FORD (Brasile) SEAT VOLKSWAGEN PASSAT	1800(75/90 PS) 1300,1600(60/80 PS) AP 1600 1600,1800(75/90 PS) 1600,1800(75/90 PS) 1600,1800(75/90 PS)	1/85-8/86 2/85-8/86 8/82-8/86 9/84-8/86 2/1991... 1993... 1991... 1982... 11/1984...	100 C,CL,CS,GL 80C,CL,GL Coupe Belina,Delrey,Pampa EseortGhia,XR-3, Golf S,SL,GLS,Syncro Jetta S,SL,GLE,Sycro Passat C,CL,GL Santana C,CL,GL

REFERENCE NO. OEM NUMBER	CAR & MODEL	ENG.	YEAR	TYPE & REMARKS
BCD 1935/6-7 113 127 025E 113 127 025F 113 127 025G 7.20060.50 7.20170.50 7.20255.50 7.20804.51	VOLKSWAGEN	1200(34 PS) 1300(44 PS) 1200, 1600(34 /50PS) 1600(44 /48 PS) 1300(40 PS) 1600(50 PS)	8/1973... 1/1973... 1/1973... 8/1973... 9/1974... 1/734/79	TYPE1 TYPE1 1303 TYPE1 1303S TYPE18Furgon TYPE2 TYPE2

FUEL PUMP

VOLKSWAGEN SERIES

REFERENCE NO. OEM NUMBER	CAR & MODEL	ENG.	YEAR	TYPE & REMARKS
BCD 1787/5	AUDI	1800(75PS)	8/81-8/86	Golf C,CL,GL
021 127 025	FORD(Brasile)	1600	10/73-7/75	Golf S,SL,GLS Syncro
056 121 025 1		1600(100PS)	8/72-9/81	Jetta Jetta C,CL,GL
056 127 025	FOX	827	10/81-1/85	JettaS,SL,GLS Syncro
056 127 025 2	VOLKSWAGEN	1.3/1.5/1.6(55/85 PS)	10/80-8/84	PassatC,CL,GL
056 127 025 3		1800(90PS)	4/74-9/81	Passat Syncro
056 127 025 4		1300	10/81-6/83	Passat C,CL,GL
056 127 025 A	VOLKSWAGEN	1600(60/85PS)	9/79-9/81	Golf,Saveiro,Parafi,Voyage
056 127 025 B	-(Brasile)	1500,1600	10/80-9/84	Parati,Saveiro,Voyage
056 127 025 C		1600(75/90PS)	4/74-10/84	Passat (Tutti I tipi)
			1974-1976	Santana,Quantum

REFERENCE NO. OEM NUMBER	CAR & MODEL	ENG.	YEAR	TYPE & REMARKS
BCD 1868/7	AUDI	1100,1300(50/60PS)	9/74-7/77	Golf
036 127 025		1500(55PS)	2/68-8/71	Golf C,CL,GL
052 127 025A	VOLKSWAGEN	801 1300(55PS)	1/78-9/81	Jetta Jetta C,CL,GL
052 127 025B		1050,1100	3/77-9/81	Jetta C,CL,GL
052 127 025C		1300(40/60PS)	10/81-8/83	Passat 1300
052 127 025D		1300(60PS)	5/74-9/81	Passat C,CL,GL
052 127 025E		900,1100	9/79-9/81	Polo Coupe
052 127 025F		1300(40/50/60PS)	9/1983...	Polo Coupe GT
052 127 025H		1300(75PS)	9/1982...	Polo C,CL,GL
056 127 025E		1050,1300(40/60PS)	1981-1984	Santana
056 127 025H		1300(FY-FZ)	4/74-9/82	

REFERENCE NO. OEM NUMBER	CAR & MODEL	ENG.	YEAR	TYPE & REMARKS
BCD 2639/1	VOLKSWAGEN	1600(50PS)	5/1979...	TYPE2
025 127 025		1900(60/78PS)	9/1982...	TYPE2Syncro
070 127 025				
7.20255.51				
7.20840.50				

REFERENCE NO. OEM NUMBER	CAR & MODEL	ENG.	YEAR	TYPE & REMARKS
BAA-129-025B	VOLKSWAGEN	1600cc	75	
PE-20255-01	4CYL			
DW545	SEDAN.COMBI.			
	BRASILIA			
	SAFARIY HORMIGA			

REFERENCE NO. OEM NUMBER	CAR & MODEL	ENG.	YEAR	TYPE & REMARKS
BCD2593/1	VOLKSWAGEN			
030 127 025				
7.20884.53				
8508				
POC 680				

REFERENCE NO. OEM NUMBER	CAR & MODEL	ENG.	YEAR	TYPE & REMARKS
BCD 1739/6	VOLKSWAGEN			
113 127 025A				
113 127 025B				
113 127 025C				
211 127 025A				
POC543				

REFERENCE NO. OEM NUMBER	CAR & MODEL	ENG.	YEAR	TYPE & REMARKS
243122	VOLKSWAGEN			
243011				

VW-1011 IN Φ6 OUT Φ6

FUEL PUMP

VOLKSWAGEN SERIES

REFERENCE NO. OEM NUMBER	CAR & MODEL	ENG.	YEAR	TYPE & REMARKS
BCD 1952/5	Volkswagen	1460 cc 1.5 Lt/65 PS		06.78-...
055 127 025				
7.20568.00				

VW-1012 IN Dia.6 OUT Dia.6

FUEL PUMP KIA SERIES

REFERENCE NO. OEM NUMBER	CAR & MODEL	ENG.	YEAR	TYPE & REMARKS
KK150 13 350B	KIA			

K-1001 IN Φ8 OUT Φ6.5 RΦ5

REFERENCE NO. OEM NUMBER	CAR & MODEL	ENG.	YEAR	TYPE & REMARKS
P729	MAZDA 121(EXP)(USA)	B3		STEEL TYPE
DW582				
DW321				
B303-13-350				
B303-13-350B				
B303-13-350/C	FESTIVA(FORD)			
E82B-9350A	PRIDE(KIA),PRIDE VAN	1300CC		KIA.AL-TYPE

K-1002

FUEL PUMP AMERICAN SERIES

REFERENCE NO. OEM NUMBER	CAR & MODEL	ENG.	YEAR	TYPE & REMARKS
AIRTEX:40987	BUICK	8 CIL.305(5.0L),350(5.7L)	77-80	
	CHEVROLET	8 CIL.350(5.7L)	69-80	
BOSCH:68660	CHEVROLET	8 CIL.262,267,302,305,350	69-80	
	CHEVROLET & GMC	8 CIL.267,305(5.0L),350(5.7L)	69-79	
	TRUCKS	8 CIL.350(5.7L)	69-88	
	OLDSMOBILE	8 CIL.305(5.0L),350(5.7L)	77-80	
	PONTIAC	8 CIL.307(5.0L)	77-80	







AM-1001 IN Φ9.5 OUT 3/4-18UNF

REFERENCE NO. OEM NUMBER	CAR & MODEL	ENG.	YEAR	TYPE & REMARKS
40345	FORD,GALAXIE 500,LTD, MUSTANG, THUNDERBIRD, FAIRLANE,TORINO, COUGAR,MARQUIS, CMTAS.F-350-250/150 M/352,360,390,428	8 CIL	66/82	

AM-1002







FUEL PUMP

AMERICAN CAR SERIES

	REFERENCE NO. OEM NUMBER	CAR & MODEL	ENG.	YEAR	TYPE & REMARKS
 <p>AM-1003 IN Ø8 OUT 1/2-20UNF</p>	40446	CHEVROLET CAMARO,CAPRICE, IMPALA,NOVA,CHEVELLE,MALIBU, BEL AIR,BISCAYNE,CHEVY II Y CHEVY Y CMTAS.EL CAMINO, KE,P,G/10/20/30, BLAZER,VAN, CHEVY VAN,SUBURBAN M/153/194/230/250/292	6 CIL. 4 CIL	65/89	
	41216 40986	CHEVROLET CAPRICE, MONTECARLO,CAMARO, IMPALA,MALIBU,CHEVELLE, BEL-AIR,NOVA,CUTLAS, PONTIAC TODOS MODELOS, Y CMTAS.GMC Y CHEV. BLAZER,VANS SERIES P/10/20/30 C/G Y K/10/20/30 C/RETORNO AL TANQUE	8 CIL	72/90	
 <p>AM-1004</p>	41252	FORD 300			
	41446 41172	FORD THUNDERBIRD, CUSTOM,CUSTOM 500, LTD, TORINO, GRAND TORINO, GRANADA, MAVERICK,MUSTANG, GALAXIE,FAIRLANE, FALCON CMTAS.E 100/150/250/350 F 100/150/250/350,RANCHERO, BRONCO M/289/302/351/351(W) DE 4.7/5.0 Y 5.8L	8 CIL	66/79	
 <p>AM-1005</p>	AIRTEX:42196 60577	CASE CHRYSLER IND.DODGE DODGE TRUCK PLYMOUTH	6 CIL.170,225 6 CIL.170,225	64-70 60-81 60-87 60-81	
	BOSCH:68728		6 CIL.225 6 CIL.170,225		
 <p>AM-1006</p>	42197	DODGE,CHRYSLER, PLYMOUTH,AUTOS Y CAMIONETAS M/273/318/340/360 TODOS MODELOS (NO.BOCAR PE-602/05)	8 CIL	58/88	
	AIRTEX: 42152 60330	FORD BRONCO, FORD TRUCK FORD INDUSTRIAL UNITS FORD MERCURY	6 CIL.300(4.9L) 6 CIL.300(4.9L) 6 CIL.200,250	80-86 80-86 76-83 76-83	
 <p>AM-1007</p>	BOSCH:68422				
	60002				
 <p>AM-1008</p>	41249 6739	AMERICAN MOTORS MODELOS GREMLIM, PACER,MATADOR, HORNET,CONCORD, AMX,EAGLE,SPIRIT, JAVELIN MOTORES 151, 199,232,258 JEEP 4 Y M/151/232/258	6 CIL. 6 CIL.	70/90	
	41353 60007	FORD 35/M 400 FORD TRUCK LINCOLN MERCURY	8 CIL.351,400 8 CIL.351,400 8 CIL.351,400 8 CIL.351,400	70-79 70-79 70-79 70-79	
 <p>AM-1009 IN Ø9.5 OUT 1/2-20UNF</p>	60002				

FUEL PUMP

AMERICAN CAR SERIES

	REFERENCE NO. OEM NUMBER	CAR & MODEL	ENG.	YEAR	TYPE & REMARKS
 <p>AM-1010</p>	40781	DODGE 318/360			
	41209	CHEVROLET 231 FORD	V6-231(3.8L)		
 <p>AM-1011</p>	40669				
	40877	FORD CHRYSLER			
 <p>AM-1012</p>	41249 6739	AMERICAN MOTORS MODELOS GREMLIM, PACER,MATADOR, HORNET,CONCORD, AMX,EAGLE,SPIRIT, JAVELIN MOTORES 151, 199,232,258 JEEP 4 Y M/151/232/258	6 CIL. 6 CIL.	70/90	
	41353 60007	FORD 35/M 400 FORD TRUCK LINCOLN MERCURY	8 CIL.351,400 8 CIL.351,400 8 CIL.351,400 8 CIL.351,400	70-79 70-79 70-79 70-79	
 <p>AM-1013</p>	60002				
 <p>AM-1014</p>	41353 60007	FORD 35/M 400 FORD TRUCK LINCOLN MERCURY	8 CIL.351,400 8 CIL.351,400 8 CIL.351,400 8 CIL.351,400	70-79 70-79 70-79 70-79	
	BOSCH:68486				
 <p>AM-1015</p>	60002				
 <p>AM-1016</p>	60002				

FUEL PUMP

AMERICAN CAR SERIES

REFERENCE NO. OEM NUMBER	CAR & MODEL	ENG.	YEAR	TYPE & REMARKS
41253 6750	FORD,CROWN VICTORIA, LTD, THUNDERBIRD, GRANADA, FAIRMONT, MAVERICK, MUSTANG, LINCOLN, MARK SERIES III, TOWN CAR, CONTINENTAL, VERSALLES, GRAND MARQUIS COUGAR, MARQUIS MONARCH, COMET Y CMTAS. FORD RANCHERO, M/255, 302, 351(W) DE 4.2/5.0 Y 5.8 L(NO.VOCAR PE-609/05)	8 CIL.	76/86	
41248				
41246	FORD CHRYSLER			
42333 60045	FORD 429/600/700/800			
60144 61191 64014 42075				
41124				
42138	EN "V" BUICK CENTURY, SHYLARK, CELEBRITY, CITATION, OLDSMOBILE CUTLAS CIERA, OMEGA, PONTIAC 6000 M/173 DE 2.8 LTS. (NO.BOCAR PE-622/05) CENTURY 173	6 CIL	82/86	







FUEL PUMP

AMERICAN CAR SERIES

REFERENCE NO. OEM NUMBER	CAR & MODEL	ENG.	YEAR	TYPE & REMARKS
41380 41379				
42182	EN "V" CMTAS, CHEVROLET S-10/S-10 BLAZER, GMC, S-15/S-15 JIMMY, JEEP CHEROKEE, WAGONEER, COMANCHE, M/173 DE 2.8L	6 CIL	84/86	
42186	EN "V" CMTAS, CHEVROLET S-10/S-10 BLAZER, GMC, S-15/S-15 JIMMY, M/173 DE 2.8 LTS.	6 CIL	84/85	
41247	FORD CHRYSLER			
1139S				
42160	HUMMER V8-6.2L		1993	







FUEL PUMP

TOYOTA SERIES

	REFERENCE NO. OEM NUMBER	CAR & MODEL	ENG.	YEAR	TYPE & REMARKS
 T-1001	TP457-1 DW101 23100-31031 23100-39085 BCD2538/6	HILUX(RN)	12R 1600cc	72-74	FP80118
 T-1002	TP470 DW102 23100-24030 23100-29085	COROLLA(KE) PUBLICA(KP) (KP30.31.36.37.40.45.47) STARLET Km10 LIGHT-ACE(KM)	1200cc KE20 KE30 3K	75-79 73-80	
 T-1003	TP411-2 DW102-1 23100-29037-8 23100-24013	COROLLA(KE) PUBLICA(KP)	3K 1200cc	72-74	FP 80113 B/S:41649
 T-1004	TP476-1 DW103 23100-31041 23100-39095 23100-39096 BCD2539/6	COROLLA(RT)100.106.116 TOYO-ACE(RY) HILUX(RN) HI-ACE(RH)	12R 1600cc RH11	73-78 77-78	BCD:2539/6 FP 80120
 T-1005	TP 594 DW109 23100-339255/6-7 23100-31050	HIRACKS(RN) COROLLA(RT) HI-LUX TOYO-ACE(RY) HII-ACE(RM)	12R 1600cc RH20	78-	STEEL FP80130
 T-1006	TP605 DW110 23100-61050	LANDCRUISER(USA) HIRACES RN(FJ) CORONA(AT) HI-LUX TOYOTA-ACE(RY) HI-ACE(RM)	L/C FJ40 2F 1600CC	79-	STEEL
 T-1007 IN Φ10 OUT Φ8 R Φ6.5	TP 695/TP742 DW111 23100-61060	LANDCRUISER (FJ)#	2F 4300cc	83-84	STEEL FP80102

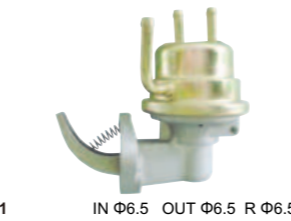



FUEL PUMP

TOYOTA SERIES

	REFERENCE NO. OEM NUMBER	CAR & MODEL	ENG.	YEAR	TYPE & REMARKS
 T-1008	TP 643 TP 765 DW112 23100-39335-6 23100-35020 23100-35030-1 DW112-1 23100-35040	CORONA CELICA(USA) HI-LUX 22R ALL(USA) CARINA HI-LUX	22R	80-	STEEL
 T-1009	TP 640-1 DW115-1 23100-39346 23100-37031 23100-37041	MARK II=CRESSIDA(RX) CELICA(RA)CORONA(RT) CALINA(RA)	21R 2000cc RX 60	81-94 80-82	STEEL
 T-1010	TP 702 DW115-2 23100-37060 23100-37061	CORONA(RA) MARK II=CRESSIDA(RX)	21R	84-	STEEL FP80106
 T-1011 IN Φ6.5 OUT Φ6.5 R Φ6.5	TP 673 DW116 DW407 23100-79025-7 23100-71020-1	MARK II=CRESSIDA(YX) HI-ACE(YH) HILUK(YN) DYNA(YN)	1Y,2Y 3Y. 2000cc YH50	83-	STEEL FP80137
 T-1012	TP 613 DW117 23100-13050 23100-19125/6 BCD2506/6	TOWN-ACE(KR) COROLLA 30(KE) STALET(KP) LIGHT-ACE(KP) CHARMANT	4K 1300cc KE 70	79- 81-83	STEEL FP80134
 T-1013	TP 712 DW121-2 23100-13100 23100-13111 23100-13110	LIGHT-ACE(KM)	5K-C 1500cc		
 T-1014	TP705 DW123 23100-161080	LANDCRUISER(FJ)	3F FJ 60	84-87	STEEL FP 80104





FUEL PUMP

TOYOTA SERIES

REFERENCE NO. OEM NUMBER	CAR & MODEL	ENG.	YEAR	TYPE & REMARKS	
 T-1015 IN Φ6.5 OUT Φ6.5	TP609 DW127 23100-29305/6~7 23100-26130	COROLLA(TE) CARINA(TA) CELICA(TA) CORONA(TT)	T.2T 1400- 1600cc	79-85	STEEL FP80132
	TP682 DW132 23100-19195 23100-15060	COROLLA(TE)80. CORONA(AT) 1300-1500cc	2A-L 2A-U 3A-L A180	83- 84-85	STEEL FP80101
 T-1017	TP 697 DW 153-1 23100-10020/1 23100-10030	5STARLET(EP) 1000-1300cc	IE-ALL_2E	84- 2PIPE	STEEL
	TP 775 DW153-2 23100-11080	COROLLA	2E EE902E		
 T-1018	TP 608 DW156 23100-13040 23100-13081~1 23100-19085/6	CHARMANT(A) STARLET(KP)	4KU	79-82	STEEL
	TP 776 DW164 23100-79075 23100-79076 23100-75010	LIGHT-ACE(KM)	1300cc		
 T-1019	TP 776 DW164 23100-79075 23100-79076 23100-75010	HI-ACE(R2H)	3F	90- 2200cc	STEEL
	TP 738 DW165 23100-15080~1	COROLLA(AE) CORONA(AT) CARINA(AA) 1500cc	5A-F	87	STEEL
 T-1020	TP 738 DW165 23100-15080~1	COROLLA(AE) CORONA(AT) CARINA(AA) 1500cc	5A-F	87	STEEL
	TP 738 DW165 23100-15080~1	COROLLA(AE) CORONA(AT) CARINA(AA) 1500cc	5A-F	87	STEEL







FUEL PUMP

TOYOTA SERIES

REFERENCE NO. OEM NUMBER	CAR & MODEL	ENG.	YEAR	TYPE & REMARKS	
 T-1022	TP 598 DW106 23100-44060 23100-49205-6	STOUT TOYO-ACE(RY) DYNA(RU)	5R 2000cc	79-85	FPS0131
	TP440 DW154 23100-31020	CORONA(RT) HIACE(RH) HILUX(RN) TOYO-ACE(RY)	2R	65-72	1600cc
 T-1023	TP615 DW118-1 23100-19105/6	CORONA(TT) MARK II(TX) COROLLA(TE) CELICA(TA) CARINA(TA) CHASER(TX)	12T-U 13T-U	79-83	1600-1800cc
	TP603 DW178 23100-19705 23100-15020	COROLLA(AE)	1500cc,3A-u	79-83	STEEL
 T-1024 IN Φ6.5 OUT Φ6.5 R Φ5	TP711 DW173 23100-13100-1	LIGHT-ACE(KM)	1500cc,5K-u	85	STEEL
	TP802 DW198 23100-66011 23100-69085 23100-69095	LANDCRUISER	1FZ	91	STEEL
 T-1025	TP 739 DW 145 23100-16040/1	COROLLA(AE)(USA)	4A-F 1600cc	87-	STEEL LER#40741 BIS:5026
	TP 739 DW 145 23100-16040/1	COROLLA(AE)(USA)	4A-F 1600cc	87-	STEEL LER#40741 BIS:5026

FUEL PUMP

MAZDA SERIES



REFERENCE NO. OEM NUMBER	CAR & MODEL	ENG.	YEAR	TYPE & REMARKS
 M-1004	P591/NP591 BCD1990/5 DW303 0370-13-350 8036-13-350 8914-13-350 8042-13-350	MAZDA 6LC 323 FAMILIA	PC TC 1300- 1500cc	71- STEEL
 M-1005	P746 DW325 B319-13-350 B320-13-350	MAZDA323(EXP) FAMILIA	B6 1600cc	87- STEEL
 M-1006	DW322 FE 85-23-350A FE 85-13-3550	(FE)B2000,B2200	1998cc/ 2.0L 2184/ 2.2L	86-88 STEEL
 M-1007	P690 P28459 P904 DW312-1 PE85-13-350			
 M-1008	P740 DW312-2 F8B1-13-350			
 M-1009	P781 DW332 B336-13-350 B368-13-350			
 M-1010	P729 DW582 DW321 B303-13-350 B303-13-350B B303-13-350/C E82B-9350A	MAZDA 121(EXP)(USA) FESTIVA(FORD) PRIDE(KIA),PRIDE VAN	B3 1300cc	87- STEEL TYPE KIA.AL-TYPE

FUEL PUMP

BENZ SERIES

REFERENCE NO. OEM NUMBER	CAR & MODEL	ENG.	YEAR	TYPE & REMARKS
 M-1011	BCD 1990/5 0370-13-350 247120 271056,353 461-382 7.21632.50 8036-13-350 8042-13-350 8460 8914-13-350 8914-14-350	Mazda 323 323 323 323 (usa) 323 Van, GLC Vaagon (Usa) 323, 818 808, 818 E 1400 Commercial (Usa) Familia GLC Mizer (Usa)	FA4 PS 1000 1.0 Lt FA4 TS 1300 1.3 Lt Fa4 US 1400 1.4 Lt 1300,1415 1.3-1.4 Lt 1.5 Lt 1.4-1.5Lt LSTM 1300 1.3 Lt PC, TC1.3-1.5Lt TC, UC1.3-1.4Lt 1300(TC)1.3Lt	1976-1980 1976-1980 1976-1980 02.77-1985 08.73-1985 1981-... 1974-... 1975-1978 03.84-... 1976-... 1977-1980 1976-1977

FUEL PUMP BENZ SERIES







REFERENCE NO. OEM NUMBER	CAR & MODEL	ENG.	YEAR	TYPE & REMARKS
 B-1001	B05 72087551	BENZ		
 B-1002	B04 72087450	BENZ		
 B-1003	720 804 539-082	BENZ		

FUEL PUMP SUZUKI SERIES



REFERENCE NO. OEM NUMBER	CAR & MODEL	ENG.	YEAR	TYPE & REMARKS
 S-1001	15100-77100 DW453 BCD2701	SUZUKI VAN PICK UP	ST308V ST308R	STEEL

FUEL PUMP

SUZUKI SERIES

	REFERENCE NO. OEM NUMBER	CAR & MODEL	ENG.	YEAR	TYPE & REMARKS
 S-1002	DW 457-1 15100-79102 MDF 72-2 15100-78400 15100-78410 15100-78420	ST90 CARRY	4G62 4G1	85-	HEXAGON TYPE
 S-1003	12300-73811 DW458 15100-83010	SUZUKI			
 S-1004	15100-80000 DW 460 MDF 72-1 15100-73000 15100-73003 15100-8000-K 4-720017	MDF72-4 DW464 BCD2583	SUZUKI JEEP FRONTE(SS40) CARRY VAN(ST40)	SJ410 F5A 543CC	82-86 HEXAAL-M1KUNI TYPE
 S-1005 IN Ø6.5 OUT Ø6.5 R Ø6.5	DW459 15100-82010 A9134 DW568 RST-5210 BCD2635	CHEVROLET SPRINT/SWIET SUZUKI Sa310 993cc	GL,GC GL GL3A SA310	85-86	STEEL
 S-1006 IN Ø6.5 OUT Ø6.5	945811766 15100A78B00-000	SUZUKI			
 S-1007 IN Ø8 OUT Ø6.5	15100-78140 50A00 DW455	SUZUKI MEHREN			
 S-1008 IN Dia.8 OUT Dia.6	BCD 2583/1 15000-B0000 151000-80000 151000-E80000 247111 3850 80000-32M AH-028 FPM-047 M DF62-10 POC 652	Holden Suzuki-Santana	Barina BM,ML SJ 410 Swift GL,GC	Suzuki-Santana G13A(1298 CC) Suzuki-Santana G10(993 cc) Suzuki-Santana G13A(1298 cc)(USA)	1985-1988 1982-1990 1985-1988

HONDA SERIES

	REFERENCE NO. OEM NUMBER	CAR & MODEL	ENG.	YEAR	TYPE & REMARKS
 H-1001	BCD2511/6 HP-445 DW471 16700-634-315 16700-634-005 16700-634-0151 16700-634-673	HONDA CIVIC SB11	EB EB-1 EB-2 CB-1 EN	72-77	NIKKI56-501
 H-1002	HP-753 16700-PE0003 DW472	CIVIC(USA) BALLADE 13/1500	EV EW 1300CC 1500CC	84-	STEEL FP 47102

OIL-WATER SEPARATOR SERIES

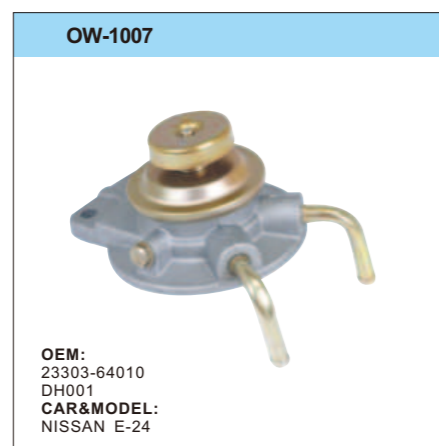
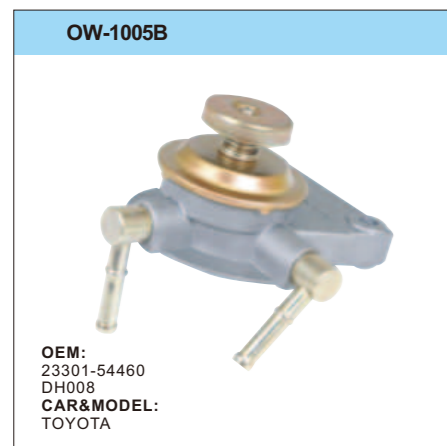

OIL-WATER SEPARATOR SERIES

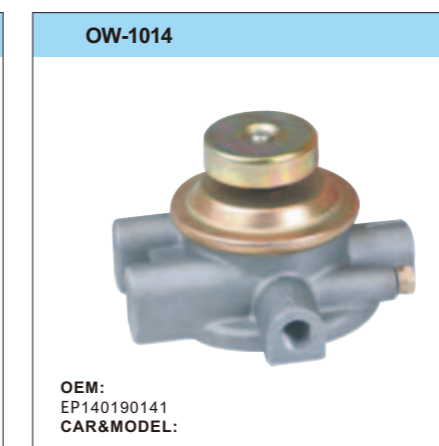
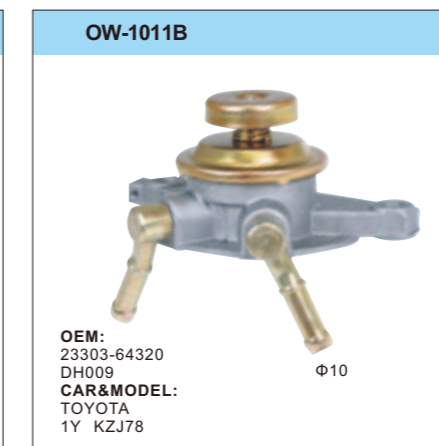
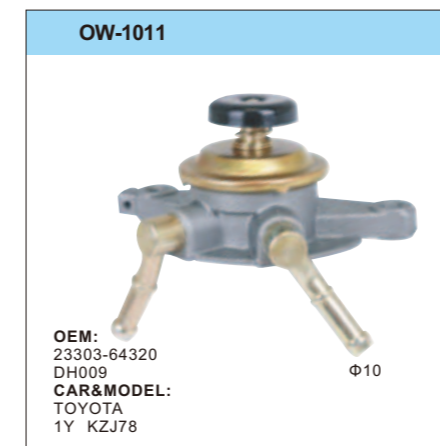
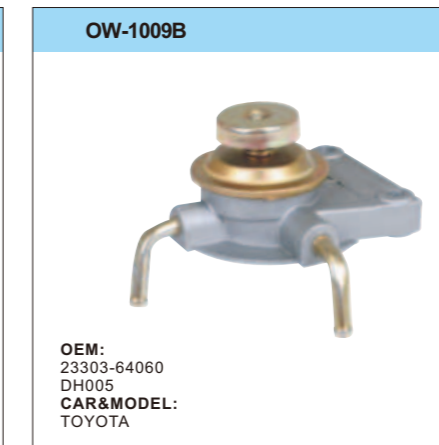







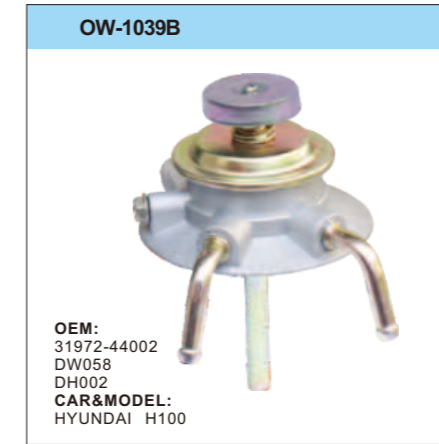
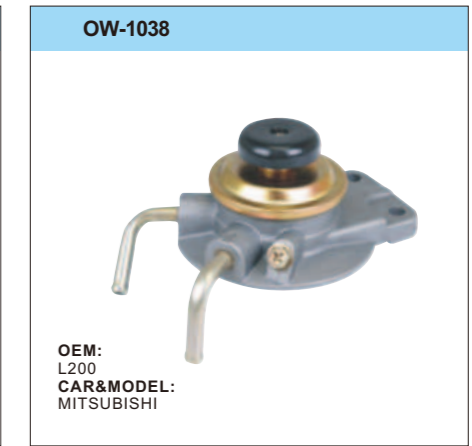
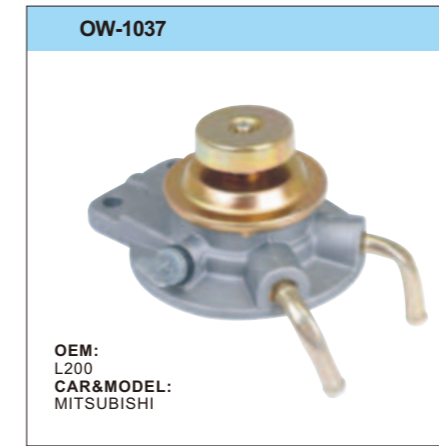
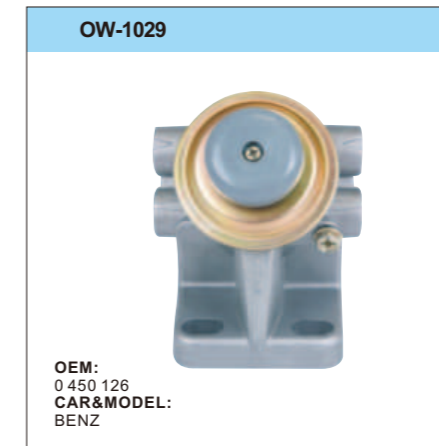



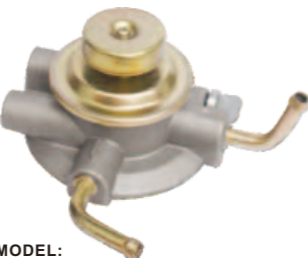

OIL-WATER SEPARATOR SERIES



OIL-WATER SEPARATOR SERIES

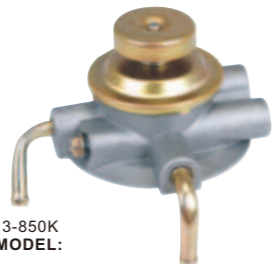







OIL-WATER SEPARATOR SERIES

<p>OW-1040A</p>  <p>OEM: 31970-44500 31972-44100 CAR&MODEL: HYUNDAI</p>	<p>OW-1041</p>  <p>OEM: CAR&MODEL: KIA</p>	<p>OW-1042</p>  <p>OEM: CAR&MODEL: MF001</p>
<p>OW-1043</p>  <p>OEM: CAR&MODEL: KIA</p>	<p>OW-1044</p>  <p>OEM: 31945-44000 CAR&MODEL: MITSUBISHI</p>	<p>OW-1044A</p>  <p>OEM: 31945-44000 CAR&MODEL: MITSUBISHI</p>
<p>OW-1045</p>  <p>OEM: ME-035672 CAR&MODEL:</p>	<p>OW-1046</p>  <p>OEM: ME-996065 CAR&MODEL:</p>	<p>OW-1047</p>  <p>OEM: TFR CAR&MODEL:</p>
<p>OW-1047A</p>  <p>OEM: TFR CAR&MODEL:</p>	<p>OW-1048</p>  <p>OEM: K759-13-850K CAR&MODEL: KIA</p>	<p>OW-1048A</p>  <p>OEM: K759-13-850 DH024 CAR&MODEL: KIA</p>
<p>OW-1049</p>  <p>OEM: K672-13-850 DH020 CAR&MODEL: KIA</p>	<p>OW-1049A</p>  <p>OEM: K672-13-850 DH020 CAR&MODEL: KIA</p>	<p>OW-1050</p>  <p>OEM: CAR&MODEL: KIA</p>



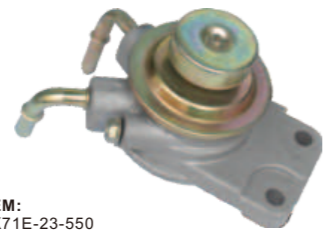

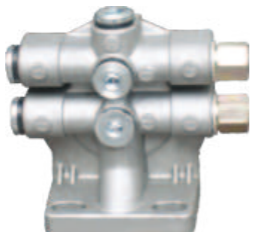





OIL-WATER SEPARATOR SERIES

<p>OW-1051</p>  <p>OEM: 4-47300-2150 TFR-1 CAR&MODEL: ISUZU</p>	<p>OW-1051A</p>  <p>OEM: 4-47300-2150 TFR-1 CAR&MODEL: ISUZU</p>	<p>OW-1052</p>  <p>OEM: CAR&MODEL: MF003</p>
<p>OW-1053</p>  <p>OEM: 8-94154-754-0 CAR&MODEL: TFR-2</p>	<p>OW-1053A</p>  <p>OEM: 8-94154-754-0 CAR&MODEL: TFR-2</p>	<p>OW-1054</p>  <p>OEM: 8-9708184-2 CAR&MODEL: KIA</p>
<p>OW-1055</p>  <p>OEM: K672-13-810 CAR&MODEL: KIA</p>	<p>OW-1057</p>  <p>OEM: 16401-VC10C CAR&MODEL: NISSAN ZD30</p>	<p>OW-1058</p>  <p>OEM: 23300-23060-23071 CAR&MODEL: NISSAN</p>
<p>OW-1059</p>  <p>OEM: 23301-17130 DH009-1 CAR&MODEL: TOYOTA</p> <p>8mm</p>	<p>OW-1060</p>  <p>OEM: 23301-17130 DH009-1 CAR&MODEL: TOYOTA</p> <p>Φ8</p>	<p>OW-1061</p>  <p>OEM: CAR&MODEL: NISSAN</p>
<p>OW-1062</p>  <p>OEM: 23380-17430 CAR&MODEL: TOYOTA</p>	<p>OW-1063</p>  <p>OEM: 23380-17410 CAR&MODEL: TOYOTA</p>	<p>OW-1064</p>  <p>OEM: OK631-23-550 CAR&MODEL: KIA</p>

OIL-WATER SEPARATOR SERIES

<p>OW-1065</p>  <p>OEM: 23380-5B150 CAR&MODEL: TOYOTA</p>	<p>OW-1066</p>  <p>OEM: CAR&MODEL:</p>	<p>OW-1067</p>  <p>OEM: 23301-17030 CAR&MODEL: HZJ75/78</p>
<p>OW-1068</p>  <p>OEM: OK647-23-550 CAR&MODEL: KIA</p>	<p>OW-1069</p>  <p>OEM: OK71E-23-550 CAR&MODEL: KIA</p>	<p>OW-1069A</p>  <p>OEM: OK71E-23-550 CAR&MODEL: KIA</p>
<p>OW-1070</p>  <p>OEM: R90 000 477 13 02 ; 058 250 10 ; 1000167423 10101998;11110683;4255 4067 CAR&MODEL: MERCEDES-BENZ;VOLVO;IVECO;MAN</p>	<p>OW-1071</p> 	
<p>SS-1001</p>  <p>OEM: K670-13-810 K672-13-810 CAR&MODEL: KIA</p>	<p>SS-1002</p>  <p>OEM: CAR&MODEL: KIA; TOYOTA</p>	<p>SS-1003</p>  <p>OEM: MB348132 CAR&MODEL: MITSUBISHI</p>
<p>ARSS-1004</p>  <p>OEM: 23303-64020 CAR&MODEL: TOYOTA</p>	<p>ARSS-1005</p>  <p>OEM: CAR&MODEL: ISUZU</p>	<p>ARPJ-1001</p>  <p>OEM: 104498M1 995260 12079G 4797320-C CAR&MODEL: MASSEY FERGUSON</p>

ELECTRONIC FUEL PUMP SERIES

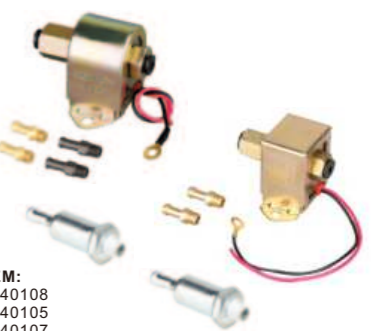
<p>EP-1001</p>  <p>OEM: UC-J3 DWI 0913 16700-689-045/025 16700-689-0051/015 16700-PB1-003 CAR&MODEL: HONDA</p>	<p>EP-1002</p>  <p>OEM: UC-J7 DWI 0915 16700-PC1-003 16700-PC1-013 CAR&MODEL: HONDA</p>	<p>EP-1003</p>  <p>OEM: UC-J7B DWI 0955 16700-PC6-003 CAR&MODEL: HONDA PRELUDE</p>
<p>EP-1004</p>  <p>OEM: UC-J8 DWI 0915 16700-PD2-003 CAR&MODEL: HONDA</p>	<p>EP-1005</p>  <p>OEM: UC-J10H DWI 9052 15100-77500 CAR&MODEL: SUZUKI</p>	<p>EP-1006</p>  <p>OEM: UC-10J CAR&MODEL: SUZUKI</p>
<p>EP-1007</p>  <p>OEM: UC-J12A DWI 0956 B697-13-350 N249-13-400A/B 0222-13-350 CAR&MODEL: MAZDA</p>	<p>EP-1008</p>  <p>OEM: UC-V4 DWI 0910 15100-85501 CAR&MODEL: SUZUKI</p>	<p>EP-1009</p>  <p>OEM: UC-V6B DWI D911 15100-77300 CAR&MODEL: SUZUKI CARRY</p>
<p>EP-1010</p>  <p>OEM: UC-N DWI 0953 64200-20090 6420-20050 CAR&MODEL: SUBARU</p>	<p>EP-1011</p>  <p>OEM: UC-N5 DWI 0954 74200-21000 CAR&MODEL: SUBARU</p>	<p>EP-1012</p>  <p>OEM: EP40108 EP40105 EP40107 CAR&MODEL: UNIVERSAL</p>

ELECTRONIC FUEL PUMP SERIES

ELECTRONIC FUEL PUMP SERIES

EP-1013



OEM:
E8090
CAR&MODEL:
UNIVERSAL

EP-1014



OEM:
E8153
CAR&MODEL:
UNIVERSAL

EP-1015



OEM:
E8012S
CAR&MODEL:
UNIVERSAL

EP-1016



OEM:
EP-500-0
DW317
8118-13-350
CAR&MODEL:
MAZDA929

EP-1017

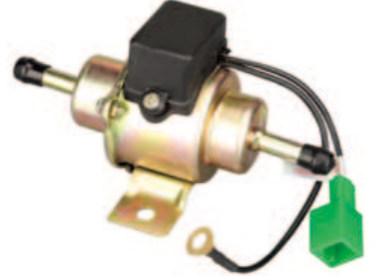

OEM:
EP-500-0
CAR&MODEL:
MAZDA

EP-1018



OEM:
EP-501-0
DAEWHA:1942-13-350
1943-13-350A
8118-13-350
AIRTEX:2014
CAR&MODEL:
MAZDA

EP-1019



OEM:
EP-502-0
8788-13-350
D97Z-9350A
CAR&MODEL:
MAZDA,FORD

EP-1020

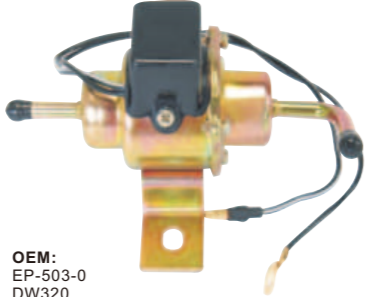

OEM:
EP-503-0
DW320
0453-13-350
CAR&MODEL:
MAZDA929

EP-1021



OEM:
EP-504-0
AIRTEX:E8304
DAEWHA:DW307
8072-13-350B
CAR&MODEL:
MAZDA

EP-1022



OEM:
EP-505-0
DW318
8173-13-350
CAR&MODEL:
MAZDA626

EP-1023



OEM:
EP-506-0
DAEWHA:DW331
8116-13-350A
CAR&MODEL:
MAZDA

EP-1024



OEM:
EP-600-0
DW482
8420-21060
7420-21100
CAR&MODEL:
PICK UP,SUBARU

EP-1025



OEM:
EP-601-0
DAEWHA:DW481
7420-21050
7420-21060
AIRTEX:E8058
AC DELCO:EP150
CAR&MODEL:
MAZDA

EP-1026



OEM:
EP-602-0
DW484
7420-GA140
42024-GA140
42021-GA140
CAR&MODEL:
SUBARU

EP-1027



OEM:
EP-603-0
DW483
7420-21101
CAR&MODEL:
SUBARU

EP-1028

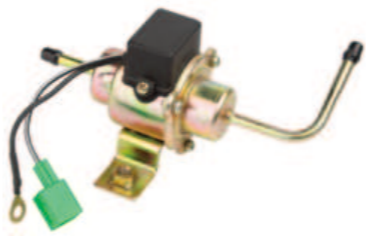

OEM:
EP-700
056200-0510
056200-0570
CAR&MODEL:

EP-1029



OEM:
DP700-0
DW426
23100-87575-000
05600-0570
CAR&MODEL:
DAIHATSU

EP-1030



OEM:
EP7223
8173-400B
CAR&MODEL:
MAZDA

EP-1031

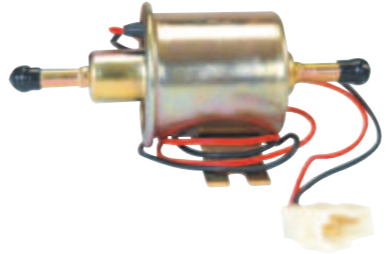

OEM:
HEP-02A
CAR&MODEL:
HONDA

EP-1032



OEM:
HEP-02
CAR&MODEL:

EP-1033



OEM:
23100-87516
CAR&MODEL:
DAIHATSU

EP-1034



OEM:
23100-87515-008
056200-0570
CAR&MODEL:
DAIHATSU

EP-1035

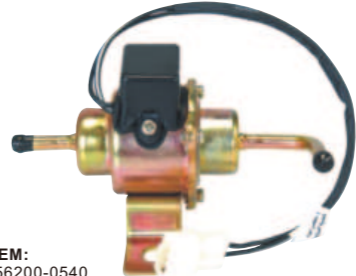

OEM:
056200-0540
DW428
23100-87511-000
CAR&MODEL:
DAIHATSU

EP-1036



OEM:
056200-0582
DW427
23100-87516-000
CAR&MODEL:

ELECTRONIC FUEL PUMP SERIES

EP-1037



OEM:
47608E
480532E
17020-10w00
E8318
17010-06w01
CAR&MODEL:
NISSAN SUZUKI

EP-1038



OEM:
HEP02
UC-V4V
DW0910
15100-85501
CAR&MODEL:
SUZUKI

EP-1039



OEM:
HX-3030;
3629674;
3797522;
4299544
CAR&MODEL:
UNIVERSAL

EP-1040



OEM:
129612-52100
CAR&MODEL:

EP-1041



OEM:
CAR&MODEL:
MAZDA

EP-1042



OEM:
CAR&MODEL:

EP-1043



OEM:
CAR&MODEL:
MITSUBISHI-3H6/V31/V33;SUZUKI

EP-1044



OEM:
129612-52100
CAR&MODEL:

EP-1045



OEM:
UC-V3
16700-PD2-003
CAR&MODEL:
SUBARU

NOTES

