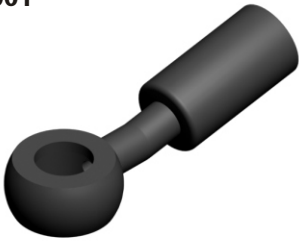
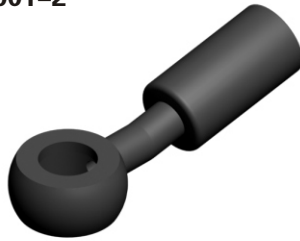
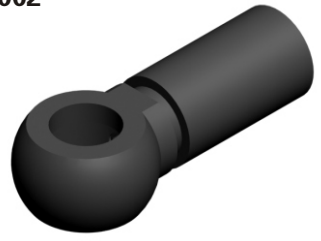

**BB001**

O.D.	Hole	Length	Bend
Φ20	Φ10	58	20°

**BB001-2**

O.D.	Hole	Length	Bend
Φ20	Φ10	60	15°

**BB002**

O.D.	Hole	Length	Bend
Φ20	Φ12	46	

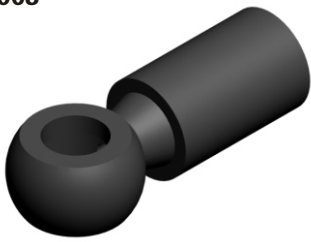
**BB003**

O.D.	Hole	Length	Bend
Φ18	Φ10	50	

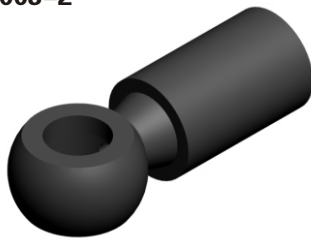
**BB003-2**

O.D.	Hole	Length	Bend
Φ17	Φ10	50	

**BB004**

O.D.	Hole	Length	Bend
Φ19	Φ10	48	

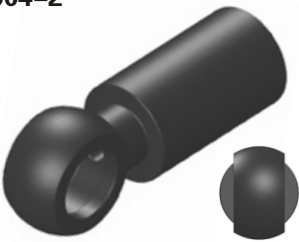
**BB004-2**

O.D.	Hole	Length	Bend
Φ19	Φ10	49	

**BB005**

O.D.	Hole	Length	Bend
Φ19	Φ10	44	

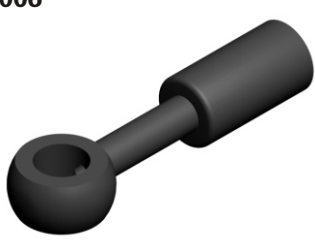
**BB006**

O.D.	Hole	Length	Bend
Φ17	Φ10	50	

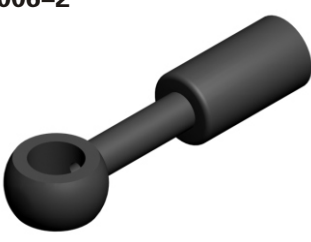
**BB006-2**

O.D.	Hole	Length	Bend
Φ18	Φ10	50	

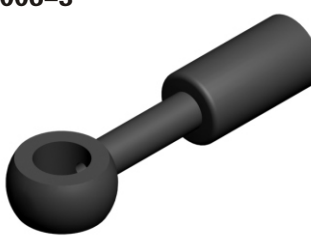
**BB006-3**

O.D.	Hole	Length	Bend
Φ19	Φ10	57	

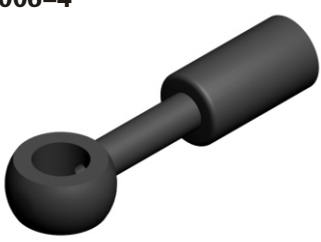
**BB006-4**

O.D.	Hole	Length	Bend
Φ19	Φ10	48.5	

**BB006-5**

O.D.	Hole	Length	Bend
Φ18	Φ11	49	

**BB006-6**

O.D.	Hole	Length	Bend
Φ19	Φ11	61	

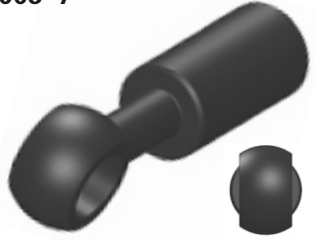
**BB006-7**

O.D.	Hole	Length	Bend
Φ17	Φ10	52	

**BB006-8**

O.D.	Hole	Length	Bend
Φ17	Φ10	51	

**BB007**

O.D.	Hole	Length	Bend
Φ20	Φ10	55	

**BB007-2**

O.D.	Hole	Length	Bend
Φ21	Φ12	54	

**BB007-3**

O.D.	Hole	Length	Bend
Φ18	Φ11	44	

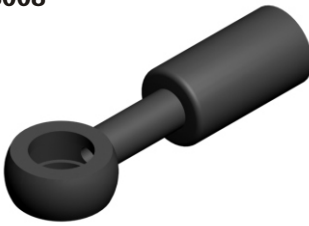
**BB008**

O.D.	Hole	Length	Bend
Φ17	Φ10	60	

**BB008-2**

O.D.	Hole	Length	Bend
Φ17	Φ10	55.6	

**BB008-3**

O.D.	Hole	Length	Bend
Φ17	Φ10	45	

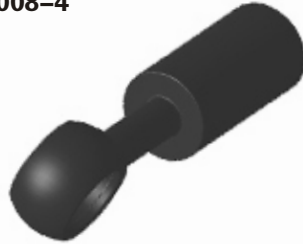
**BB008-4**

O.D.	Hole	Length	Bend
Φ17	Φ11	59	

**BB008-5**

O.D.	Hole	Length	Bend
Φ17	Φ10	57	

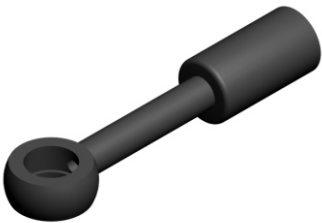
**BB009**

O.D.	Hole	Length	Bend
Φ17	Φ10	75	

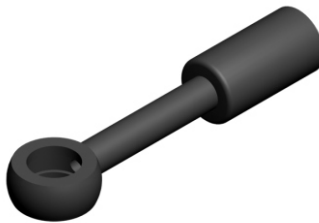
**BB009-2**

O.D.	Hole	Length	Bend
Φ17	Φ10	75	

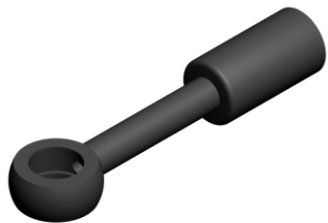
**BB009-3**

O.D.	Hole	Length	Bend
Φ18	Φ10	58	

**BB009-4**

O.D.	Hole	Length	Bend
Φ18	Φ10	68	

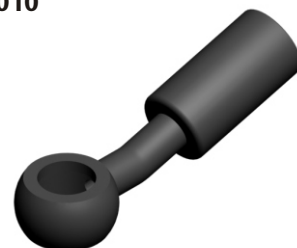
**BB010**

O.D.	Hole	Length	Bend
Φ17	Φ10	58	15°

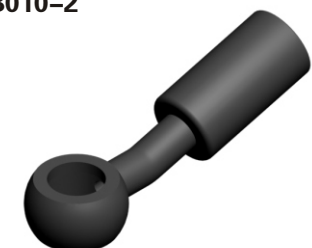
**BB010-2**

O.D.	Hole	Length	Bend
Φ18	Φ10	58	15°

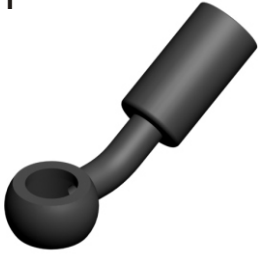
**BB011**

O.D.	Hole	Length	Bend
Φ18	Φ10	62	30°

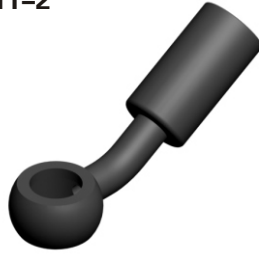
**BB011-2**

O.D.	Hole	Length	Bend
Φ17	Φ10	62	30°

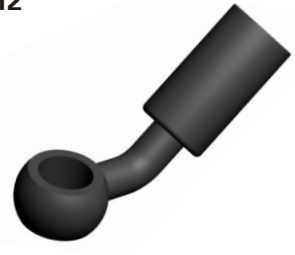
**BB012**

O.D.	Hole	Length	Bend
Φ17	Φ10	56	45°

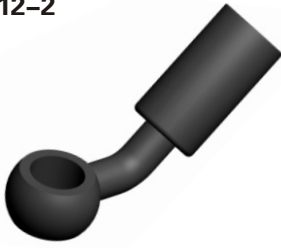
**BB012-2**

O.D.	Hole	Length	Bend
Φ17	Φ10	60	23°

**BB012-3**

O.D.	Hole	Length	Bend
Φ17	Φ10		45°

**BB013**

O.D.	Hole	Length	Bend
Φ17	Φ10	38	75°

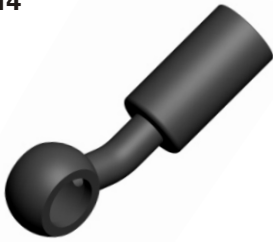
**BB014**

O.D.	Hole	Length	Bend
Φ17	Φ10	50	30°

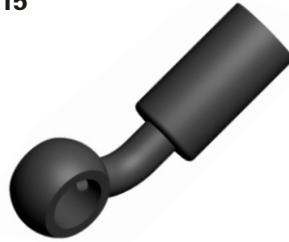
**BB015**

O.D.	Hole	Length	Bend
Φ17	Φ10	52	45°

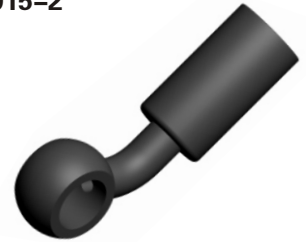
**BB015-2**

O.D.	Hole	Length	Bend
Φ17	Φ10	52	45°

**BB016**

O.D.	Hole	Length	Bend
Φ17	Φ10	45	90°

**BB017**

O.D.	Hole	Length	Bend
Φ17	Φ10	43	30°

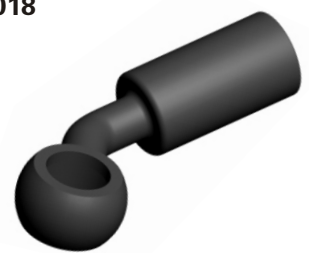
**BB018**

O.D.	Hole	Length	Bend
Φ17	Φ10	50	45°

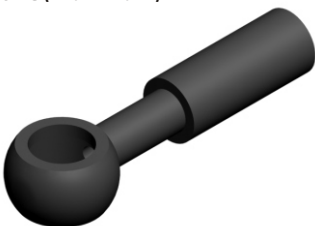
**BB019(Aluminum)**

O.D.	Hole	Length	Bend
Φ17	Φ10	55	

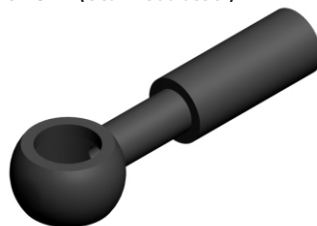
**BB019-2(Stainless steel)**

O.D.	Hole	Length	Bend
Φ17	Φ10	55	

**BB020**

O.D.	Hole	Length	Bend
Φ20	Φ11	51	

**BB020-2**

O.D.	Hole	Length	Bend
Φ17	Φ10	58	

**BB021**

O.D.	Hole	Length	Bend
Φ17	Φ10	50	15°

**BB022**

O.D.	Hole	Length	Bend
Φ17	Φ10	50	30°

**BB023**

O.D.	Hole	Length	Bend
Φ17	Φ10	80	45°

**BB024**

O.D.	Hole	Length	Bend
Φ17	Φ10	43	90°

**BB024-2**

O.D.	Hole	Length	Bend
Φ17	Φ10	46	120°

**BB025**

O.D.	Hole	Length	Bend
Φ17	Φ10	35	

**BB025B**

O.D.	Hole	Length	Bend
Φ17	Φ10		70°

**BB026**

O.D.	Hole	Length	Bend
Φ17	Φ10	49	30°

**BB027**

O.D.	Hole	Length	Bend
Φ17	Φ10	52	15°

**BB028**

O.D.	Hole	Length	Bend
Φ17	Φ10	55	90°

**BB029**

O.D.	Hole	Length	Bend
Φ18	Φ10	59	15°

**BB029-2**

O.D.	Hole	Length	Bend
Φ19.5	Φ10	55	10°

**BB029-3**

O.D.	Hole	Length	Bend
Φ19.5	Φ10	55	20°

**BB030**

O.D.	Hole	Length	Bend
Φ17	Φ10	123	

**BB031**

O.D.	Hole	Length	Bend
Φ18	Φ11	60.5	

**BB032**

O.D.	Hole	Length	Bend
Φ17	Φ10	57	

**BB033**

O.D.	Hole	Length	Bend
Φ17	Φ10	55	30°

**BB033-2**

O.D.	Hole	Length	Bend
Φ17	Φ10		40°

**BB034**

O.D.	Hole	Length	Bend
Φ17	Φ10	55	60°

**BB034B**

O.D.	Hole	Length	Bend
Φ17	Φ10	56	60°

**BB035**

O.D.	Hole	Length	Bend
Φ17	Φ10	57	24°

**BB035-2**

O.D.	Hole	Length	Bend
Φ17	Φ10	60	13°

**BB036**

O.D.	Hole	Length	Bend
Φ18	Φ10	145	20°

**BB037**

O.D.	Hole	Length	Bend
Φ20.5	Φ10	51.3	

**BB038**

O.D.	Hole	Length	Bend
Φ20	Φ10	57	15°

**BB039**

O.D.	Hole	Length	Bend
Φ21	Φ12	58	

**BB040**

O.D.	Hole	Length	Bend
Φ17	Φ10	49	

**BB041**

O.D.	Hole	Length	Bend
Φ20	Φ10		15°

**BB042**

O.D.	Hole	Length	Bend
Φ17	Φ10		90°

**BB043**

O.D.	Hole	Length	Bend
Φ17	Φ10		70°

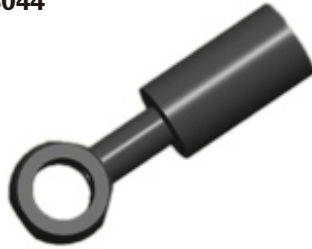
**BB044**

O.D.	Hole	Length	Bend
Φ17	Φ10	54	

**BB045**

O.D.	Hole	Length	Bend
Φ17	Φ10		50°

**BB045B**

O.D.	Hole	Length	Bend
Φ17	Φ10		50°

**BB046**

O.D.	Hole	Length	Bend
Φ17	Φ10		20°

**BB047**

O.D.	Hole	Length	Bend
Φ17	Φ10		20°

**BB048**

O.D.	Hole	Length	Bend
Φ17	Φ10	50	

**BB049**

O.D.	Hole	Length	Bend
Φ17	Φ10	68	

**BB050**

O.D.	Hole	Length	Bend
Φ20	Φ10		40°

**BB050B**

O.D.	Hole	Length	Bend
Φ20	Φ10		40°

**BC001**

O.D.	Hole	Length	Bend
Φ19	Φ10	55	

**BC002**

O.D.	Hole	Length	Bend
Φ17	Φ10	55	

**BC002-2**

O.D.	Hole	Length	Bend
Φ18	Φ10	63	

**BC002-3**

O.D.	Hole	Length	Bend
Φ19	Φ10	52	

**BC002-4**

O.D.	Hole	Length	Bend
Φ19	Φ10	52	

**BC003**

O.D.	Hole	Length	Bend
Φ17	Φ10	100	

**BC003-2**

O.D.	Hole	Length	Bend
Φ17	Φ10	70	

**BC003-3**

O.D.	Hole	Length	Bend
Φ17	Φ10		60°

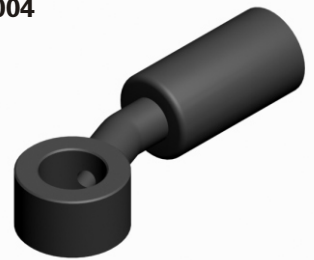
**BC004**

O.D.	Hole	Length	Bend
Φ17	Φ10	53	15°

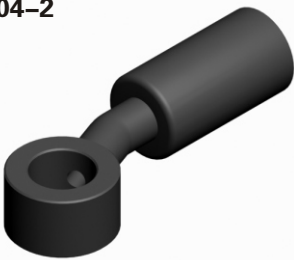
**BC004-2**

O.D.	Hole	Length	Bend
Φ18	Φ10	53	15°

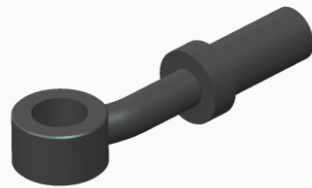
**BC004-3**

O.D.	Hole	Length	Bend
Φ17	Φ10	62	15°

**BC005**

O.D.	Hole	Length	Bend
Φ17	Φ10	40	60°

**BC005-2**

O.D.	Hole	Length	Bend
Φ17	Φ10	40	75°

**BC005-3**

O.D.	Hole	Length	Bend
Φ17	Φ10	74	

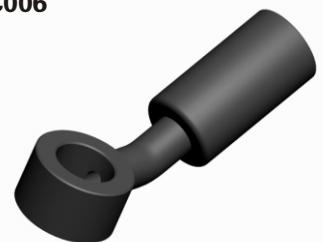
**BC006**

O.D.	Hole	Length	Bend
Φ17	Φ10	58	30°

**BC006-2**

O.D.	Hole	Length	Bend
Φ17	Φ10		20°

**BC006-3**

O.D.	Hole	Length	Bend
Φ17	Φ10		15°

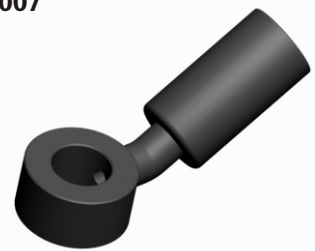
**BC007**

O.D.	Hole	Length	Bend
Φ19	Φ10	53	30°

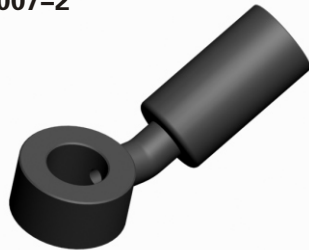
**BC007-2**

O.D.	Hole	Length	Bend
Φ17	Φ10	53	30°

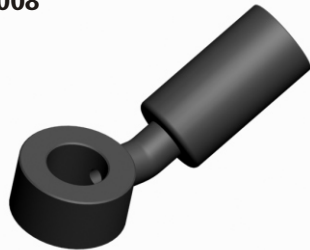
**BC008**

O.D.	Hole	Length	Bend
Φ17	Φ10	58	10°

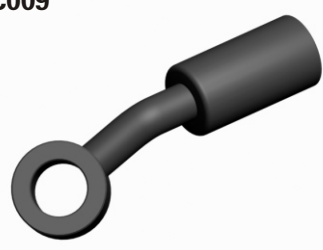
**BC009**

O.D.	Hole	Length	Bend
Φ17	Φ10	60	

**BC009B**

O.D.	Hole	Length	Bend
Φ17	Φ10		

**BC010**

O.D.	Hole	Length	Bend
Φ25	Φ10	85	

**BC010B**

O.D.	Hole	Length	Bend
Φ25	Φ10	85	

**BC011**

O.D.	Hole	Length	Bend
Φ21	Φ10	120	

**BC011B**

O.D.	Hole	Length	Bend
Φ21	Φ10	120	

**BC012**

O.D.	Hole	Length	Bend
Φ29	Φ10	190	

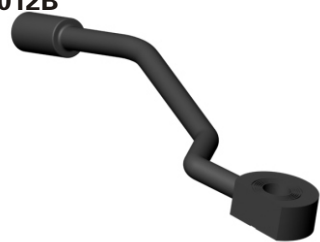
**BC012B**

O.D.	Hole	Length	Bend
Φ29	Φ10	190	

**BC013**

O.D.	Hole	Length	Bend
Φ29	Φ10	206	

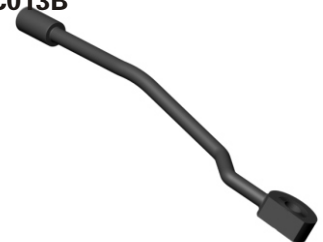
**BC013B**

O.D.	Hole	Length	Bend
Φ29	Φ10	206	



**BC014**

O.D.	Hole	Length	Bend
Φ29	Φ10	168	

**BC014B**

O.D.	Hole	Length	Bend
Φ29	Φ10	168	

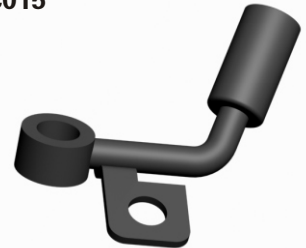
**BC015**

O.D.	Hole	Length	Bend
Φ17	Φ10	57	

**BC015B**

O.D.	Hole	Length	Bend
Φ17	Φ10	57	

**BC016**

O.D.	Hole	Length	Bend
Φ20	Φ10	100	

**BC017**

O.D.	Hole	Length	Bend
Φ17	Φ10	118	

**BC018**

O.D.	Hole	Length	Bend
Φ18	Φ10	135	

**BC019**

O.D.	Hole	Length	Bend
Φ17	Φ10	66.5	

**BC019B**

O.D.	Hole	Length	Bend
Φ17	Φ10	66.5	

**BC020**

O.D.	Hole	Length	Bend
Φ26	Φ11	51	

**BC020B**

O.D.	Hole	Length	Bend
Φ26	Φ11	51	

**BC021**

O.D.	Hole	Length	Bend
Φ17	Φ10		

**BC021B**

O.D.	Hole	Length	Bend
Φ17	Φ10		

**BC022**

O.D.	Hole	Length	Bend
Φ17	Φ10		

**BC022B**

O.D.	Hole	Length	Bend
Φ17	Φ10		

**BC023**



O.D.	Hole	Length	Bend
Φ17	Φ10		35°

**BC024**



O.D.	Hole	Length	Bend
Φ17	Φ10		35°

**BC025**



O.D.	Hole	Length	Bend
Φ19	Φ12		

**BC025B**



O.D.	Hole	Length	Bend
Φ19	Φ12		

**BC026**



O.D.	Hole	Length	Bend
Φ18	Φ10		

**BC026B**



O.D.	Hole	Length	Bend
Φ18	Φ10		

**BC027**



O.D.	Hole	Length	Bend
Φ17	Φ10		90°

**BC028**



O.D.	Hole	Length	Bend
Φ19	Φ10		

**BC028B**



O.D.	Hole	Length	Bend
Φ19	Φ10		

**BC029**



O.D.	Hole	Length	Bend
Φ17	Φ10		30°

**BC030**



O.D.	Hole	Length	Bend
Φ17	Φ10		140°

**BF001**

O.D.	Hole	Length	Bend
Φ17	Φ10	48	

**BF002**

O.D.	Hole	Length	Bend
Φ17	Φ10	48	

**BF002-2**

O.D.	Hole	Length	Bend
Φ17	Φ10	57	

**BF003**

O.D.	Hole	Length	Bend
Φ18	Φ10	50	

**BF004**

O.D.	Hole	Length	Bend
Φ18	Φ10	50	

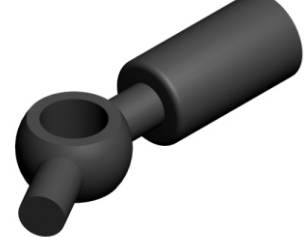
**BF004-2**

O.D.	Hole	Length	Bend
Φ17	Φ10	50	

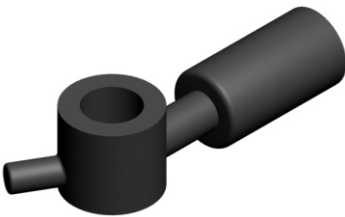
**BF005**

O.D.	Hole	Length	Bend
Φ17	Φ10	58	

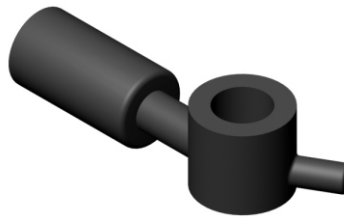
**BF005B**

O.D.	Hole	Length	Bend
Φ17	Φ10	58	

**BF006**

O.D.	Hole	Length	Bend
Φ18	Φ10	60	

**BF006B**

O.D.	Hole	Length	Bend
Φ18	Φ10	60	

**BF007**

O.D.	Hole	Length	Bend
Φ17	Φ10	64	40°

**BF008**

O.D.	Hole	Length	Bend
Φ17	Φ10	55	30°

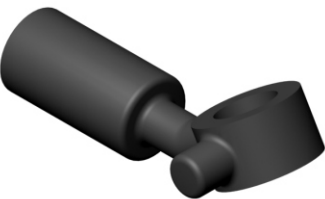
**BF008B**

O.D.	Hole	Length	Bend
Φ17	Φ10	55	30°

**BF008-2**

O.D.	Hole	Length	Bend
Φ17	Φ10	55	30°

**BF008-2B**

O.D.	Hole	Length	Bend
Φ17	Φ10	55	30°

**BF008-3**

O.D.	Hole	Length	Bend
Φ17	Φ10		20°

**BF008-3B**

O.D.	Hole	Length	Bend
Φ17	Φ10		20°

**BF008-4**

O.D.	Hole	Length	Bend
Φ17	Φ10		30°

**BF008-4B**

O.D.	Hole	Length	Bend
Φ17	Φ10		30°

**BF009**

O.D.	Hole	Length	Bend
Φ17	Φ10		30°

**BF010**

O.D.	Hole	Length	Bend
Φ19	Φ10	53	60°

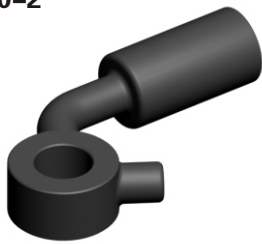
**BF010-2**

O.D.	Hole	Length	Bend
Φ17	Φ10	53	60°

**BF010-3**

O.D.	Hole	Length	Bend
Φ17	Φ10		120°

**BF010-4**

O.D.	Hole	Length	Bend
Φ17	Φ10		65°

**BF011**

O.D.	Hole	Length	Bend
Φ17	Φ10	53	30°

**BF011B**

O.D.	Hole	Length	Bend
Φ17	Φ10	53	30°

**BF011-2**

O.D.	Hole	Length	Bend
Φ17	Φ10		20°

**BF011-2B**

O.D.	Hole	Length	Bend
Φ17	Φ10		20°

**BF011-3**

O.D.	Hole	Length	Bend
Φ17	Φ10		25°

**BF011-3B**

O.D.	Hole	Length	Bend
Φ17	Φ10		25°

**BF012**

O.D.	Hole	Length	Bend
Φ17	Φ10	34	100°

**BF012B**

O.D.	Hole	Length	Bend
Φ17	Φ10	34	100°

**BF013**

O.D.	Hole	Length	Bend
Φ18	Φ10	55	30°

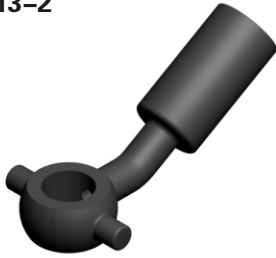
**BF013-2**

O.D.	Hole	Length	Bend
Φ18	Φ10	55	30°

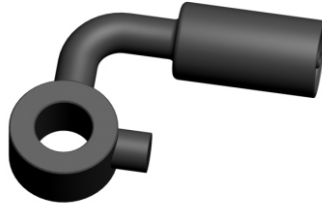
**BF014**

O.D.	Hole	Length	Bend
Φ18	Φ10	55	90°

**BF015**

O.D.	Hole	Length	Bend
Φ17	Φ10	50	

**BF015-2**

O.D.	Hole	Length	Bend
Φ17	Φ10	60	

**BF015-3**

O.D.	Hole	Length	Bend
Φ18	Φ10	55	

**BF015-4**

O.D.	Hole	Length	Bend
Φ19	Φ10	55	

**BF015-5**

O.D.	Hole	Length	Bend
Φ15	Φ10	50	

**BF016**

O.D.	Hole	Length	Bend
Φ17	Φ10	68	30°

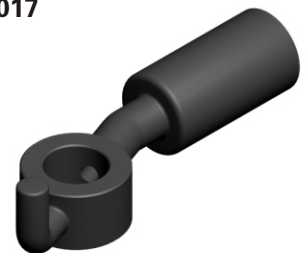
**BF017**

O.D.	Hole	Length	Bend
Φ17	Φ10	63	15°

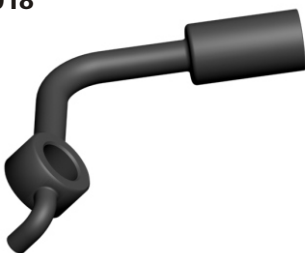
**BF018**

O.D.	Hole	Length	Bend
Φ17	Φ10	72	

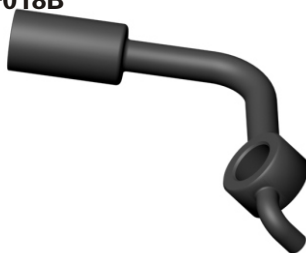
**BF018B**

O.D.	Hole	Length	Bend
Φ17	Φ10	72	

**BF019**

O.D.	Hole	Length	Bend
Φ17	Φ10	65	30°

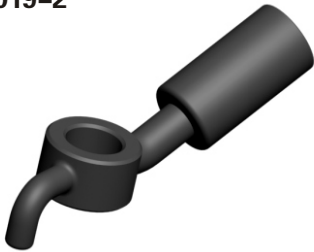
**BF019-2**

O.D.	Hole	Length	Bend
Φ17	Φ10	65	10°

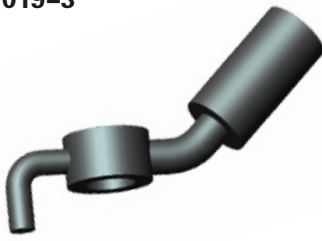
**BF019-3**

O.D.	Hole	Length	Bend
Φ17	Φ10		45°

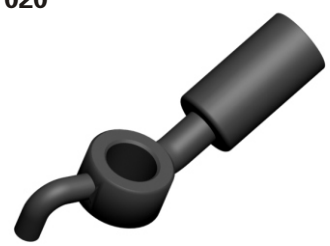
**BF020**

O.D.	Hole	Length	Bend
Φ17	Φ10	65	30°

**BF020B**

O.D.	Hole	Length	Bend
Φ17	Φ10	65	30°

**BF020-2**

O.D.	Hole	Length	Bend
Φ17	Φ10		50°

**BF020-2B**

O.D.	Hole	Length	Bend
Φ17	Φ10		50°

**BF021**

O.D.	Hole	Length	Bend
Φ18	Φ10	62	75°

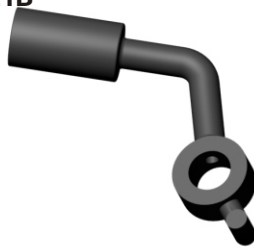
**BF021B**

O.D.	Hole	Length	Bend
Φ18	Φ10	62	75°

**BF022**

O.D.	Hole	Length	Bend
Φ17	Φ10	65	75°

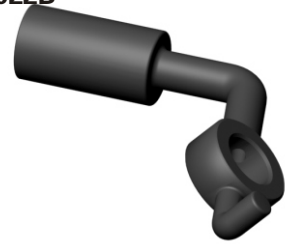
**BF022B**

O.D.	Hole	Length	Bend
Φ17	Φ10	65	75°

**BF023**

O.D.	Hole	Length	Bend
Φ19	Φ10	53	75°

**BF023B**

O.D.	Hole	Length	Bend
Φ19	Φ10	53	75°

**BF024**

O.D.	Hole	Length	Bend
Φ18	Φ10		70°

**BF024B**

O.D.	Hole	Length	Bend
Φ18	Φ10		70°

**BF025**

O.D.	Hole	Length	Bend
Φ18	Φ10	65	60°

**BF025B**

O.D.	Hole	Length	Bend
Φ18	Φ10	65	60°

**BF026**

O.D.	Hole	Length	Bend
Φ18	Φ10	65	45°

**BF026B**

O.D.	Hole	Length	Bend
Φ18	Φ10	65	45°

**BF027**

O.D.	Hole	Length	Bend
Φ17	Φ10	98	

**BF027B**

O.D.	Hole	Length	Bend
Φ17	Φ10	98	

**BF028**

O.D.	Hole	Length	Bend
Φ22	Φ10	75	90°

**BF028B**

O.D.	Hole	Length	Bend
Φ22	Φ10	75	90°

**BF028-2**

O.D.	Hole	Length	Bend
Φ20.5	Φ10	75	90°

**BF028-2B**

O.D.	Hole	Length	Bend
Φ20.5	Φ10	75	90°

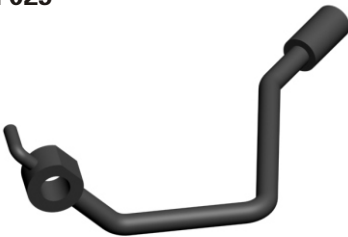
**BF029**

O.D.	Hole	Length	Bend
Φ21	Φ11	180	

**BF030**

O.D.	Hole	Length	Bend
Φ21	Φ11	182	

**BF031**

O.D.	Hole	Length	Bend
Φ22	Φ10	130	

**BF031B**

O.D.	Hole	Length	Bend
Φ22	Φ10	130	

**BF032**

O.D.	Hole	Length	Bend
Φ22	Φ10	59	

**BF032B**

O.D.	Hole	Length	Bend
Φ22	Φ10	59	

**BF033**

O.D.	Hole	Length	Bend
Φ22	Φ10	105	

**BF033B**

O.D.	Hole	Length	Bend
Φ22	Φ10	105	

**BF034**

O.D.	Hole	Length	Bend
Φ22	Φ10	113	

**BF034B**

O.D.	Hole	Length	Bend
Φ22	Φ10	113	

**BF035**

O.D.	Hole	Length	Bend
Φ22	Φ10	118	

**BF036**

O.D.	Hole	Length	Bend
Φ18	Φ10	102	

**BF036B**

O.D.	Hole	Length	Bend
Φ18	Φ10	102	

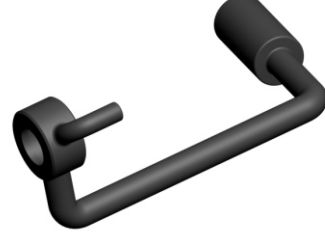
**BF037**

O.D.	Hole	Length	Bend
Φ22	Φ10	84	

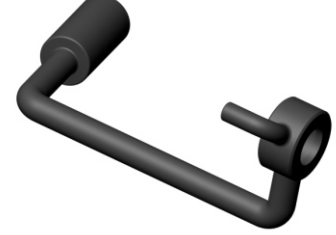
**BF037B**

O.D.	Hole	Length	Bend
Φ22	Φ10	84	

**BF038**

O.D.	Hole	Length	Bend
Φ21	Φ11	96	

**BF039**

O.D.	Hole	Length	Bend
Φ22	Φ11	81	

**BF039B**

O.D.	Hole	Length	Bend
Φ22	Φ11	81	

**BF040**

O.D.	Hole	Length	Bend
Φ22	Φ10	65	

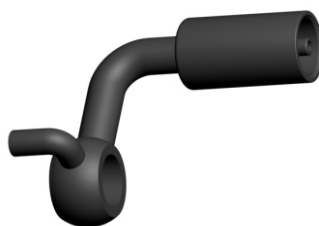
**BF041**

O.D.	Hole	Length	Bend
Φ22	Φ10	45	

**BF042**

O.D.	Hole	Length	Bend
Φ18	Φ10	51	



**BF042B**

O.D.	Hole	Length	Bend
Φ18	Φ10	51	

**BF043**

O.D.	Hole	Length	Bend
Φ19	Φ10	65	45°

**BF043B**

O.D.	Hole	Length	Bend
Φ19	Φ10	65	

**BF043-2**

O.D.	Hole	Length	Bend
Φ19	Φ10	65	25°

**BF043-2B**

O.D.	Hole	Length	Bend
Φ19	Φ10	65	25°

**BF044**

O.D.	Hole	Length	Bend
Φ17		90	120°

**BF045**

O.D.	Hole	Length	Bend
Φ30	Φ14	78	

**BF046**

O.D.	Hole	Length	Bend
Φ25	Φ11	60	

**BF046B**

O.D.	Hole	Length	Bend
Φ25	Φ11		30°

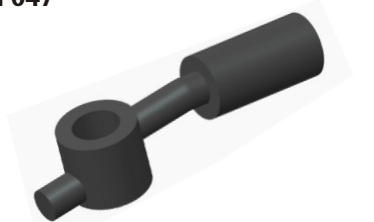
**BF047**

O.D.	Hole	Length	Bend
Φ17	Φ10	70	10°

**BF048**

O.D.	Hole	Length	Bend
			90°

**BF048B**

O.D.	Hole	Length	Bend
W18			90°

**BF049**

O.D.	Hole	Length	Bend
W17	Φ10		10°

**BF050**

O.D.	Hole	Length	Bend
W10	Φ10		90°

**BF050B**

O.D.	Hole	Length	Bend
W10	Φ10		90°

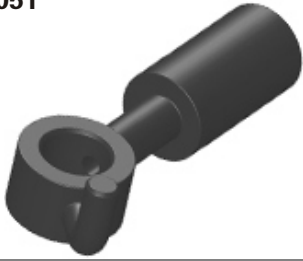
**BF051**

O.D.	Hole	Length	Bend
Φ17	Φ10	61	

**BF051B**

O.D.	Hole	Length	Bend
Φ17	Φ10	61	

**BF052**

O.D.	Hole	Length	Bend
Φ17	Φ10		

**BF053**

O.D.	Hole	Length	Bend
Φ17	Φ10		

**BF053B**

O.D.	Hole	Length	Bend
Φ17	Φ10		

**BF054**

O.D.	Hole	Length	Bend
Φ17	Φ10		40°

**BF054B**

O.D.	Hole	Length	Bend
Φ17	Φ10		40°

**BF055**

O.D.	Hole	Length	Bend
Φ17	Φ10		

**BF055B**

O.D.	Hole	Length	Bend
Φ17	Φ10		

**BF056**

O.D.	Hole	Length	Bend
Φ17	Φ10	70	

**BF057**

O.D.	Hole	Length	Bend
Φ17	Φ10	64	

**BF058**

O.D.	Hole	Length	Bend
Φ17	Φ10		

**BF058B**

O.D.	Hole	Length	Bend
Φ17	Φ10		

**BF059**

O.D.	Hole	Length	Bend
Φ17	Φ10		15°

**BF059B**

O.D.	Hole	Length	Bend
Φ17	Φ10		

**BF060**

O.D.	Hole	Length	Bend
Φ17	Φ10	67	

**BF061**

O.D.	Hole	Length	Bend
Φ17	Φ10		15°

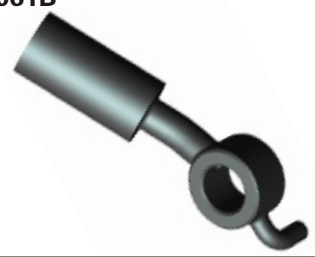
**BF061B**

O.D.	Hole	Length	Bend
Φ17	Φ10		15°

**BF062**

O.D.	Hole	Length	Bend
Φ17	Φ10		

**BF063**

O.D.	Hole	Length	Bend
Φ17	Φ10		10°

**BF064**

O.D.	Hole	Length	Bend
Φ18	Φ10		107°

**BF064B**

O.D.	Hole	Length	Bend
Φ18	Φ10		107°

**BF065**

O.D.	Hole	Length	Bend
Φ17	Φ10	65	

**BF066**

O.D.	Hole	Length	Bend
Φ17	Φ10		30°

**BF066B**

O.D.	Hole	Length	Bend
Φ17	Φ10		30°

**BF067**

O.D.	Hole	Length	Bend
Φ17	Φ10		60°

**BF068**

O.D.	Hole	Length	Bend
Φ17	Φ10		60°

**BF069**

O.D.	Hole	Length	Bend
Φ17	Φ10		60°

**BF069B**

O.D.	Hole	Length	Bend
Φ17	Φ10		60°

**BF070**

O.D.	Hole	Length	Bend
Φ17	Φ10		20°

**BF070B**

O.D.	Hole	Length	Bend
Φ17	Φ10		20°

**BF071**

O.D.	Hole	Length	Bend
Φ17	Φ10	62	

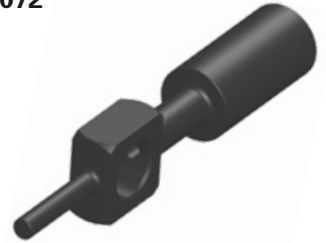
**BF072**

O.D.	Hole	Length	Bend
Φ16	Φ10	79	

**BF073**

O.D.	Hole	Length	Bend
Φ17	Φ10		30°

**BF073B**

O.D.	Hole	Length	Bend
Φ17	Φ10		30°

**BF074**

O.D.	Hole	Length	Bend
Φ17	Φ10	55	

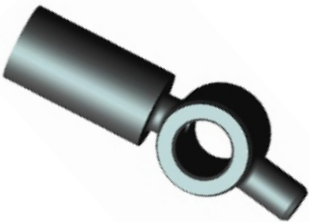
**BF074B**

O.D.	Hole	Length	Bend
Φ17	Φ10	55	

**BF075**

O.D.	Hole	Length	Bend
Φ17	Φ10	55	

**BF076**

O.D.	Hole	Length	Bend
Φ17	Φ10	55	

**BF077**

O.D.	Hole	Length	Bend
Φ17	Φ10		

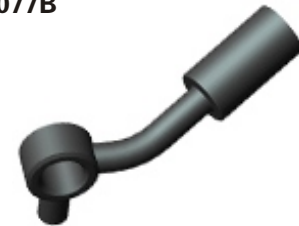
**BF077B**

O.D.	Hole	Length	Bend
Φ17	Φ10		

**BF078**

O.D.	Hole	Length	Bend
Φ17	Φ10	55	

**BF079**

O.D.	Hole	Length	Bend
Φ17	Φ10	55	

**BF080**

O.D.	Hole	Length	Bend
Φ17	Φ10		

**BF081**

O.D.	Hole	Length	Bend
Φ17	Φ10		

**BF081B**

O.D.	Hole	Length	Bend
Φ17	Φ10		

**BF082**

O.D.	Hole	Length	Bend
Φ17	Φ10.1		

**BF082B**

O.D.	Hole	Length	Bend
Φ17	Φ10.1		

**BF083**

O.D.	Hole	Length	Bend
Φ17	Φ10.2		

**BF083B**

O.D.	Hole	Length	Bend
Φ17	Φ10.2		

**BF084**

O.D.	Hole	Length	Bend
Φ17	Φ10.2		

**BF084B**

O.D.	Hole	Length	Bend
Φ17	Φ10.2		

**BF085**

O.D.	Hole	Length	Bend
Φ16.5	Φ10		

**BF086**

O.D.	Hole	Length	Bend
Φ17	Φ10		

**BF086B**

O.D.	Hole	Length	Bend
Φ17	Φ10		

**BF087**

O.D.	Hole	Length	Bend
Φ17	Φ10		

**BF087B**

O.D.	Hole	Length	Bend
Φ17	Φ10		

**BH001**

O.D.	Hole	Length	Bend
Φ17	Φ10	65	

**BH002**

O.D.	Hole	Length	Bend
Φ18	Φ10	60	

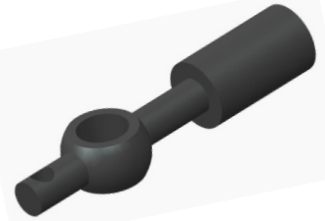
**BH003**

O.D.	Hole	Length	Bend
Φ17	Φ10	68	

**BH004**

O.D.	Hole	Length	Bend
Φ17	Φ10	68	30°

**BH004-2**

O.D.	Hole	Length	Bend
Φ17	Φ10	75	

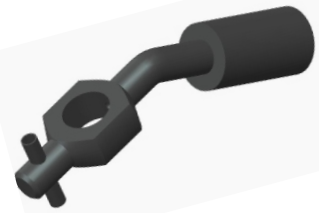
**BH005**

O.D.	Hole	Length	Bend
Φ17	Φ10	65	50°

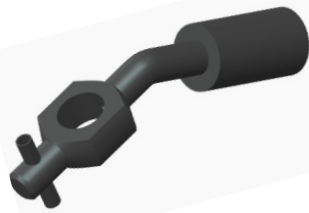
**BH005-2**

O.D.	Hole	Length	Bend
Φ17	Φ10	65	30°

**BH005-3**

O.D.	Hole	Length	Bend
Φ17	Φ10		10°

**BH005-4**

O.D.	Hole	Length	Bend
Φ17	Φ10		10°

**BH006**

O.D.	Hole	Length	Bend
Φ17	Φ10	66	

**BH007**

O.D.	Hole	Length	Bend
Φ17	Φ10	59	

**BH007B**

O.D.	Hole	Length	Bend
Φ17	Φ10	59	

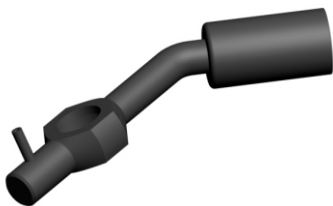
**BH008**

O.D.	Hole	Length	Bend
Φ17	Φ10	76	

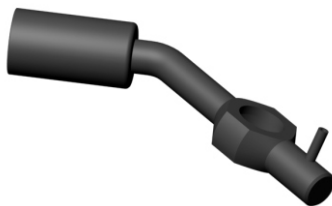
**BH008B**

O.D.	Hole	Length	Bend
Φ17	Φ10	76	

**BH008-2**

O.D.	Hole	Length	Bend
Φ17	Φ10		60°

**BH008-2B**

O.D.	Hole	Length	Bend
Φ17	Φ10	63	60°

**BH009**

O.D.	Hole	Length	Bend
Φ17	Φ10	63	45°

**BH009B**

O.D.	Hole	Length	Bend
Φ17	Φ10	63	45°

**BH009-2**

O.D.	Hole	Length	Bend
Φ17	Φ10	63	45°

**BH009-2B**

O.D.	Hole	Length	Bend
Φ17	Φ10	63	45°

**BH009-3**

O.D.	Hole	Length	Bend
Φ17	Φ10	63	45°

**BH009-3B**

O.D.	Hole	Length	Bend
Φ17	Φ10	63	45°

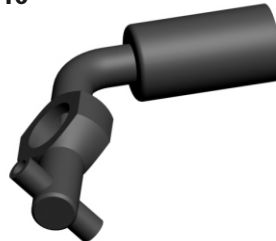
**BH010**

O.D.	Hole	Length	Bend
Φ17	Φ10	60	45°

**BH011**

O.D.	Hole	Length	Bend
Φ17	Φ10	66	45°

**BH012**

O.D.	Hole	Length	Bend
Φ17	Φ10	50	45°

**BH012-2**

O.D.	Hole	Length	Bend
Φ18	Φ10	50	45°

**BH012-3**

O.D.	Hole	Length	Bend
Φ19	Φ10	55	45°

**BH012-4**

O.D.	Hole	Length	Bend
Φ17	Φ10	72.7	45°

**BH012-5**

O.D.	Hole	Length	Bend
Φ17	Φ10	64	45°

**BH012-6**

O.D.	Hole	Length	Bend
Φ17	Φ10	67.4	45°

**BH013**

O.D.	Hole	Length	Bend
Φ18	Φ10	57	

**BH013-3**

O.D.	Hole	Length	Bend
Φ18	Φ10	68.5	30°

**BH014**

O.D.	Hole	Length	Bend
Φ18	Φ10	67	30°

**BH014-2**

O.D.	Hole	Length	Bend
Φ18	Φ10	70	15°

**BH014-3**

O.D.	Hole	Length	Bend
Φ18	Φ10	70	20°

**BH015**

O.D.	Hole	Length	Bend
Φ17	Φ10	66	30°

**BH015-2**

O.D.	Hole	Length	Bend
Φ18	Φ10	68	30°

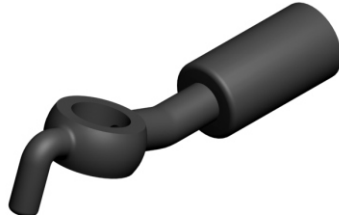
**BH016**

O.D.	Hole	Length	Bend
Φ17	Φ10	66	20°

**BH016-2**

O.D.	Hole	Length	Bend
Φ18.2	Φ10	56	70°

**BH016-3**

O.D.	Hole	Length	Bend
Φ18	Φ10		10°

**BH017**

O.D.	Hole	Length	Bend
Φ18	Φ10	53	

**BH017-2**

O.D.	Hole	Length	Bend
Φ19	Φ10	53	

**BH017-3**

O.D.	Hole	Length	Bend
Φ19	Φ10.5	53	

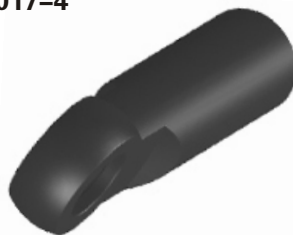
**BH017-4**

O.D.	Hole	Length	Bend
Φ18	Φ10	54	

**BH017-5**

O.D.	Hole	Length	Bend
Φ18.5	Φ10	55	



**BH018**

O.D.	Hole	Length	Bend
Φ17	Φ10	60	

**BH018-2**

O.D.	Hole	Length	Bend
Φ17	Φ10	50	

**BH019**

O.D.	Hole	Length	Bend
Φ17	Φ10	65	15°

**BH020**

O.D.	Hole	Length	Bend
Φ17	Φ10	68	30°

**BH021**

O.D.	Hole	Length	Bend
Φ17	Φ10	65	

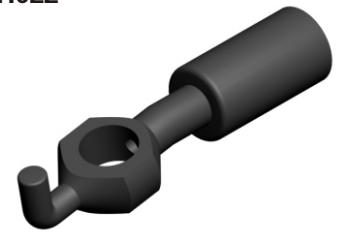
**BH022**

O.D.	Hole	Length	Bend
Φ17	Φ10	65	10°

**BH023**

O.D.	Hole	Length	Bend
Φ17	Φ10	71	30°

**BH023-2**

O.D.	Hole	Length	Bend
Φ17	Φ12	71	30°

**BH024**

O.D.	Hole	Length	Bend
Φ18	Φ10	85	

**BH024B**

O.D.	Hole	Length	Bend
Φ18	Φ10	85	

**BH025**

O.D.	Hole	Length	Bend
Φ20	Φ10	50	

**BH026**

O.D.	Hole	Length	Bend
Φ17	Φ10	65	

**BH027**

O.D.	Hole	Length	Bend
Φ17	Φ10	64	15°

**BH027B**

O.D.	Hole	Length	Bend
Φ17	Φ10	64	15°

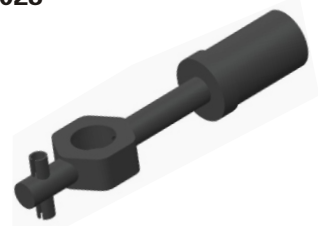
**BH028**

O.D.	Hole	Length	Bend
Φ17	Φ10	79	

**BH029**

O.D.	Hole	Length	Bend
Φ17	Φ10	62	30°

**BH030**

O.D.	Hole	Length	Bend
Φ20	Φ10	64	90°

**BH031**

O.D.	Hole	Length	Bend
Φ17	Φ10		90°

**BH032**

O.D.	Hole	Length	Bend
Φ17	Φ10		35°

**BH032B**

O.D.	Hole	Length	Bend
Φ17	Φ10		45°

**BH033**

O.D.	Hole	Length	Bend
Φ17	Φ10		70°

**BH034**

O.D.	Hole	Length	Bend
Φ17	Φ10		90°

**BH034B**

O.D.	Hole	Length	Bend
Φ17	Φ10		90°

**BH035**

O.D.	Hole	Length	Bend
Φ17	Φ10		40°

**BH035B**

O.D.	Hole	Length	Bend
Φ17	Φ10		40°

**BH036**

O.D.	Hole	Length	Bend
Φ17	Φ10		15°

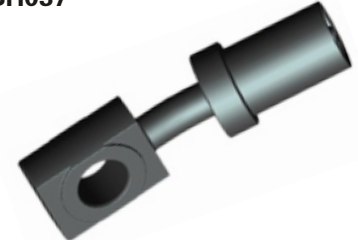
**BH037**

O.D.	Hole	Length	Bend
Width 18	Φ10		10°

**BH038**

O.D.	Hole	Length	Bend
Φ17	Φ10	69.7	

**BH039**

O.D.	Hole	Length	Bend
Φ17	Φ12		

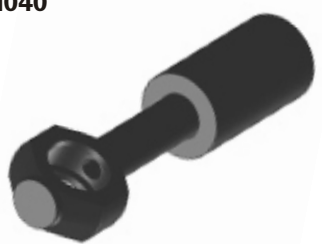
**BH040**

O.D.	Hole	Length	Bend
Φ17	Φ10	62	

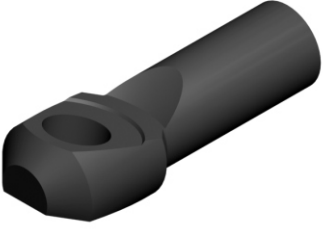
**BI001**

O.D.	Hole	Length	Bend
Φ18	Φ10	53	15°

**BI001-2**

O.D.	Hole	Length	Bend
Φ18	Φ10	53	15°

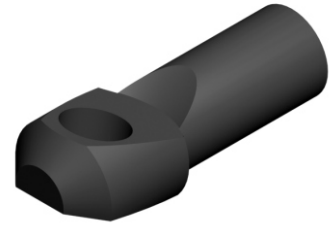
**BI001-3**

O.D.	Hole	Length	Bend
Φ18	Φ10	47	15°

**BI001-4**

O.D.	Hole	Length	Bend
Φ20	Φ12	52	15°

**BI001-5**

O.D.	Hole	Length	Bend
Φ18	Φ12	51.5	15°

**BI002**

O.D.	Hole	Length	Bend
Φ20	Φ10	46	

**BI002-2**

O.D.	Hole	Length	Bend
Φ22	Φ10	46	

**BI002-3**

O.D.	Hole	Length	Bend
Φ21	Φ10	46	

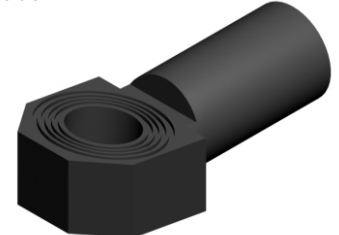
**BI003**

Width	Hole	Length	Bend
19	Φ10	43	15°

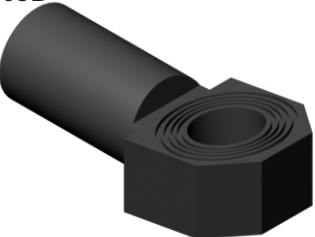
**BI003B**

Width	Hole	Length	Bend
19	Φ10	43	15°

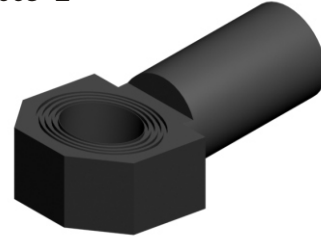
**BI003-2**

Width	Hole	Length	Bend
20	Φ11	44	15°

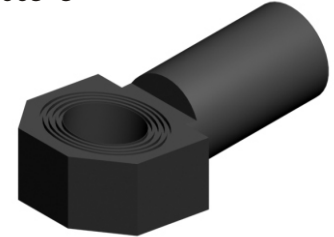
**BI003-3**

Width	Hole	Length	Bend
18	Φ10	44	15°

**BI003-4**

Width	Hole	Length	Bend
19.5	Φ10	43	15°

**BI003-5**

Width	Hole	Length	Bend
19	Φ11	44.2	15°

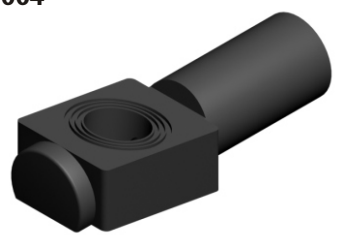
**BI004**

Width	Hole	Length	Bend
19.5	Φ10	48	15°

**BI004-2**

Width	Hole	Length	Bend
19.5	Φ10	49	15°

**BI005**

Width	Hole	Length	Bend
20	Φ10	38	

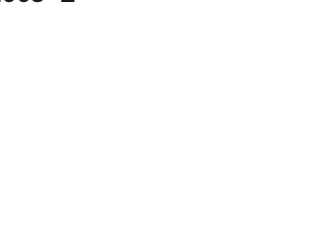
**BI005-2**

Width	Hole	Length	Bend
20	Φ11	38	

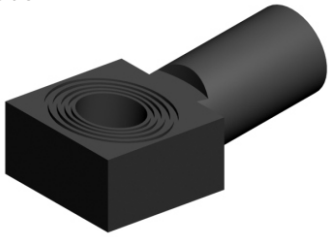
**BI006**

Width	Hole	Length	Bend
20	Φ10	47	15°

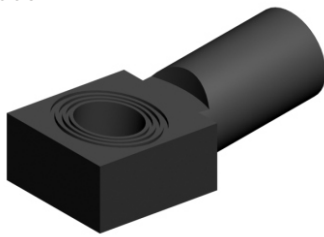
**BI006-2**

Width	Hole	Length	Bend
18	Φ10	48	15°

**BI006-3**

Width	Hole	Length	Bend
20	Φ11	47	15°

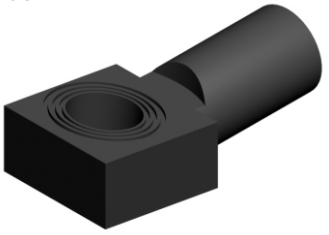
**BI006-4**

Width	Hole	Length	Bend
19	Φ10	47	12°

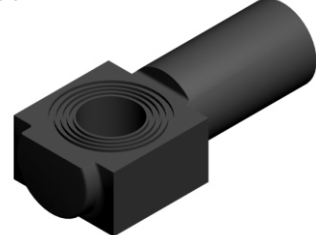
**BI007**

Width	Hole	Length	Bend
20	Φ10	48	

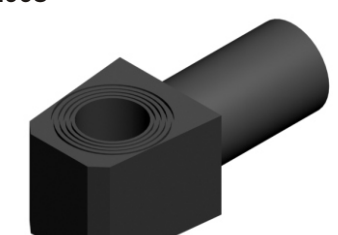
**BI008**

Width	Hole	Length	Bend
19	Φ10	45	

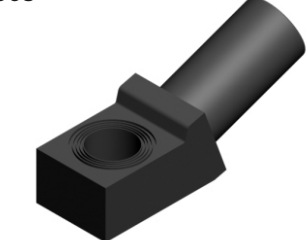
**BI009**

Width	Hole	Length	Bend
17	Φ10	45	15°

**BI009-2**

Width	Hole	Length	Bend
20	Φ10	49	15°

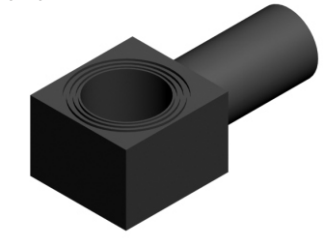
**BI010**

Width	Hole	Length	Bend
22	Φ15	51	

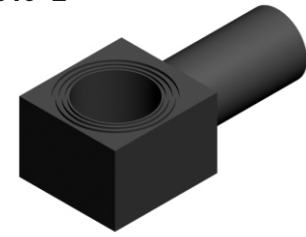
**BI010-2**

Width	Hole	Length	Bend
18	Φ11	41	

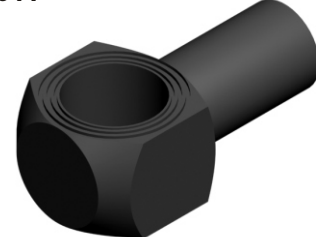
**BI011**

Width	Hole	Length	Bend
22.5	Φ15	44	

**BI011-2**

Width	Hole	Length	Bend
20	Φ11	42	

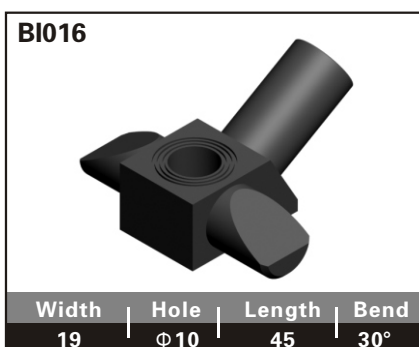
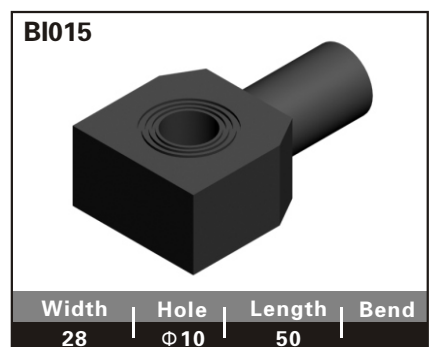
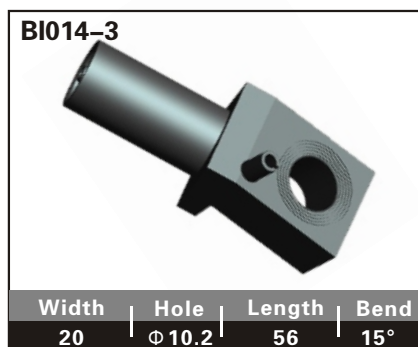
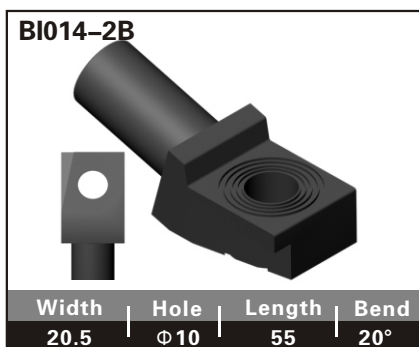
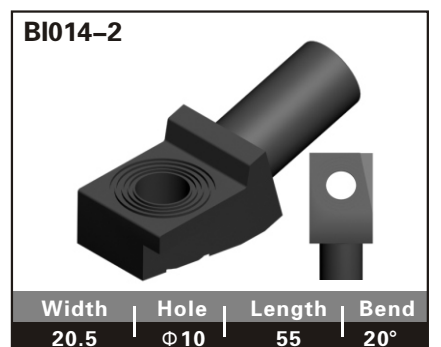
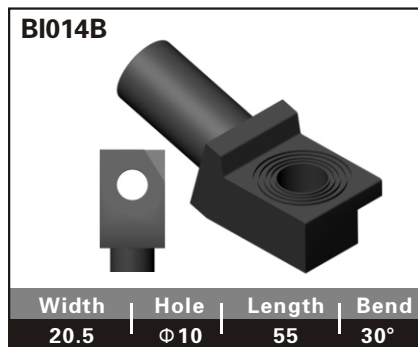
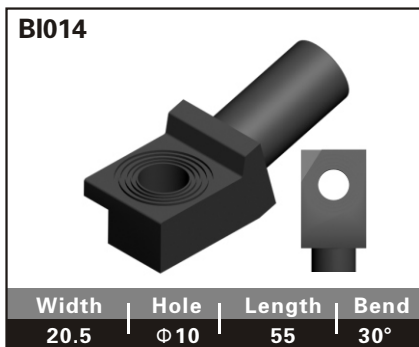
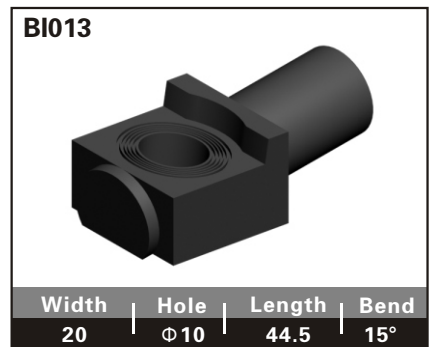
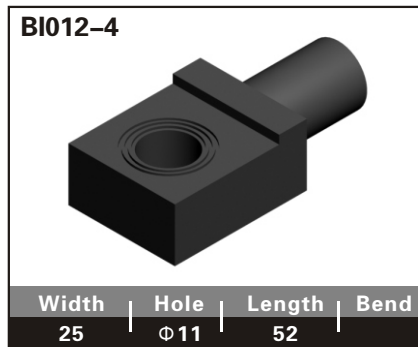
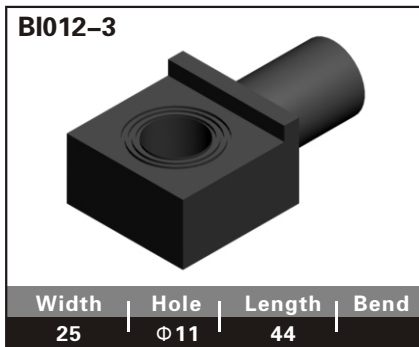
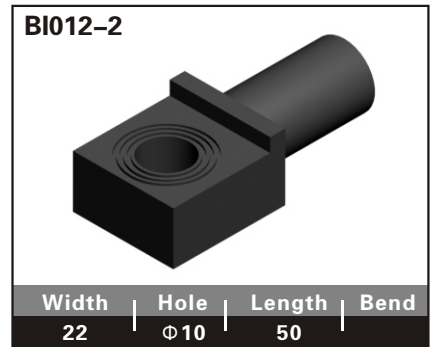
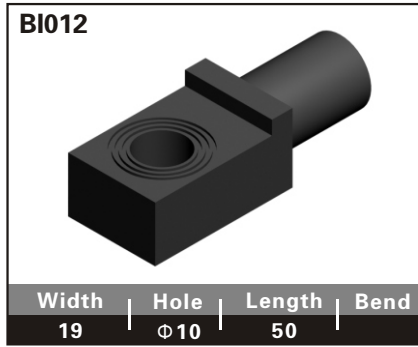
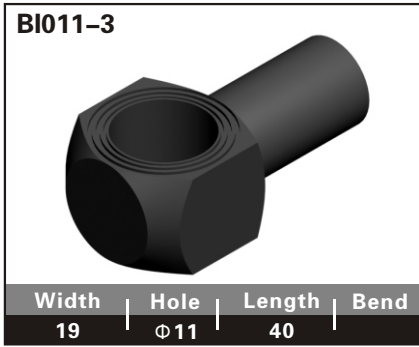

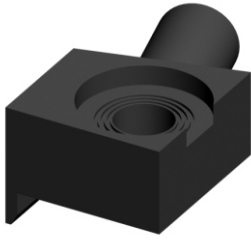
**BI018**

Width	Hole	Length	Bend
28	Φ10	50	

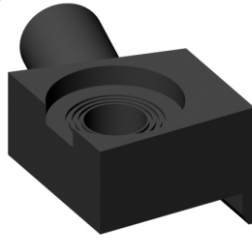
**BI018B**

Width	Hole	Length	Bend
28	Φ10	50	

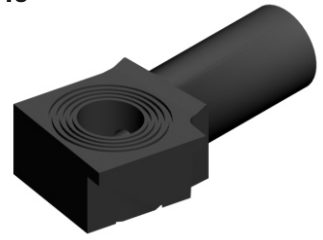
**BI019**

Width	Hole	Length	Bend
22	Φ10	50	15°

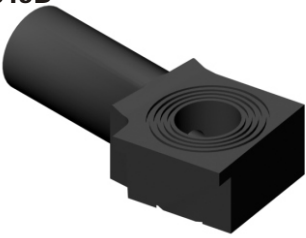
**BI019B**

Width	Hole	Length	Bend
22	Φ10	50	15°

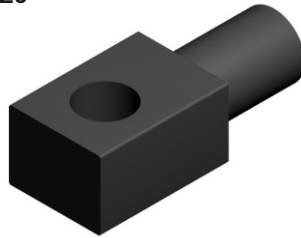
**BI020**

Width	Hole	Length	Bend
20	Φ11	47	

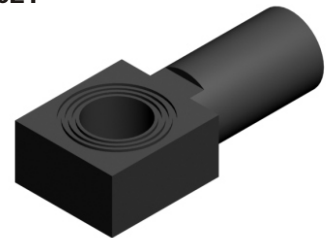
**BI021**

Width	Hole	Length	Bend
20	Φ10	47	

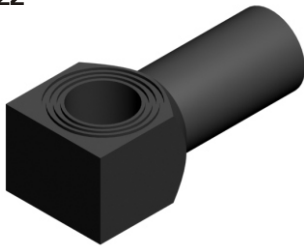
**BI022**

Width	Hole	Length	Bend
19	Φ11	44	

**BI023**

Width	Hole	Length	Bend
20	Φ10	41	

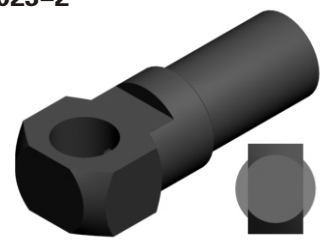
**BI023-2**

Width	Hole	Length	Bend
18	Φ10	45	

**BI023-3**

Width	Hole	Length	Bend
19	Φ10	41	

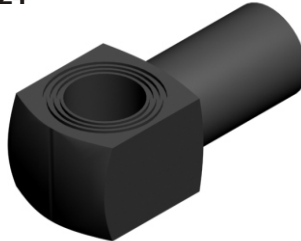
**BI024**

Width	Hole	Length	Bend
18	Φ10	41	

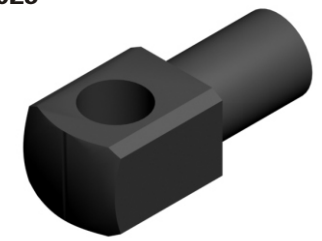
**BI025**

Width	Hole	Length	Bend
18	Φ10	43	

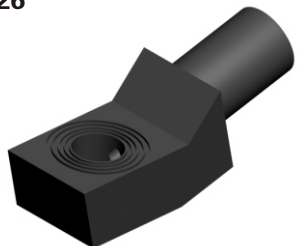
**BI026**

Width	Hole	Length	Bend
19	Φ11	55	

**BI026-2**

Width	Hole	Length	Bend
16.5	Φ10	55	

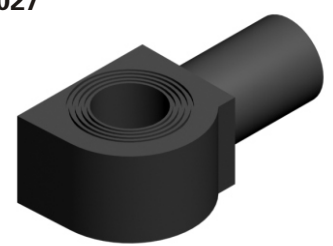
**BI027**

Width	Hole	Length	Bend
22	Φ11	45	

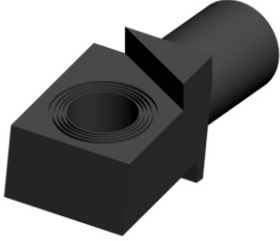
**BI028**

Width	Hole	Length	Bend
19	Φ10	49	

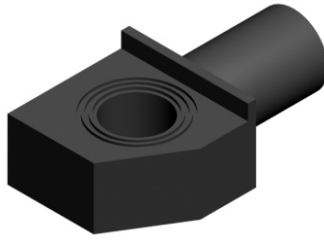
**BI029**

Width	Hole	Length	Bend
25	Φ10	50	

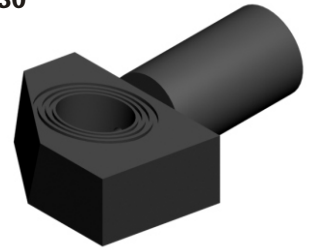
**BI030**

Width	Hole	Length	Bend
28	Φ10	49	

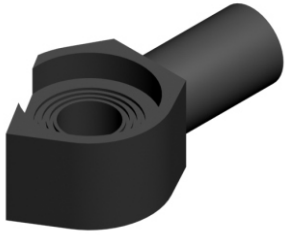
**BI031**

Width	Hole	Length	Bend
25	Φ10	54	

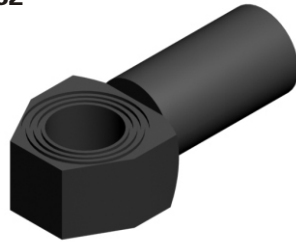
**BI032**

Width	Hole	Length	Bend
20	Φ10	43	

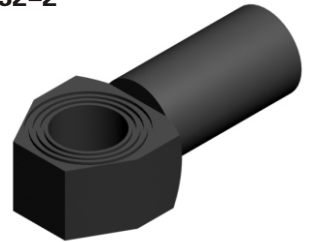
**BI032-2**

Width	Hole	Length	Bend
20	Φ10	43	

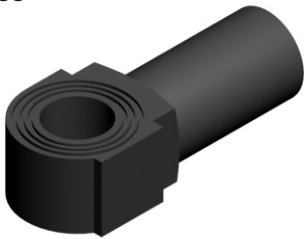
**BI033**

Width	Hole	Length	Bend
19	Φ10	46	

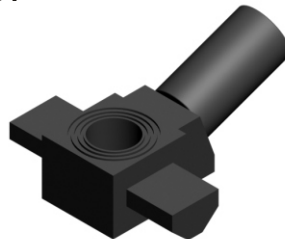
**BI034**

Width	Hole	Length	Bend
44.5	Φ10		20°

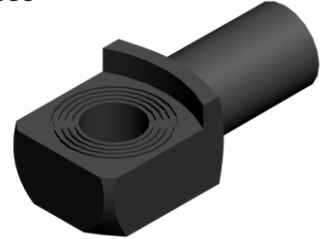
**BI035**

Width	Hole	Length	Bend
20	Φ10	45	

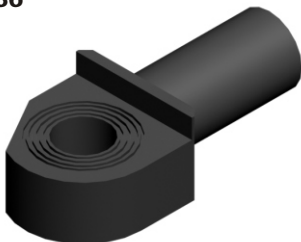
**BI036**

Width	Hole	Length	Bend
24	Φ10	51	

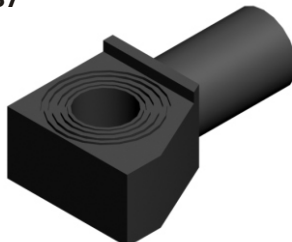
**BI037**

Width	Hole	Length	Bend
25	Φ10	43	

**BI037-2**

Width	Hole	Length	Bend
24.5	Φ10	44	

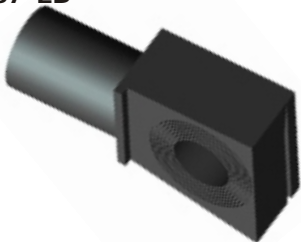
**BI037-2B**

Width	Hole	Length	Bend
24.5	Φ10	44	

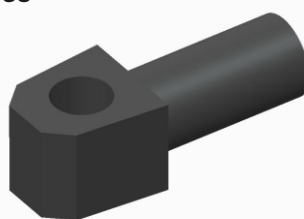
**BI038**

Width	Hole	Length	Bend
19	Φ10	49	

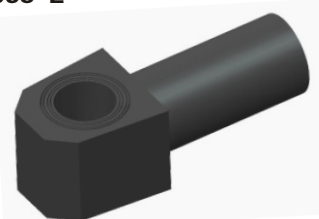
**BI038-2**

Width	Hole	Length	Bend
19	Φ10	49	

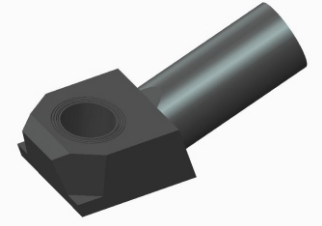
**BI039**

Width	Hole	Length	Bend
19.5	Φ11	48	

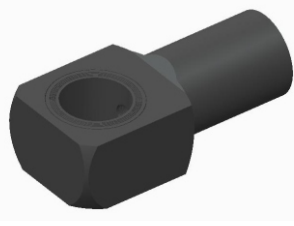
**BI040**

Width	Hole	Length	Bend
19	Φ11	41	

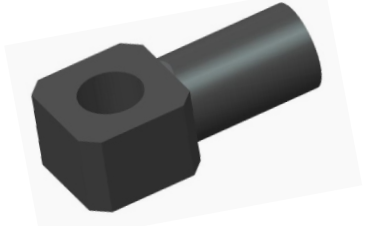
**BI041**

Width	Hole	Length	Bend
19	Φ10	40.5	

**BI042**

Width	Hole	Length	Bend
19	Φ11	41	10°

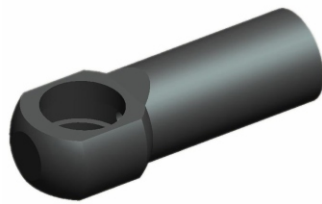
**BI043**

Width	Hole	Length	Bend
22.5	Φ12	49	

**BI043-2**

Width	Hole	Length	Bend
20	Φ12	48	

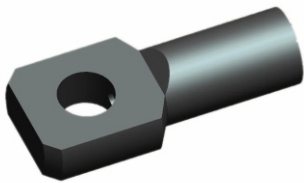
**BI044**

Width	Hole	Length	Bend
22	Φ10	46.5	

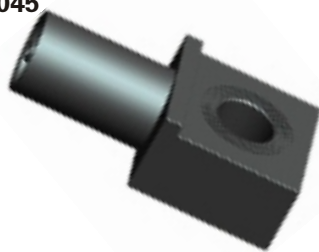
**BI045**

Width	Hole	Length	Bend
24	Φ9.5	46.2	

**BI046**

Width	Hole	Length	Bend
19.6	Φ10.2	46.6	

**BI047**

Width	Hole	Length	Bend
19	Φ11.3	41	

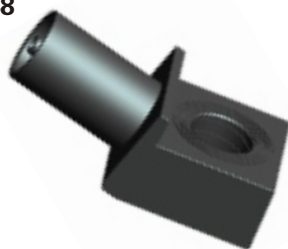
**BI048**

Width	Hole	Length	Bend
25	Φ11	49.5	15°

**BI049**

Width	Hole	Length	Bend
23	Φ11	60	15°

**BI049B**

Width	Hole	Length	Bend
23	Φ11	60	15°

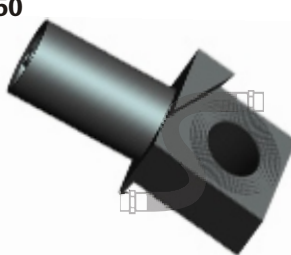
**BI050**

Width	Hole	Length	Bend
19	Φ10	46.4	10°

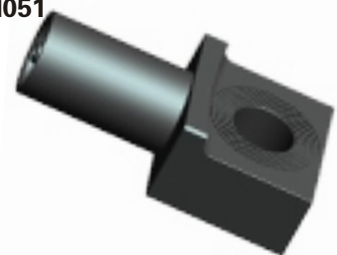
**BI051**

Bend



BI052



Width	Hole	Length	Bend
16	Φ9		

BI052B



Width	Hole	Length	Bend
16	Φ9		

BI053

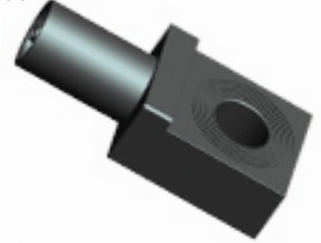

Width	Hole	Length	Bend
25	Φ11	53	

BI054



Width	Hole	Length	Bend
19.6	Φ10.2	45	25°

BI055

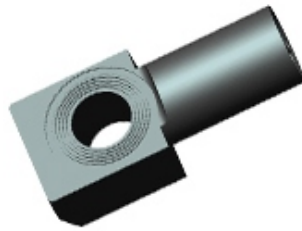

Width	Hole	Length	Bend
20	Φ10.2		

BI056

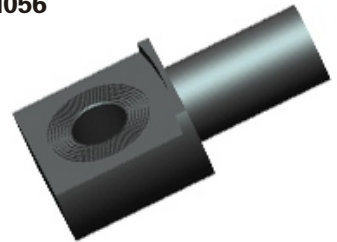

Width	Hole	Length	Bend
Φ26	Φ9.6	49.6	

BI057

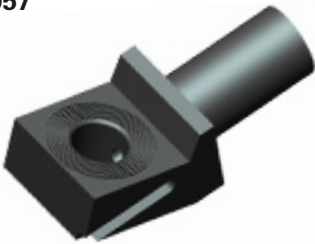

Width	Hole	Length	Bend
22.8	Φ10.2		20°

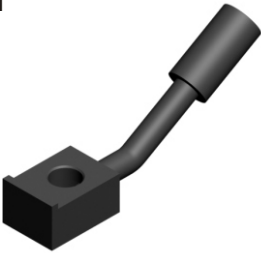
**BK001**

Width	Hole	Length	Bend
20	Φ10	95	30°

**BK002**

Width	Hole	Length	Bend
19	Φ10	100	60°

**BK003**

Width	Hole	Length	Bend
17	Φ10	56	

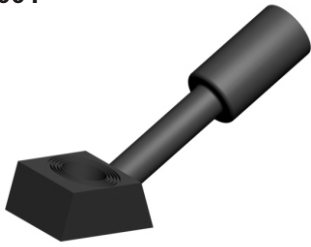
**BK004**

Width	Hole	Length	Bend
17	Φ10	80	35°

**BK005**

Width	Hole	Length	Bend
17	Φ10	65	

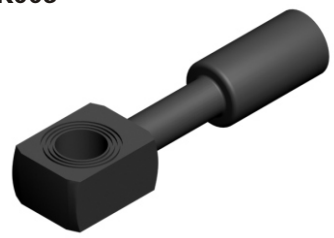
**BK006**

Width	Hole	Length	Bend
20	Φ10	60	

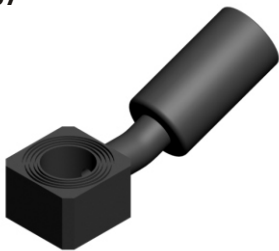
**BK007**

Width	Hole	Length	Bend
20	Φ10	60	20°

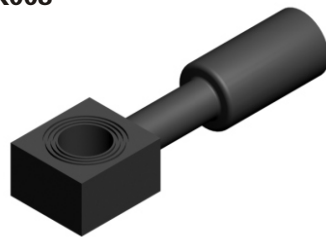
**BK008**

Width	Hole	Length	Bend
18	Φ10	65	

**BK009**

Width	Hole	Length	Bend
18	Φ10	80	60°

**BK010**

Width	Hole	Length	Bend
17	Φ10	80	45°

**BK011**

Width	Hole	Length	Bend
22	Φ10	60	

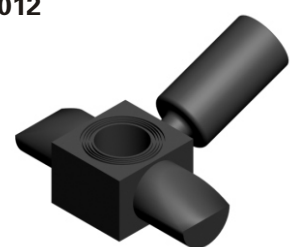
**BK012**

Width	Hole	Length	Bend
20	Φ11	50	15°

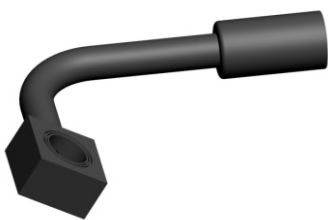
**BK013**

Width	Hole	Length	Bend
18	Φ10	125	

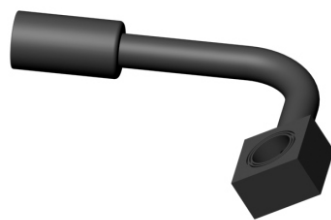
**BK013B**

Width	Hole	Length	Bend
18	Φ10	125	

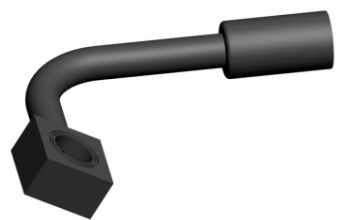
**BK013-2**

Width	Hole	Length	Bend
19	Φ10	125	

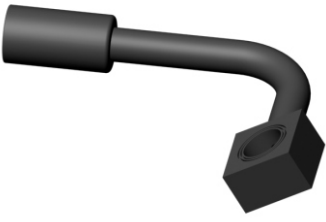
**BK013-2B**

Width	Hole	Length	Bend
19	Φ10	125	

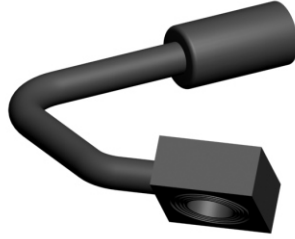
**BK014**

Width	Hole	Length	Bend
22	Φ10	70	

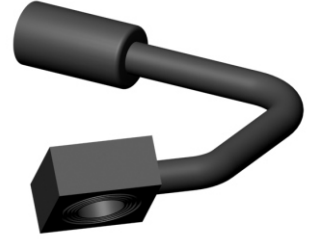
**BK014B**

Width	Hole	Length	Bend
22	Φ10	70	

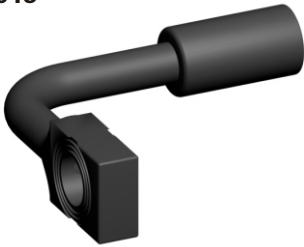
**BK015**

Width	Hole	Length	Bend
17	Φ10	115	90°

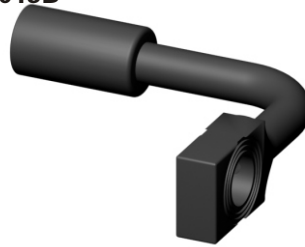
**BK015B**

Width	Hole	Length	Bend
17	Φ10	115	90°

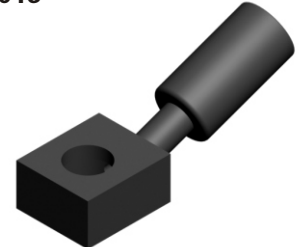
**BK016**

Width	Hole	Length	Bend
19	Φ10	62	20°

**BK017**

Width	Hole	Length	Bend
19	Φ10	80	20°

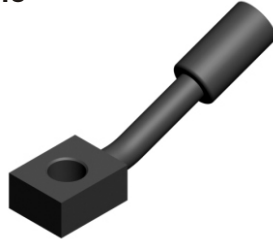
**BK018**

Width	Hole	Length	Bend
19	Φ10	83	20°

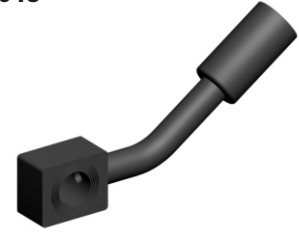
**BK019**

Width	Hole	Length	Bend
17	Φ10	90	45°

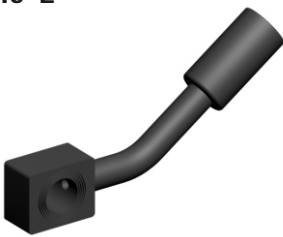
**BK019-2**

Width	Hole	Length	Bend
20	Φ10	90	26°

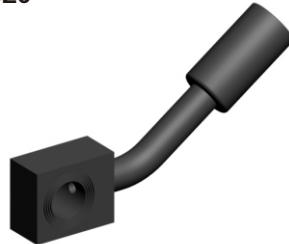
**BK020**

Width	Hole	Length	Bend
19	Φ10	85	35°

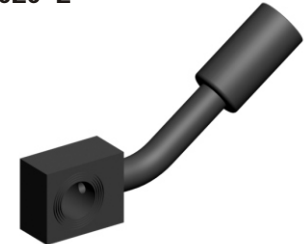
**BK020-2**

Width	Hole	Length	Bend
19	Φ10	140	20°

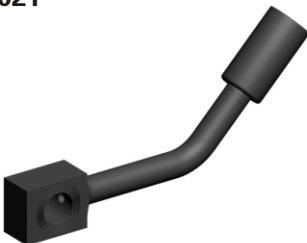
**BK021**

Width	Hole	Length	Bend
17	Φ10	110	45°

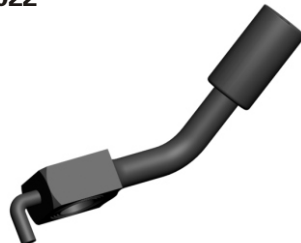
**BK022**

Width	Hole	Length	Bend
17	Φ10	95	45°

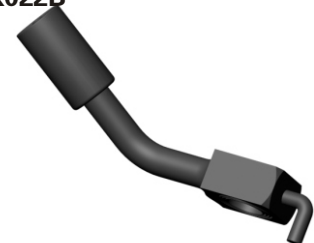
**BK022B**

Width	Hole	Length	Bend
17	Φ10	95	45°

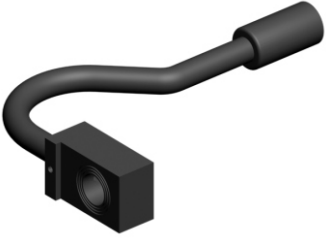
**BK023**

Width	Hole	Length	Bend
20	Φ10	200	90°

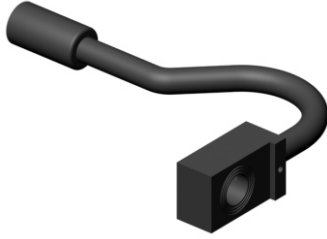
**BK023B**

Width	Hole	Length	Bend
20	Φ10	200	90°

**BK024**

Width	Hole	Length	Bend
22	Φ10	180	

**BK024B**

Width	Hole	Length	Bend
22	Φ10	180	

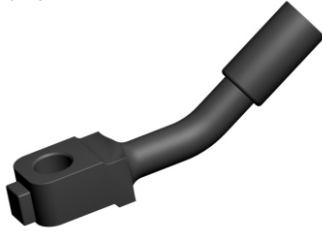
**BK025**

Width	Hole	Length	Bend
18	Φ10	85	35°

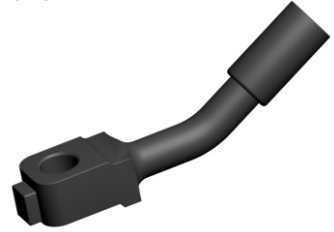
**BK025-2**

Width	Hole	Length	Bend
16	Φ10	85	35°

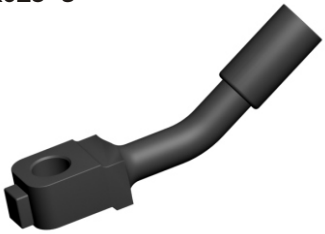
**BK025-3**

Width	Hole	Length	Bend
19	Φ10	85	30°

**BK026**

Width	Hole	Length	Bend
20	Φ11	110	20°

**BK027**

Width	Hole	Length	Bend
20	Φ11	115	30°

**BK027-2**

Width	Hole	Length	Bend
21	Φ11		

**BK028**

Width	Hole	Length	Bend
20	Φ10	90	20°

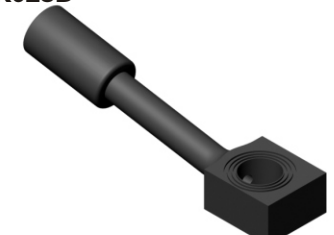
**BK028B**

Width	Hole	Length	Bend
20	Φ10	90	20°

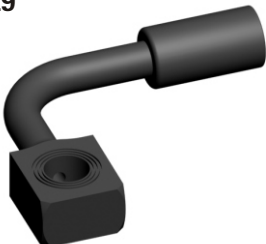
**BK029**

Width	Hole	Length	Bend
19	Φ10	110	90°

**BK029-2**

Width	Hole	Length	Bend
18	Φ10,16		

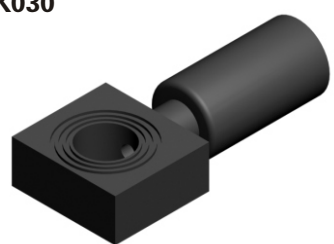
**BK030**

Width	Hole	Length	Bend
22	Φ10	47	

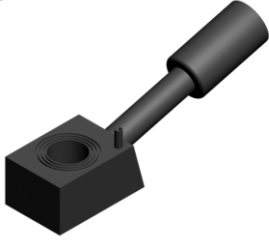
**BK031**

Width	Hole	Length	Bend
20	Φ11	80	15°

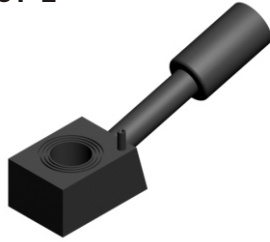
**BK031-2**

Width	Hole	Length	Bend
20	Φ11	90	15°

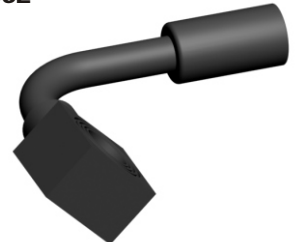
**BK032**

Width	Hole	Length	Bend
20	Φ11	110	

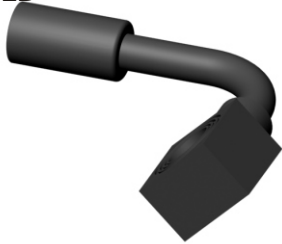
**BK032B**

Width	Hole	Length	Bend
20	Φ11	110	

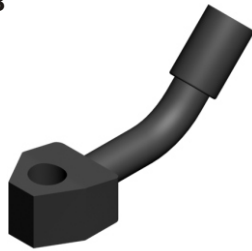
**BK033**

Width	Hole	Length	Bend
26	Φ10	85	45°

**BK034**

Width	Hole	Length	Bend
20	Φ10	150	

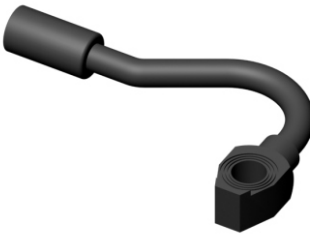
**BK034B**

Width	Hole	Length	Bend
20	Φ10	150	

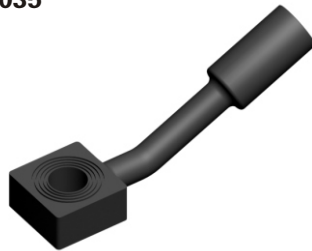
**BK035**

Width	Hole	Length	Bend
22	Φ10	85	30°

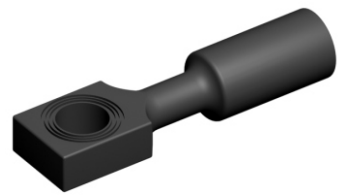
**BK036**

Width	Hole	Length	Bend
17	Φ10	60	

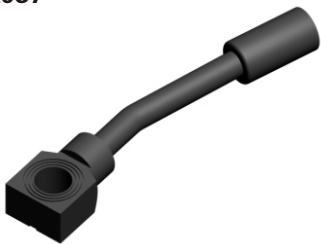
**BK037**

Width	Hole	Length	Bend
20	Φ10	125	15°

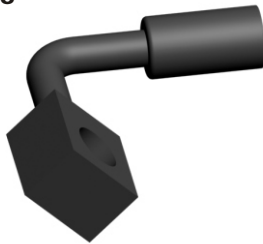
**BK038**

Width	Hole	Length	Bend
20	Φ11	100	

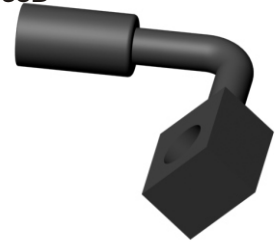
**BK038B**

Width	Hole	Length	Bend
20	Φ11	100	

**BK038-2**

Width	Hole	Length	Bend
20	Φ11		90°

**BK039**

Width	Hole	Length	Bend
29	Φ10	150	

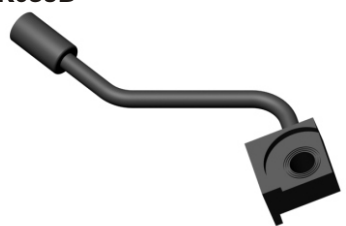
**BK039B**

Width	Hole	Length	Bend
29	Φ10	150	

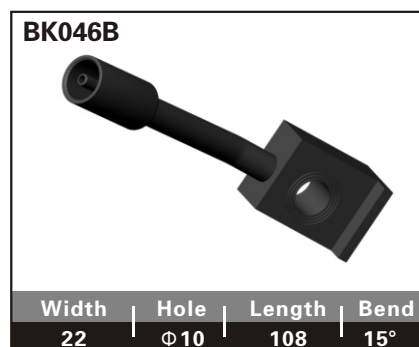
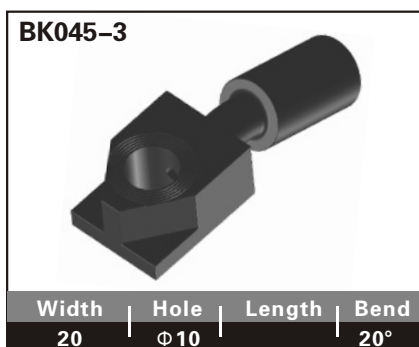
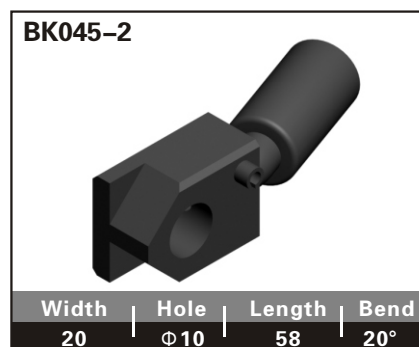
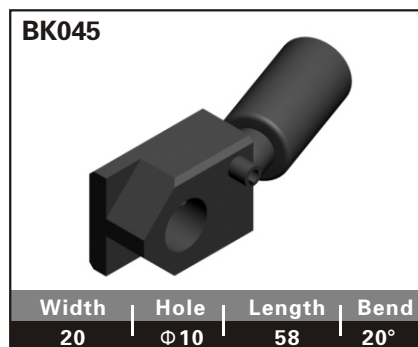
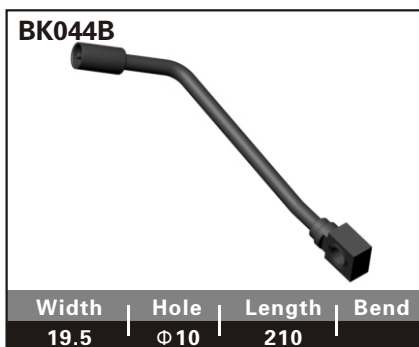
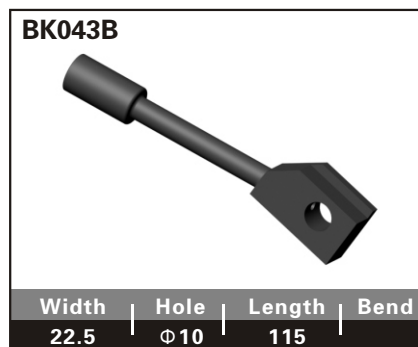
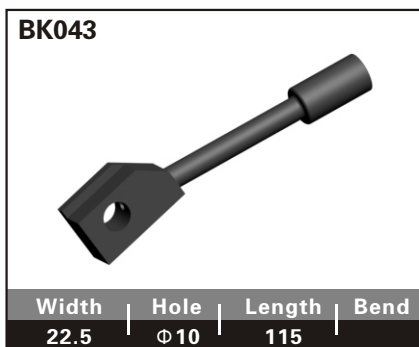
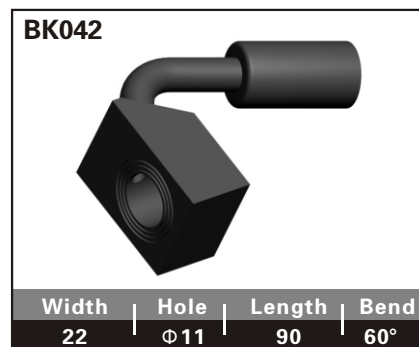
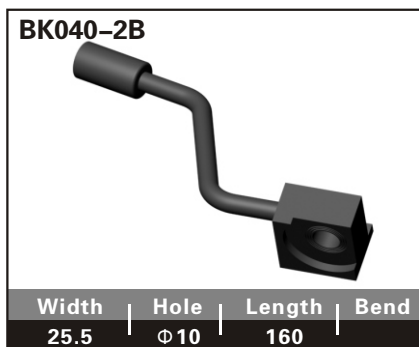
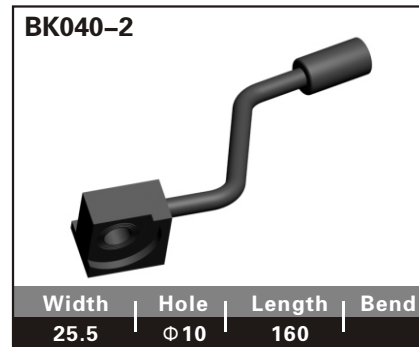
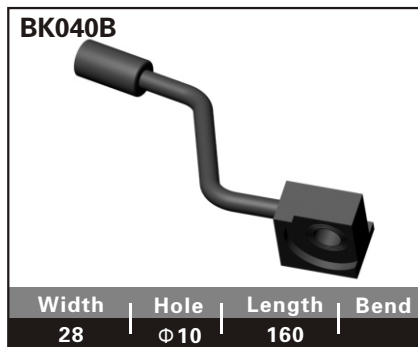
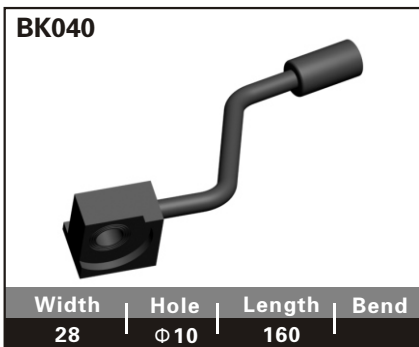

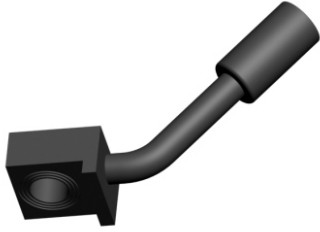
**BK047**

Width	Hole	Length	Bend
22	Φ10	95	60°

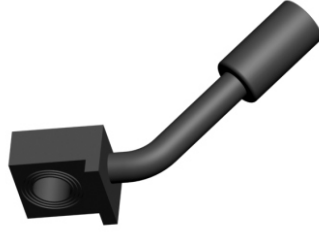
**BK047-2**

Width	Hole	Length	Bend
22	Φ10	115	15°

**BK048**

Width	Hole	Length	Bend
19	Φ10	150	115°

**BK048B**

Width	Hole	Length	Bend
19	Φ10	150	115°

**BK048-2**

Width	Hole	Length	Bend
19	Φ10	118	

**BK048-2B**

Width	Hole	Length	Bend
19	Φ10	118	0°

**BK049**

Width	Hole	Length	Bend
22	Φ10	57	30°

**BK049B**

Width	Hole	Length	Bend
22	Φ10	57	30°

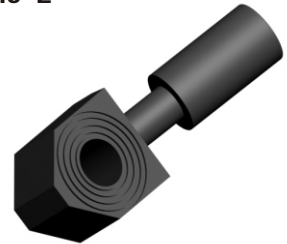
**BK049-2**

Width	Hole	Length	Bend
20	Φ10	65	30°

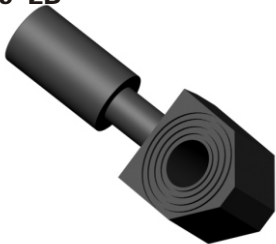
**BK049-2B**

Width	Hole	Length	Bend
20	Φ10	65	30°

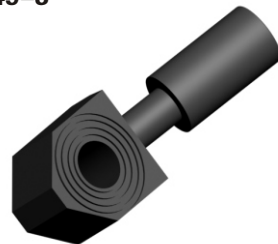
**BK049-3**

Width	Hole	Length	Bend
22	Φ10	57	30°

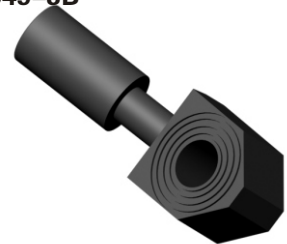
**BK049-3B**

Width	Hole	Length	Bend
22	Φ10	57	30°

**BK050**

Width	Hole	Length	Bend
22.5	Φ10	150	90°

**BK051**

Width	Hole	Length	Bend
20	Φ10	113	

**BK051-2**

Width	Hole	Length	Bend
22	Φ10	113	

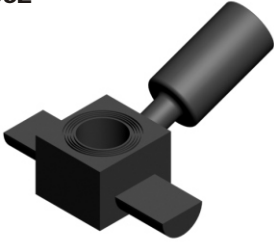
**BK052**

Width	Hole	Length	Bend
19	Φ11	57	20°

**BK053**

Width	Hole	Length	Bend
22	Φ10	235	

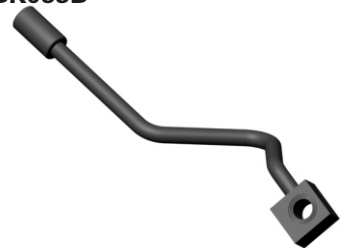
**BK053B**

Width	Hole	Length	Bend
22	Φ10	235	

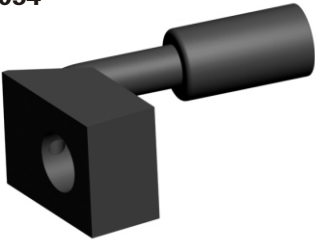
**BK054**

Width	Hole	Length	Bend
22.5	Φ11	90	80°

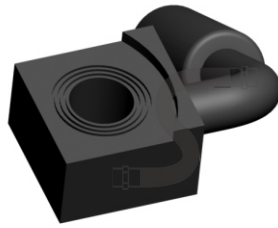
**BK055**

Width	Hole	Length	Bend
22.5	Φ10	85	

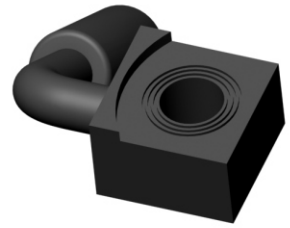
**BK055B**

Width	Hole	Length	Bend
22.5	Φ10	85	

**BK056**

Width	Hole	Length	Bend
22	Φ10	65	

**BK056B**

Width	Hole	Length	Bend
22	Φ10	65	

**BK057**

Width	Hole	Length	Bend
20.5	Φ10	140	

**BK057B**

Width	Hole	Length	Bend
20.5	Φ10	140	

**BK057-2**

Width	Hole	Length	Bend
19	Φ10	140	

**BK057-2B**

Width	Hole	Length	Bend
19	Φ10	140	

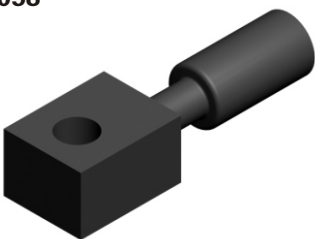
**BK058**

Width	Hole	Length	Bend
20	Φ10	61	

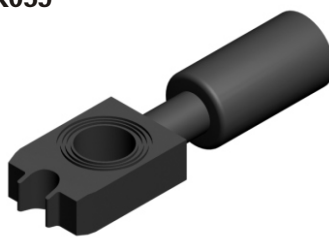
**BK059**

Width	Hole	Length	Bend
17	Φ10	64	

**BK059-2**

Width	Hole	Length	Bend
17	Φ12	64	



**BK059-3**

Width	Hole	Length	Bend
19	Φ12	68	

**BK059-4**

Width	Hole	Length	Bend
19	Φ12	68	

**BK059-5**

Width	Hole	Length	Bend
Φ19	Φ12	72	

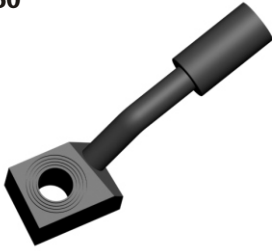
**BK060**

Width	Hole	Length	Bend
20	Φ11	85	

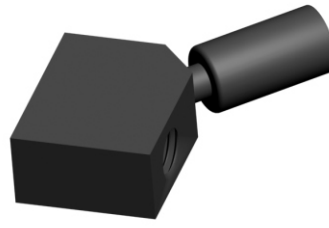
**BK061**

Width	Hole	Length	Bend
25	Φ10	63	45°

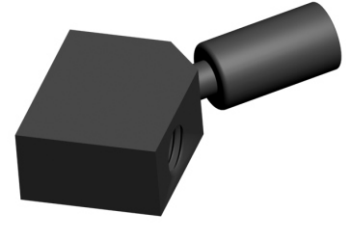
**BK061-2**

Width	Hole	Length	Bend
22	Φ10	63	45°

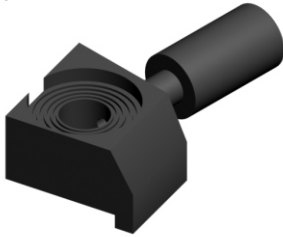
**BK062**

Width	Hole	Length	Bend
29	Φ10	62	

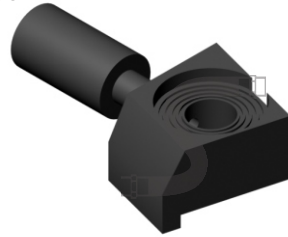
**BK062B**

Width	Hole	Length	Bend
29	Φ10	62	

**BK063**

Width	Hole	Length	Bend
25	Φ10	160	

**BK063B**

Width	Hole	Length	Bend
25	Φ10	160	

**BK064**

Width	Hole	Length	Bend
20	Φ11	110	

**BK064B**

Width	Hole	Length	Bend
20	Φ11	110	

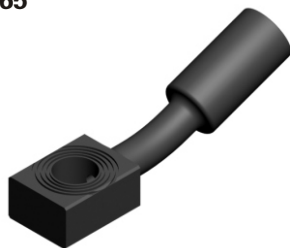
**BK065**

Width	Hole	Length	Bend
17	Φ10	70	20°

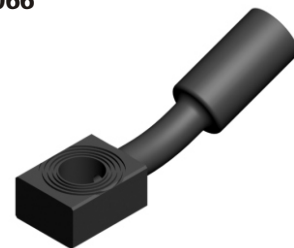
**BK066**

Width	Hole	Length	Bend
19	Φ10	79	

**BK067**

Width	Hole	Length	Bend
20	Φ10	110	

**BK067B**

Width	Hole	Length	Bend
20	Φ10	110	

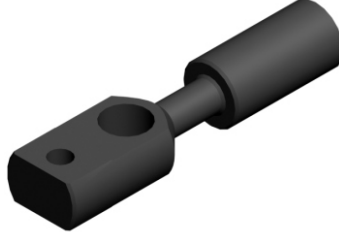
**BK068**

Width	Hole	Length	Bend
17	Φ10	57	

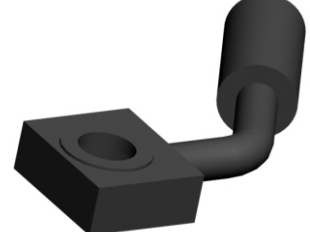
**BK069**

Width	Hole	Length	Bend
24	Φ10	90	

**BK070**

Width	Hole	Length	Bend
17	Φ12	80	30°

**BK070-2**

Width	Hole	Length	Bend
17	Φ10	80	12°

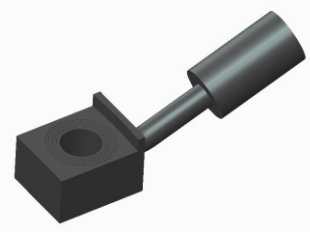
**BK071**

Width	Hole	Length	Bend
20	Φ10	71	30°

**BK072**

Width	Hole	Length	Bend
17	Φ10	120	

**BK073**

Width	Hole	Length	Bend
22	Φ10	125	

**BK074**

Width	Hole	Length	Bend
19.5	Φ10.2		

**BK074B**

Width	Hole	Length	Bend
19.5	Φ10.2		

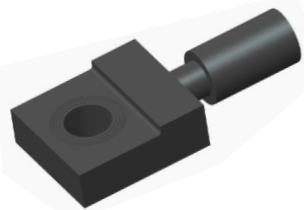
**BK075**

Width	Hole	Length	Bend
22.5	Φ10	65	62.5

**BK076**

Width	Hole	Length	Bend
22	Φ10	112	

**BK076B**

Width	Hole	Length	Bend
22	Φ10	112	

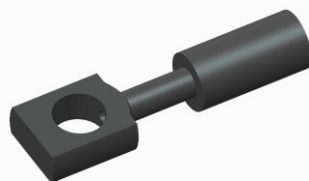
**BK077**

Width	Hole	Length	Bend
19	Φ12	67	

**BK078**

Width	Hole	Length	Bend
22	Φ10	85	65°

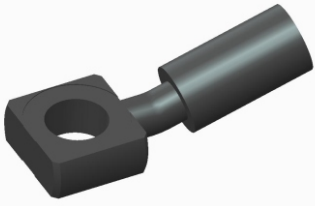
**BK079**

Width	Hole	Length	Bend
22	Φ12	56	15°

**BK080**

Width	Hole	Length	Bend
23	Φ10	107	100°

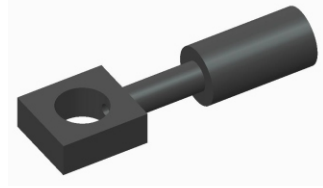
**BK081**

Width	Hole	Length	Bend
19	Φ12	65	

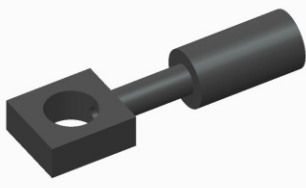
**BK081-2**

Width	Hole	Length	Bend
16	Φ10	57	

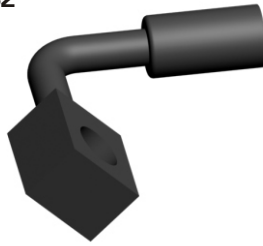
**BK082**

Width	Hole	Length	Bend
19	Φ10	100	90°

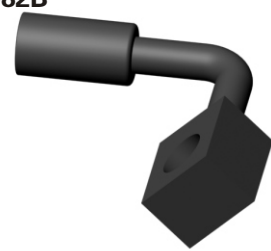
**BK082B**

Width	Hole	Length	Bend
19	Φ10	100	90°

**BK083**

Width	Hole	Length	Bend
25	Φ11	165	

**BK083B**

Width	Hole	Length	Bend
25	Φ11	165	

**BK084**

Width	Hole	Length	Bend
20.5	Φ10	185	

**BK085**

Width	Hole	Length	Bend
19	Φ10	145	

**BK086**

Width	Hole	Length	Bend
22	Φ10	104	

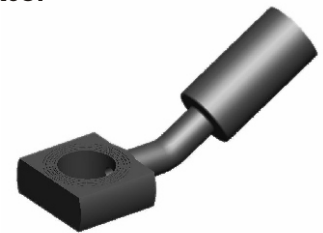
**BK087**

Width	Hole	Length	Bend
22	Φ12	65	30°

**BK088**

Width	Hole	Length	Bend
22.5	Φ10	71	

**BK088B**

Width	Hole	Length	Bend
	Φ10.2		50°

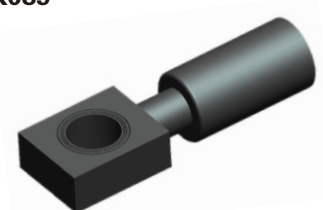
**BK089**

Width	Hole	Length	Bend
17	Φ10	54	

**BK090**

Width	Hole	Length	Bend
20	Φ10	55	80°

**BK091**

Width	Hole	Length	Bend
16	Φ10	69	30°

**BK091B**

Width	Hole	Length	Bend
16	Φ10	69	30°

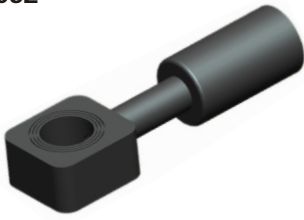
**BK092**

Width	Hole	Length	Bend
16	Φ10	57	

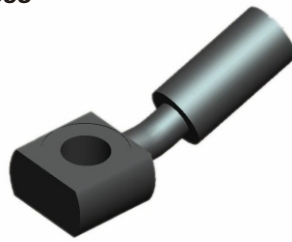
**BK093**

Width	Hole	Length	Bend
22	Φ10	62	20°

**BK094**

Width	Hole	Length	Bend
19.5	Φ10		25°

**BK094B**

Width	Hole	Length	Bend
19.5	Φ10		25°

**BK095**

Width	Hole	Length	Bend
22	Φ10		127°

**BK095B**

Width	Hole	Length	Bend
22	Φ10		127°

**BK096**

Width	Hole	Length	Bend
18	Φ10		87°

**BK097**

Width	Hole	Length	Bend
28.58	Φ11.9		127°

**BK098**

Width	Hole	Length	Bend
38.1	Φ12.1		115°

**BK099**

Width	Hole	Length	Bend
23	Φ10		70°

**BK100**

Width	Hole	Length	Bend
23	Φ10		70°

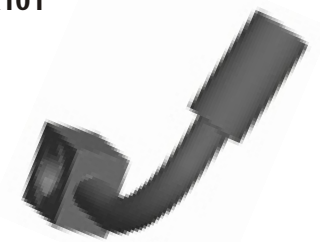
**BK101**

Width	Hole	Length	Bend
18	Φ10	71	70°

**BK102**

Width	Hole	Length	Bend
18	Φ 10		70°

**BK103**

Width	Hole	Length	Bend
18	Φ 10		80°

**BK104**

Width	Hole	Length	Bend
18	Φ 10.2	71	90°

**BK105**

Width	Hole	Length	Bend
18	Φ 10.2	68.25	90°

**BK106**

Width	Hole	Length	Bend
Φ 20	Φ 10		15°

**BK107**

Width	Hole	Length	Bend
20.5	Φ 10		130°

**BK108**

Width	Hole	Length	Bend
24	Φ 11		

**BK108B**

Width	Hole	Length	Bend
24	Φ 11		

**BK109**

Width	Hole	Length	Bend
20	Φ 10		15°

**BK110**

Width	Hole	Length	Bend
25.5	Φ 11.3		

**BK111**

Width	Hole	Length	Bend
25.5	Φ 11.3		

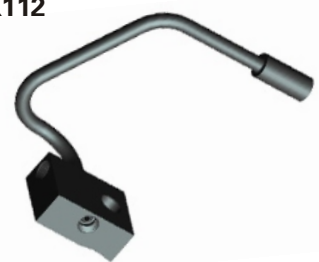
**BK112**

Width	Hole	Length	Bend

**BK113**

Width	Hole	Length	Bend
25.5	Φ 10		

**BK114**

Width	Hole	Length	Bend
H19			

**BK115**

Width	Hole	Length	Bend
20	Φ 9.5		15°

**BK116**

Width	Hole	Length	Bend
H17			

**BK117**

Width	Hole	Length	Bend
H19	Φ12		90°

**BK117B**

Width	Hole	Length	Bend
H19	Φ12		90°

**BK118**

Width	Hole	Length	Bend
20	Φ10		15°

**BK119**

Width	Hole	Length	Bend
H17			

**BK120**

Width	Hole	Length	Bend
32.6	Φ10		

**BK121**

Width	Hole	Length	Bend
18	Φ10		90°

**BK122**

Width	Hole	Length	Bend
20.8	Φ10		

**BK123**

Width	Hole	Length	Bend
20	Φ10		90°

**BK124**

Width	Hole	Length	Bend
19.5	Φ10		115°

**BK125**

Width	Hole	Length	Bend
19	Φ10		160°

**BK126**

Width	Hole	Length	Bend
H24	Φ10		90°

**BK127**

Width	Hole	Length	Bend
20	Φ10	61	

**BK128**

Width	Hole	Length	Bend
20.5	Φ11.2		95°

**BK128B**

Width	Hole	Length	Bend
20.5	Φ11.2		95°

**BK129**

Width	Hole	Length	Bend
Φ 18.1	Φ 10.2	63.5	

**BK130**

Width	Hole	Length	Bend
19.7	Φ 10.2		90°

**BK130B**

Width	Hole	Length	Bend
19.7	Φ 10.2		90°

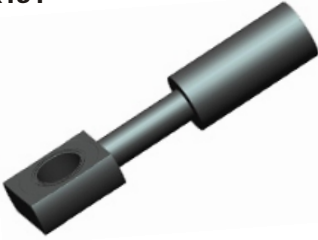
**BK131**

Width	Hole	Length	Bend
Φ 17	Φ 10.2	72	

**BK132**

Width	Hole	Length	Bend
Φ 17	Φ 10.2	86	45°

**BK133**

Width	Hole	Length	Bend
Φ 17	Φ 10.2	86	45°

**BK134**

Width	Hole	Length	Bend
Φ 17	Φ 10.2	86	45°

**BK135**

Width	Hole	Length	Bend
Φ 22	Φ 10.2		20°

**BK136**

Width	Hole	Length	Bend
Φ 19	Φ 10.2		40°

**BK136B**

Width	Hole	Length	Bend
Φ 19	Φ 10.2		40°

**BK137**

Width	Hole	Length	Bend
21.5	Φ 10.2		150°

**BK137B**

Width	Hole	Length	Bend
21.5	Φ 10.2		150°

**BK138**

Width	Hole	Length	Bend
21.5	Φ 10.2		100°

**BK138B**

Width	Hole	Length	Bend
21.5	Φ 10.2		100°

**BK139**

Width	Hole	Length	Bend
19.5	Φ 10.2		135°

**BK139B**

Width	Hole	Length	Bend
19.5	Φ 10.2		135°

**BK140**

Width	Hole	Length	Bend
19.5	Φ 10.2		105°

**BK141**

Width	Hole	Length	Bend
Φ 26	Φ 10.2		135°

**BK141B**

Width	Hole	Length	Bend
Φ 26	Φ 10.2		135°

**BK142**

Width	Hole	Length	Bend
	Φ 10.2		135°

**BK142B**

Width	Hole	Length	Bend
	Φ 10.2		135°

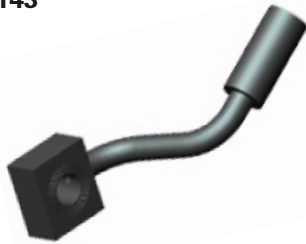
**BK143**

Width	Hole	Length	Bend
25.3	Φ 10.2		

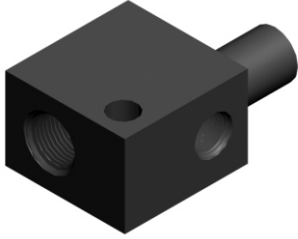

**BL001**

Width	Hole	Thread
31	Φ8.5	M14X1.5--M10X1

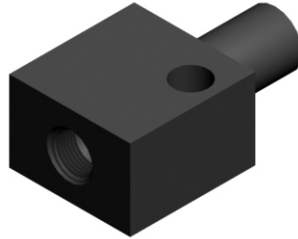
**BL002**

Width	Hole	Thread
30	Φ8.5	M14X1.5--M10X1

**BL002-2**

Width	Hole	Thread
35	Φ8.5	1/2X20--M10X1

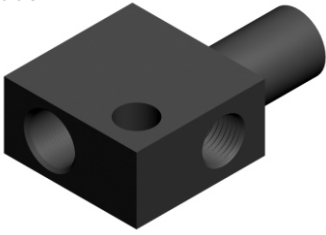
**BL003**

Width	Hole	Thread
31	Φ8.5	M12X1--M10X1

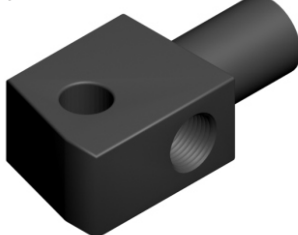
**BL004**

Width	Hole	Thread
25	Φ10	M10X1--M10X1

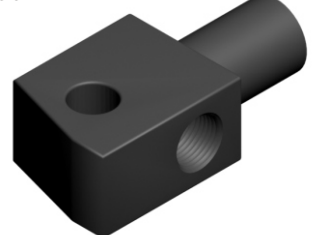
**BL004-2**

Width	Hole	Thread
25	Φ8	M10X1--M10X1

**BL004-3**

Width	Hole	Thread
25	Φ8.5	M10X1--M10X1

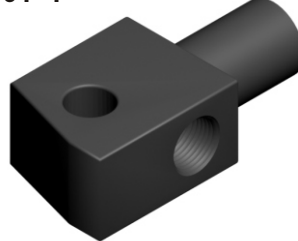
**BL004-4**

Width	Hole	Thread
25	Φ8.5	M10X1--M10X1(L49.5)

**BL004-5**

Width	Hole	Thread
16	Φ9	M10X1

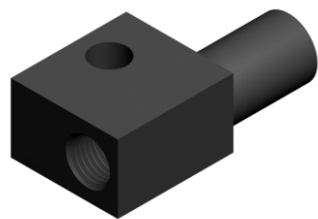
**BL005**

Width	Hole	Thread
25	Φ8	M10X1(120°)

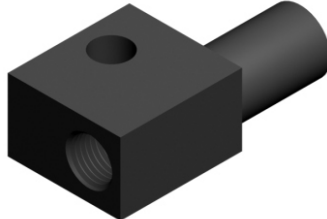
**BL005-2**

Width	Hole	Thread
25	Φ8	M10X1(84°)

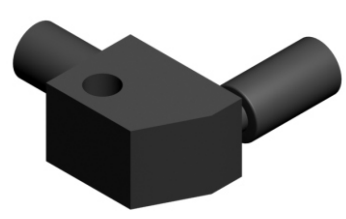
**BL006**

Width	Hole	Thread
	Φ8.5	

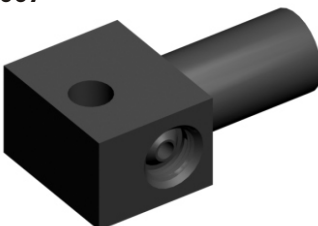
**BL007**

Width	Hole	Thread
31	Φ8.5	3/8X24--3/8X24

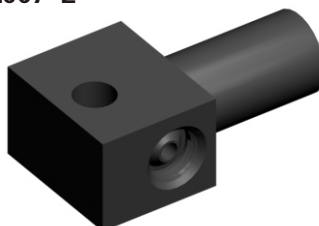
**BL007-2**

Width	Hole	Thread
25	Φ8.5	3/8X24--3/8X24

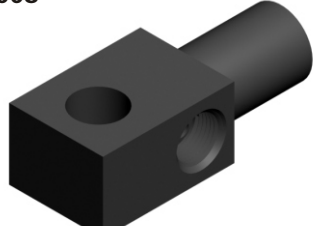
**BL008**

Width	Hole	Thread
20	Φ10	3/8X24--3/8X24

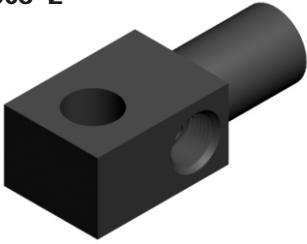
**BL008-2**

Width	Hole	Thread
20	Φ11	3/8X24--3/8X24

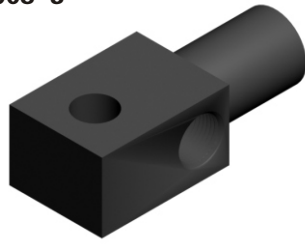
**BL008-3**

Width	Hole	Thread
20	Φ8	3/8X24--3/8X24

**BL009**

Width	Hole	Thread
20	Φ8.5	3/8X24--3/8X24

**BL009-2**

Width	Hole	Thread
15	Φ10	3/8X24--3/8X24

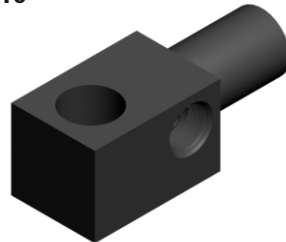
**BL010**

Width	Hole	Thread
20	Φ12	3/8X24--3/8X24

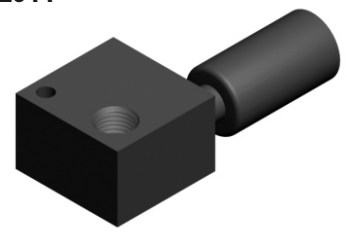
**BL011**

Width	Hole	Thread
25	Φ3.5	M8--M10X1

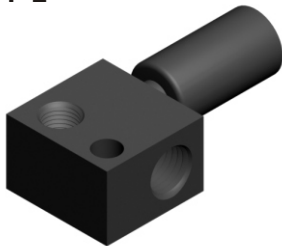
**BL011-2**

Width	Hole	Thread
25	Φ6	M8--M10X1

**BL011-2(Bottom)**

Width	Hole	Thread
25	Φ6	M8--M10X1

**BL012**

Width	Hole	Thread
25.5	Φ8	M10X1--M10X1

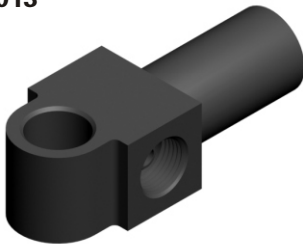
**BL013**

Width	Hole	Thread
20.5	Φ10	3/8X24--3/8X24

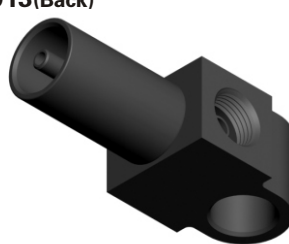
**BL013(Back)**

Width	Hole	Thread
20.5	Φ10	3/8X24--3/8X24

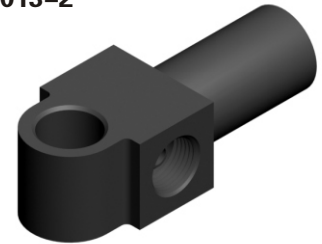
**BL013-2**

Width	Hole	Thread
20.5	Φ8	3/8X24--3/8X24

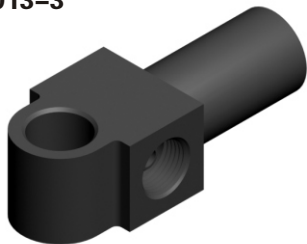
**BL013-3**

Width	Hole	Thread
20.5	Φ10	7/16X24--7/16X24

**BL014**

Width	Hole	Thread
19	Φ10	3/8X24--3/8X24

**BL014-2**

Width	Hole	Thread
25		3/8X24--3/8X24

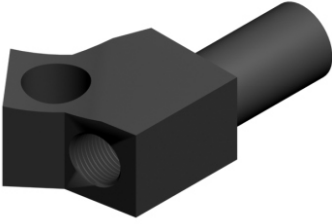
**BL015**

Width	Hole	Thread
33	11.5	3/8X24--3/8X24

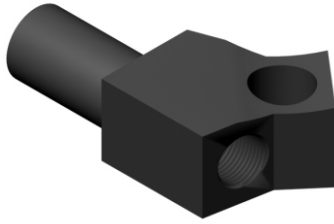
**BL015B**

Width	Hole	Thread
33	11.5	3/8X24--3/8X24

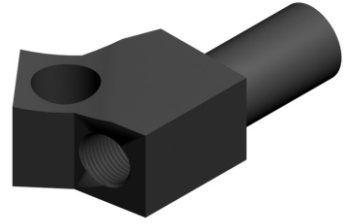
**BL015-2**

Width	Hole	Thread
33	11.5	3/8X24--7/16X24

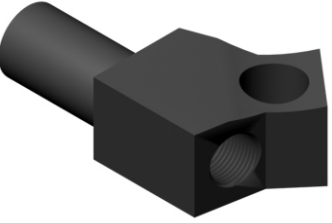
**BL015-2B**

Width	Hole	Thread
33	11.5	3/8X24--7/16X24

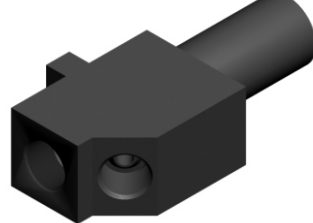
**BL016**

Width	Hole	Thread
24		3/8X24--3/8X24

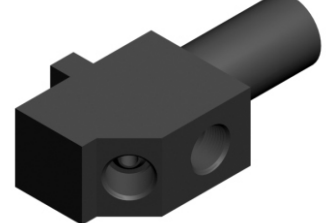
**BL016-2**

Width	Hole	Thread
24		3/8X24--3/8X24

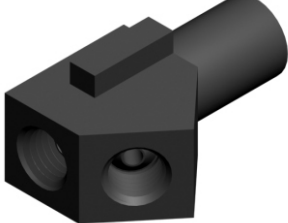
**BL017**

Width	Hole	Thread
28		3/8X24--3/8X24

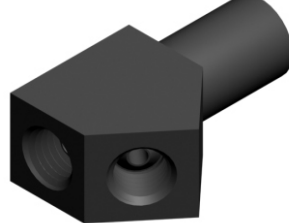
**BL017-2**

Width	Hole	Thread
28		3/8X24--3/8X24

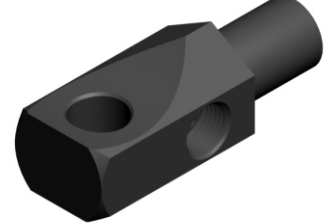
**BL018**

Width	Hole	Thread
21	Φ11.5	M10X1--M10X1

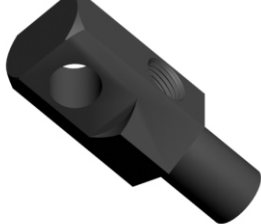
**BL018(Bottom)**

Width	Hole	Thread
21	Φ11.5	3/8X24--3/8X24

**BL018-2**

Width	Hole	Thread
H21	Φ11.2	3/8X24--3/8X24

**BL019**

Width	Hole	Thread
29	Φ7	M10X1--M10X1

**BL020**

Width	Hole	Thread
21	Φ3.5	M8--M10X1

**BL020(Bottom)**

Width	Hole	Thread
25	Φ6	2-M10X1--M8

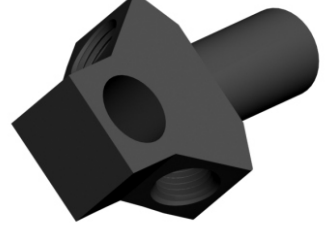
**BL021**

Width	Hole	Thread
30	Φ11.5	3/8X24--3/8X24

**BL021-2**

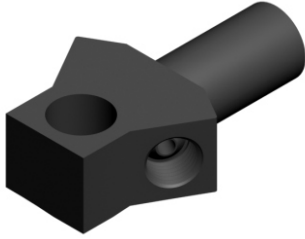

Width	Hole	Thread
30	Φ11.5	3/8X24--3/8X24

**BL021-3**

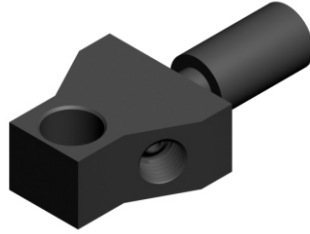

Width	Hole	Thread
32	Φ12	3/8X24--3/8X24

**BL021-4**

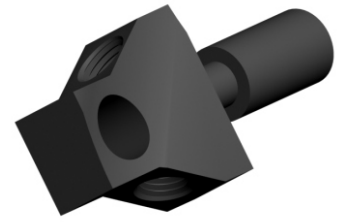

Width	Hole	Thread
32	Φ12	3/8X24--3/8X24

**BL021-5**

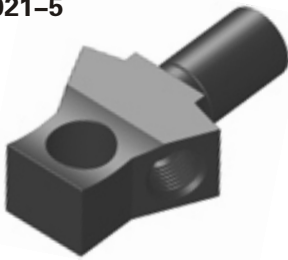

Width	Hole	Thread
18	Φ12	3/8X24--3/8X24

**BL022**

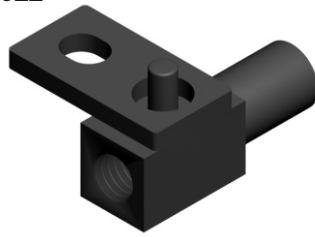

Width	Hole	Thread
16	Φ8	M10X1

**BL022B**

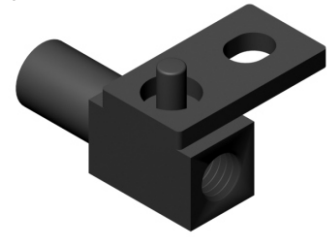

Width	Hole	Thread
16	Φ8	M10X1

**BL023**

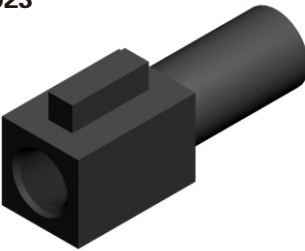

Width	Hole	Thread
16		3/8X24

**BL023-2**

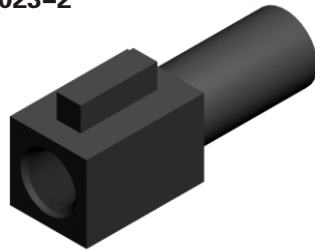

Width	Hole	Thread
16		M12X1

**BL023-3**

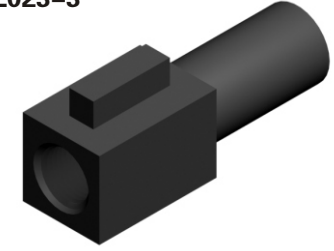

Width	Hole	Thread
16		7/16X24

**BL024**



Width	Hole	Thread
15	Φ8	M10X1(1204° )

**BL024-2**



Width	Hole	Thread
15	Φ8	M10X1(84° )

**BL025**

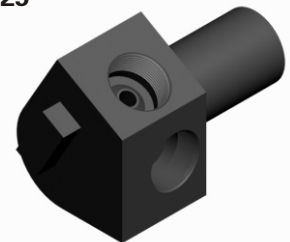

Width	Hole	Thread
23	Φ8	7/16X24--7/16X24

**BL025-2**

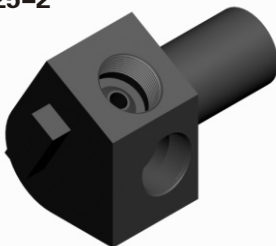

Width	Hole	Thread
23		3/8X24--3/8X24

**BL025-3**

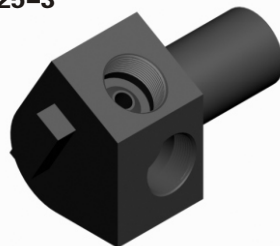

Width	Hole	Thread
16		M10X1

**BL025-4**

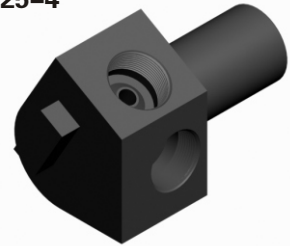

Width	Hole	Thread
16		3/8X24

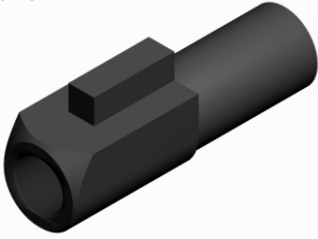
**BL026**

Width	Hole	Thread
15		M10X1

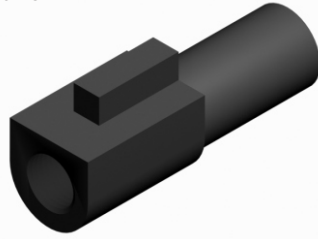
**BL026-2**

Width	Hole	Thread
16		7/16X24

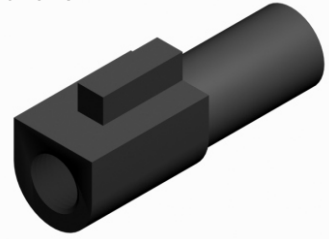
**BL026-3**

Width	Hole	Thread
16		M10X1

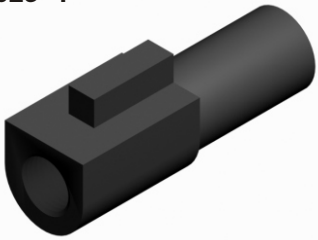
**BL026-4**

Width	Hole	Thread
16		3/8X24

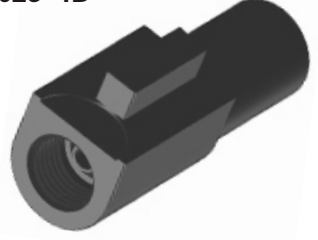
**BL026-4B**

Width	Hole	Thread
16		3/8X24

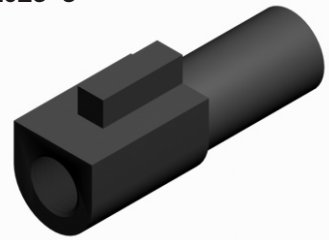
**BL026-5**

Width	Hole	Thread
15		3/8X24

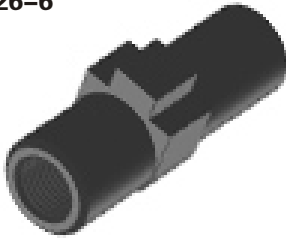
**BL026-6**

Width	Hole	Thread
∅ 16		M10X1

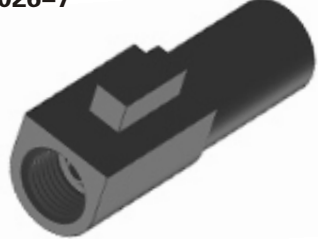
**BL026-7**

Width	Hole	Thread
15		3/8X24

**BL027**

Width	Hole	Thread
15	5	M10X1

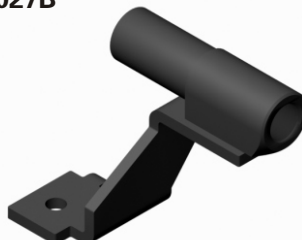
**BL027B**

Width	Hole	Thread
15	5	M10X1

**BL028**

Width	Hole	Thread
16	9	3/8X24

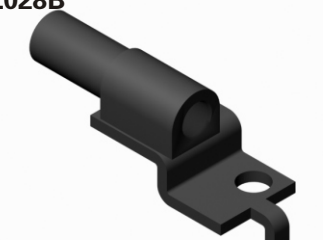
**BL028B**

Width	Hole	Thread
16	9	3/8X24

**BL029**

Width	Hole	Thread
37		3/8X24--3/8X24

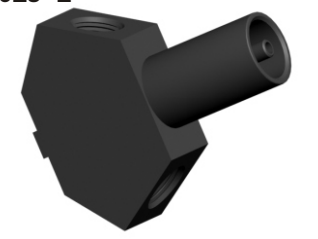
**BL029-2**

Width	Hole	Thread
31		3/8X24--3/8X24

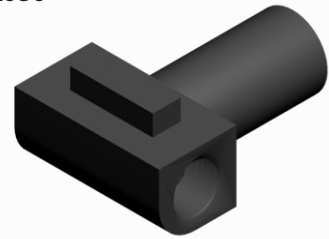
**BL030**

Width	Hole	Thread
28		3/8X24--3/8X24

**BL030-2**

Width	Hole	Thread
29		3/8X24--3/8X24

**BL031**

Width	Hole	Thread
31		3/8X24

**BL032**

Width	Hole	Thread
20	6.5	3/8X24

**BL032B**

Width	Hole	Thread
20	6.5	3/8X24

**BL033**

Width	Hole	Thread
20.5	Φ16	7/16X24--3/8X24

**BL033-2**

Width	Hole	Thread
20	Φ12.4	3/8X24--7/16X24

**BL034**

Width	Hole	Thread
20	Φ12	7/16X24--3/8X24

**BL034-2**

Width	Hole	Thread
20	Φ12	7/16X24--3/8X24

**BL034-3**

Width	Hole	Thread
21	Φ12	7/16X24--3/8X24

**BL035**

Width	Hole	Thread
20	Φ12	7/16X24--3/8X24

**BL036**

Width	Hole	Thread
24		3/8X24

**BL037**

Width	Hole	Thread
25	8.5	M10X1--M10X1

**BL037-2**

Width	Hole	Thread
25	Φ9	M10X1

**BL037-3**

Width	Hole	Thread
19	Φ11.4	3/8X24--3/8X24

**BL037-3B**

Width	Hole	Thread
19	Φ11.4	3/8X24--3/8X24

**BL037-4**

Width	Hole	Thread
20.5	Φ 11.4	3/8X24--3/8X24

**BL038**

Width	Hole	Thread
20	Φ 12.5	7/16X24--3/8X24

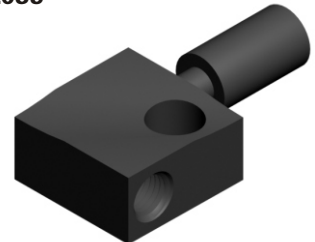
**BL039**

Width	Hole	Thread
32	Φ 12	3/8X24--3/8X24

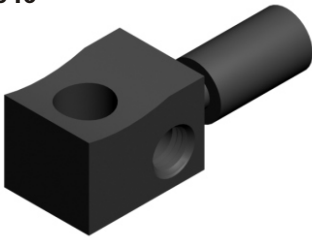
**BL040**

Width	Hole	Thread
22	Φ 12	3/8X24--3/8X24

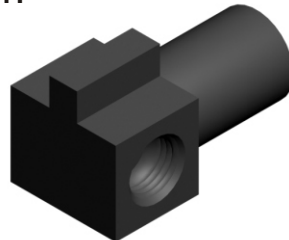
**BL041**

Width	Hole	Thread
19		3/8X24

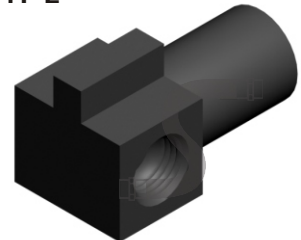
**BL041-2**

Width	Hole	Thread
19		M10X1

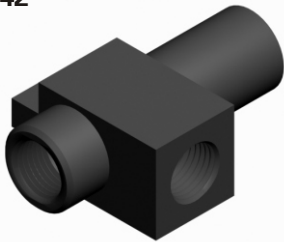
**BL042**

Width	Hole	Thread
24		M10X1--M10X1

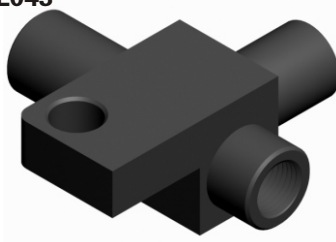
**BL043**

Width	Hole	Thread
9		M10X1--M10X1

**BL044**

Width	Hole	Thread
25		3/8X24--3/8X24

**BL045**

Width	Hole	Thread
25		3--M10X1

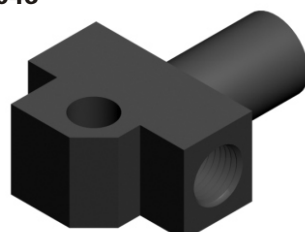
**BL046**

Width	Hole	Thread
32	Φ 8	M10X1--M10X1

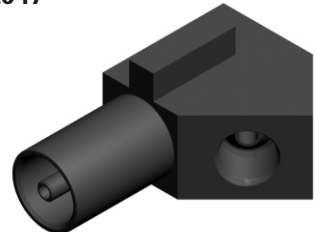
**BL047**

Width	Hole	Thread
29		3/8X24

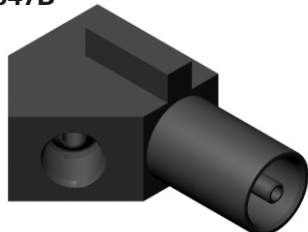
**BL047B**

Width	Hole	Thread
29		3/8X24

**BL048**

Width	Hole	Thread
26		3/8X24--3/8X24

**BL049**

Width	Hole	Thread
16		7/16X24

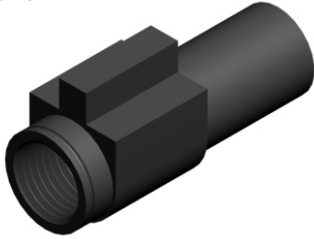
**BL049-2**

Width	Hole	Thread
16		3/8X24

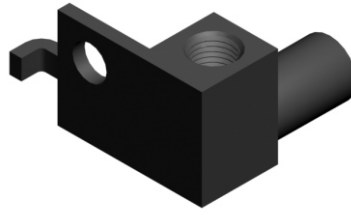
**BL050**

Width	Hole	Thread
25	8.5	M10X1

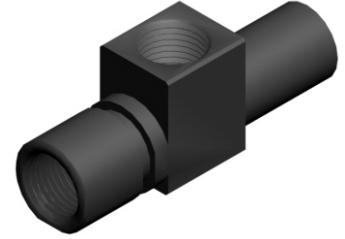
**BL051**

Width	Hole	Thread
21.5		M12X1--M12X1

**BL052**

Width	Length	Thread
25.5	52	3/8X24--3/8X24

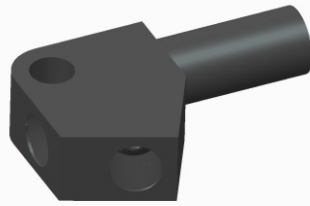
**BL053**

Length	Hole	Thread
60	12	3/8X24--3/8X24

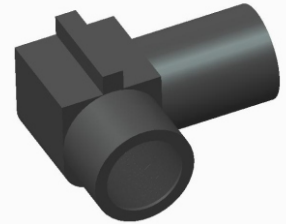
**BL054**

Length	Hole	Thread
35		M10X1

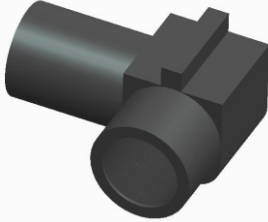
**BL054B**

Length	Hole	Thread
35		M10X1

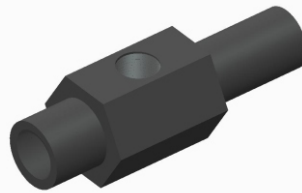
**BL055**

Length	Hole	Thread
63	21	3/8X24

**BL055-2**

Length	Hole	Thread
63	21	3/8X24

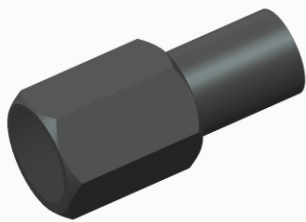
**BL056**

Length	Hole	Thread
45	19	M14X1.5

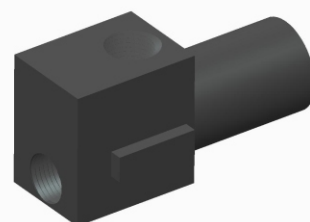
**BL057**

Length	Hole	Thread
41		3/8X24--3/8X24

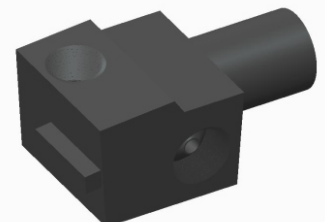
**BL058**

Width	Hole	Thread
25		3/8X24--3/8X24

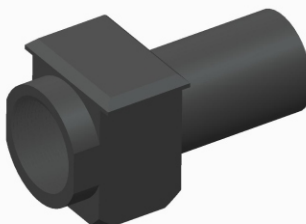
**BL059**

Width	Length	Thread
24.5	41	1/2x20

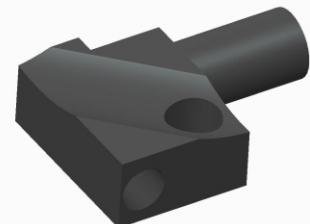
**BL060**

Width	Length	Thread
31.5	54.5	3/8X24--3/8X24

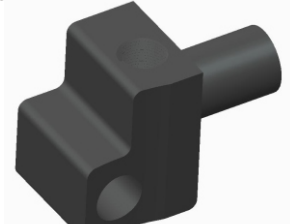
**BL061**

Width	Hole	Thread
27	Φ11.5	3/8X24--3/8X24

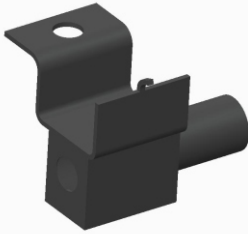

**BL062**

Width	Length	Thread
16	47	3/8X24

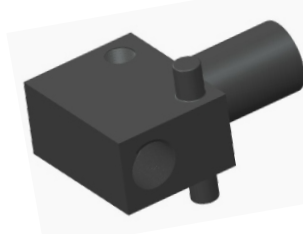
**BL063**

Width	Length	Thread
30	49.5	M10X1--M8X1.25

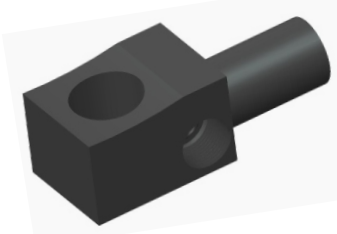
**BL064**

Width	Hole	Thread
22.5	Φ 12	3/8X24--3/8X24(L51)

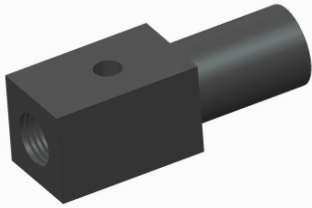
**BL065**

Width	Length	Thread
16	47	M10X1

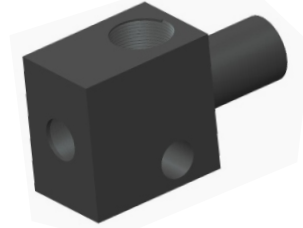
**BL066**

Width	Length	Thread
30	55	M10X1--M14X1.5

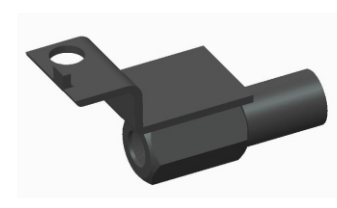
**BL067**

Length	Width	Thread
47	16	3/8X24

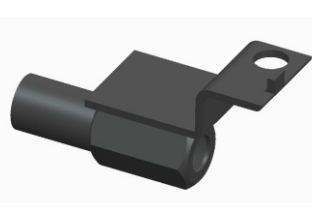
**BL067B**

Length	Width	Thread
47	16	3/8X24

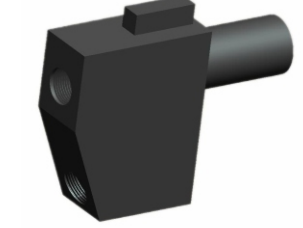
**BL068**

Width	Length	Thread
40	60	3/8X24

**BL069**

Width	Length	Thread
31	46	3/8X24

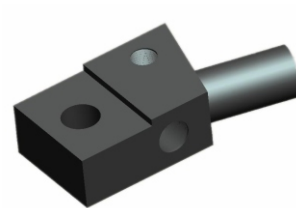
**BL070**

Length	Hole	Thread
70	10	M10X1--M8X1.25

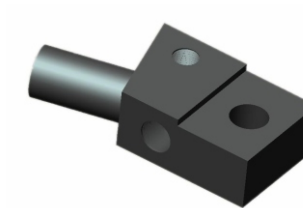
**BL070B**

Length	Hole	Thread
70	10	M10X1--M8X1.25

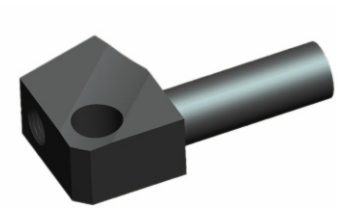
**BL071**

Length	Hole	Thread
66	Φ 12	3/8X24--3/8X24

**BL071-2**

Length	Hole	Thread
66	Φ 12	3/8X24--3/8X24

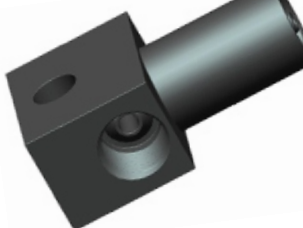
**BL072**

Length	Hole	Thread
25.4	Φ 7	3/8X24--3/8X24

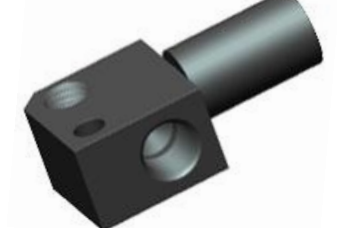
**BL073**

Width	Hole	Thread
25.2	Φ 5.5	M8X1.25--M10X1

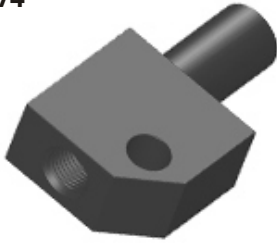
**BL074**

Width	Hole	Thread
32	Φ 8.6	M10X1--M10X1

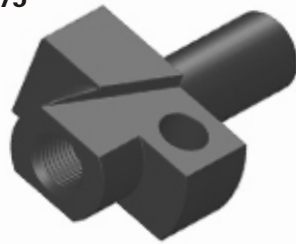
**BL075**

Width	Hole	Thread
35.7	Φ 8.2	M10X1--M10X1

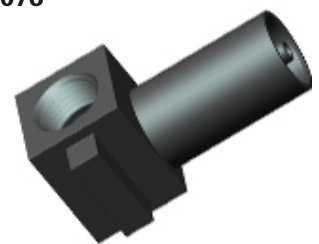
**BL076**

Width	Hole	Thread
20		3/8X24

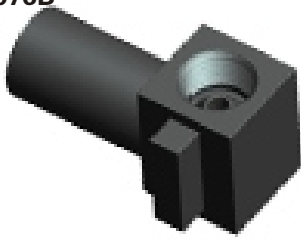
**BL076B**

Width	Hole	Thread
20		3/8X24

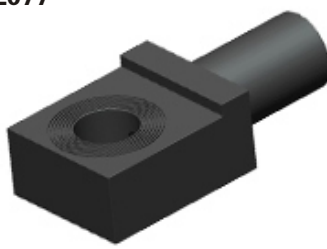
**BL077**

Width	Hole	Thread
24.9	Φ 11	

**BL078**

Width	Hole	Thread
35.7	Φ 8.2	M10X1--M10X1

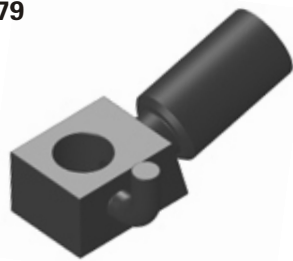
**BL079**

Width	Hole	Thread
17	Φ 10	

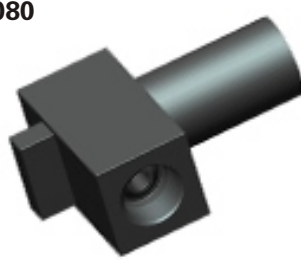
**BL080**

Width	Hole	Thread
31.12		3/8X24

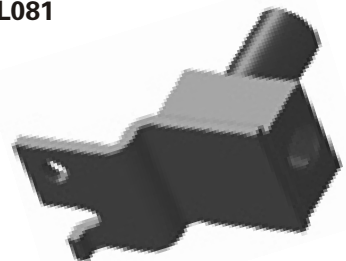
**BL081**

Width	Hole	Thread
56	Φ 6	M10X1

**BL082**

Width	Hole	Thread
16		M12X1

**BL083**

Width	Hole	Thread
16.5		7/16X24

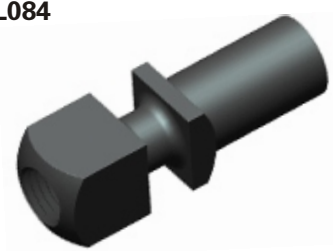
**BL084**

Width	Hole	Thread
15		M10X1.25

**BL085**

Width	Hole	Thread
16		M12X1

**BL086**

Width	Hole	Thread
16.5		7/16X24

**BL087**

Width	Hole	Thread
15		M10X1.25

**BL088**

Width	Hole	Thread
32	Φ 8.6	M10X1--M10X1

**BL089**

Width	Hole	Thread
35.7	Φ 8.2	M10X1--M10X1

**BL090**



Width	Hole	Thread
42.5		3/8X24--M10X1

**FA001**

Thread	Seat	Length	Seal
M10X1	H19	33.5	84°

**FA001-2**

Thread	Seat	Length	Seal
M10X1	H19	33.5	120°

**FA001-3**

Thread	Seat	Length	Seal
M10X1	H19	34.2	84°

**FA002**

Thread	Seat	Length	Seal
3/8X24	H16	36	84°

**FA002-2**

Thread	Seat	Length	Seal
3/8X24	H16	36	84°

**FA002-3**

Thread	Seat	Length	Seal
7/16X24	H16	39.5	84°

**FA003**

Thread	Seat	Length	Seal
3/8X24	H16	35	84°

**FA004**

Thread	Seat	Length	Seal
3/8X24	H16	38	84°

**FA004-2**

Thread	Seat	Length	Seal
3/8X24	H17	38	84°

**FA004-3**

Thread	Seat	Length	Seal
3/8X24	H16	38.2	84°

**FA004-4**

Thread	Seat	Length	Seal
3/8X24	H16	41	84°

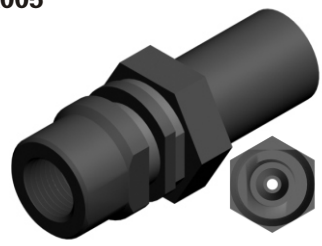
**FA005**

Thread	Seat	Length	Seal
3/8X24	H18	45	84°

**FA006**

Thread	Seat	Length	Seal
7/16X24	H16	45	84°

**FA006-2**

Thread	Seat	Length	Seal
M10X1	H16	45	84°

**FA006-3**

Thread	Seat	Length	Seal
7/16X24	H16	45.6	84°

**FA006-4**

Thread	Seat	Length	Seal
7/16X24	H16	44.1	84°

**FA007**

Thread	Seat	Length	Seal
3/8X24	H16	40	84°

**FA008**

Thread	Seat	Length	Seal
3/8X24	H16	33	84°

**FA009**

Thread	Seat	Length	Seal
M10X1	H16	42	84°

**FA009-2**

Thread	Seat	Length	Seal
M10X1	H16	42	120°

**FA010**

Thread	Seat	Length	Seal
1/2X20	H19	37	84°

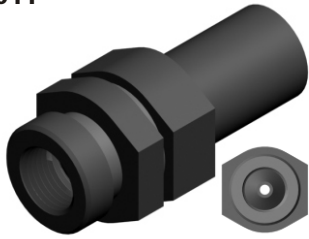
**FA011**

Thread	Seat	Length	Seal
3/8X24	H17	39	84°

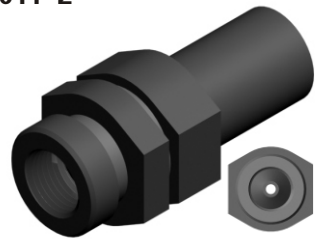
**FA011-2**

Thread	Seat	Length	Seal
3/8X24	H17	39	84°

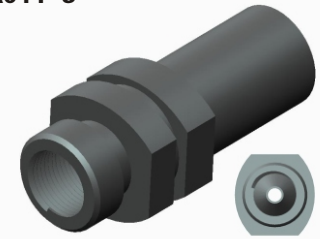
**FA011-3**

Thread	Seat	Length	Seal
3/8X24	H16	39	84°

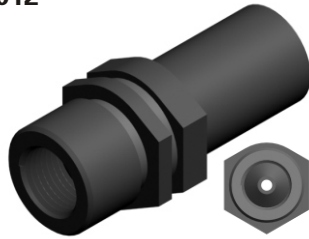
**FA012**

Thread	Seat	Length	Seal
M10X1	H17	40	84°

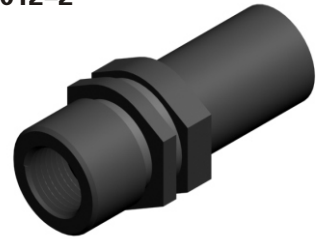
**FA012-2**

Thread	Seat	Length	Seal
3/8X24	H16	45	84°

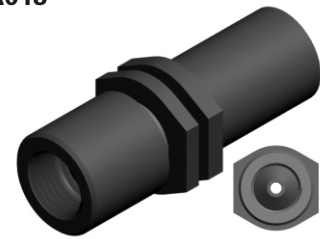
**FA013**

Thread	Seat	Length	Seal
M10X1	H17	42.5	84°

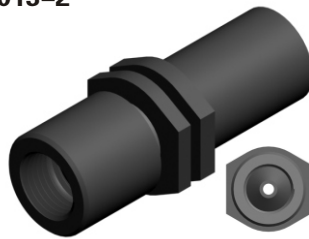
**FA013-2**

Thread	Seat	Length	Seal
7/16X24	H16	46	84°

**FA013-3**

Thread	Seat	Length	Seal
M10X1	H17	46	84°

**FA014**

Thread	Seat	Length	Seal
M12X1	H19	44	84°

**FA015**

Thread	Seat	Length	Seal
M10X1	H17	43	84°

**FA015-2**

Thread	Seat	Length	Seal
M10X1	H17	43	84°

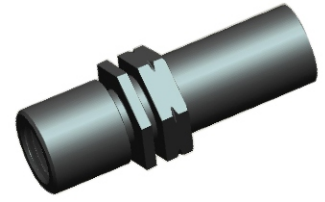
**FA015-3**

Thread	Seat	Length	Seal
M10X1	H17	48.8	84°

**FA016**

Thread	Seat	Length	Seal
7/16X24	H16	43	84°

**FA017**

Thread	Seat	Length	Seal
3/8X24	H17	44	84°

**FA017-2**

Thread	Seat	Length	Seal
3/8X24	H16	44	84°

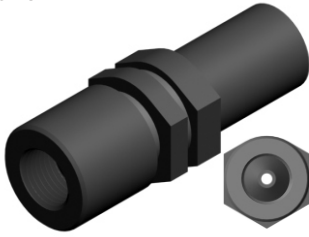
**FA018**

Thread	Seat	Length	Seal
M12X1	H17	47	84°

**FA019**

Thread	Seat	Length	Seal
3/8X24	H16	38	84°

**FA019-2**

Thread	Seat	Length	Seal
7/16X24	H16	38	84°

**FA019-3**

Thread	Seat	Length	Seal
3/8X24	H17	41.4	84°

**FA020**

Thread	Seat	Length	Seal
M10X1	Φ23	35	84°

**FA021**

Thread	Seat	Length	Seal
M10X1	Φ23	35	120°

**FA022**

Thread	Seat	Length	Seal
M10X1	Φ23	35	84°

**FA023**

Thread	Seat	Length	Seal
3/8X24	H16	46	84°

**FA024**

Thread	Seat	Length	Seal
M10X1	H17	33	84°

**FA024-2**

Thread	Seat	Length	Seal
M10X1	H19	33	84°

**FA025**

Thread	Seat	Length	Seal
3/8X24	H16	46	84°

**FA026**

Thread	Seat	Length	Seal
M10X1	Φ23	34	84°

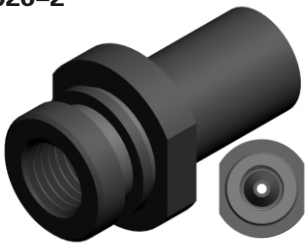
**FA026-2**

Thread	Seat	Length	Seal
M10X1	Φ22	34	84°

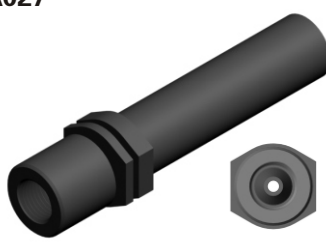
**FA027**

Thread	Seat	Length	Seal
M10X1	H17	74	84°

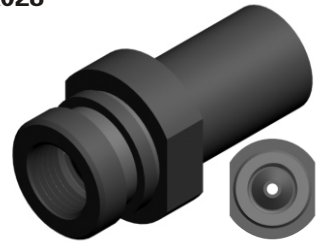
**FA028**

Thread	Seat	Length	Seal
M10X1	Φ20	36	84°

**FA029**

Thread	Seat	Length	Seal
M10X1	Φ20	36	120°

**FA030**

Thread	Seat	Length	Seal
M10X1	Φ23	34	120°

**FA031**

Thread	Seat	Length	Seal
M10X1	H17	36	84°

**FA031-2**

Thread	Seat	Length	Seal
3/8X24	H17	36	84°

**FA031-3**

Thread	Seat	Length	Seal
M10X1.25	H17	33.5	84°

**FA032**

Thread	Seat	Length	Seal
3/8X24	H16	45	84°

**FA033**

Thread	Seat	Length	Seal
7/16X24	H17	46	84°

**FA033-2**

Thread	Seat	Length	Seal
3/8X24	H16	46	84°

**FA033-3**

Thread	Seat	Length	Seal
7/16X24	H17	44.7	84°

**FA033-4**

Thread	Seat	Length	Seal
7/16X24	H17.2	45.6	84°

**FA034**

Thread	Seat	Length	Seal
M10X1	H17	40	84°

**FA034-2**

Thread	Seat	Length	Seal
3/8X24	H17	40	84°

**FA035**

Thread	Seat	Length	Seal
M10X1	H16	41	84°

**FA036**

Thread	Seat	Length	Seal
7/16X24	H16	38	84°

**FA036-2**

Thread	Seat	Length	Seal
7/16X24	H18	42	84°

**FA036-3**

Thread	Seat	Length	Seal
3/8X24	H18	42.8	84°

**FA036-4**

Thread	Seat	Length	Seal
7/16X24	H17.5	49.6	84°

**FA037**

Thread	Seat	Length	Seal
M12X1	H19	43	120°

**FA038**

Thread	Seat	Length	Seal
M10X1	Φ24	36	84°

**FA039**

Thread	Seat	Length	Seal
M10X1	H19	33.5	120°

**FA039-2**

Thread	Seat	Length	Seal
M10X1	H16	35.5	120°

**FA040**

Thread	Seat	Length	Seal
M10X1	H16	35	120°

**FA041**

Thread	Seat	Length	Seal
3/8X24	H16	38	84°

**FA041-2**

Thread	Seat	Length	Seal
7/16X24	H17.5	38	84°



**FA041-3**

Thread	Seat	Length	Seal
3/8X24	H16	40.7	84°

**FA042**

Thread	Seat	Length	Seal
3/8X24	H16	38	84°

**FA042-2**

Thread	Seat	Length	Seal
3/8X24	H16	38	84°

**FA043**

Thread	Seat	Length	Seal
3/8X24	H16	37	84°

**FA043-2**

Thread	Seat	Length	Seal
3/8X24	H16	40	84°

**FA043-3**

Thread	Seat	Length	Seal
3/8X24	H16	40.7	84°

**FA043-4**

Thread	Seat	Length	Seal
3/8X24	H16	41.3	84°

**FA044**

Thread	Seat	Length	Seal
3/8X24	H16	35.5	84°

**FA045**

Thread	Seat	Length	Seal
7/16X24	H16	45	84°

**FA045B**

Thread	Seat	Length	Seal
7/16X24	H16	44.6	84°

**FA045-2**

Thread	Seat	Length	Seal
3/8X24	H16	45	84°

**FA045-2B**

Thread	Seat	Length	Seal
M10X1	H16	37.7	120°

**FA046**

Thread	Seat	Length	Seal
7/16X24	H16	41	84°

**FA047**

Thread	Seat	Length	Seal
M10X1.25	H17	33.5	84°

**FA048**

Thread	Seat	Length	Seal
3/8X24	H17	41	84°

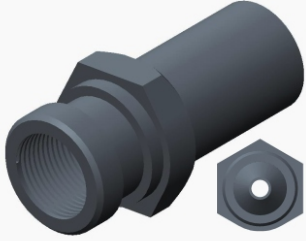
**FA049**

Thread	Seat	Length	Seal
M10X1	H16	38	84°

**FA049-2**

Thread	Seat	Length	Seal
M10X1	H19	35.6	120°

**FA049-3**

Thread	Seat	Length	Seal
M10X1	H19	33.7	84°

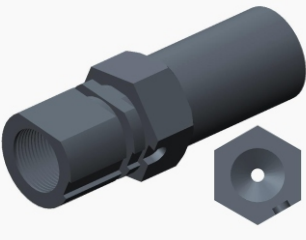
**FA050**

Thread	Seat	Length	Seal
M10X1	H17	49	120°

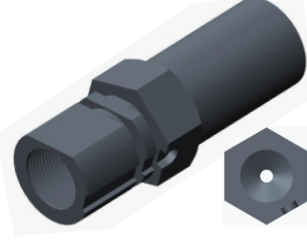
**FA051**

Thread	Seat	Length	Seal
M10X1	H16	38	120°

**FA051-2**

Thread	Seat	Length	Seal
3/8X24	H15.8	37.8	84°

**FA052**

Thread	Seat	Length	Seal
7/16X24	Φ19	46.5	84°

**FA053**

Thread	Seat	Length	Seal
7/16X24	H16	80	84°

**FA054**

**KST BRAKE HOSE**

Thread	Seat	Length	Seal
7/16X24	H16	44.5	84°

**FA055**

Thread	Seat	Length	Seal
3/8X24	H16	47.5	84°

**FA056**

Thread	Seat	Length	Seal
7/16X24	H16	45	84°

**FA056-2**

Thread	Seat	Length	Seal
7/16X24	H16	44.8	84°

**FA057**

Thread	Seat	Length	Seal
M10X1	H19	47	84°

**FA058**

Thread	Seat	Length	Seal
M10X1	H19	50	120°

**FA059**

Thread	Seat	Length	Seal
M10X1	H19	73	120°

**FA060**

Thread	Seat	Length	Seal
7/16X24	H16	80	84°

**FA061**

Thread	Seat	Length	Seal
M10X1	H16	45.2	120°

**FA062**

Thread	Seat	Length	Seal
M10X1	H16	45.08	120°

**FA063**

Thread	Seat	Length	Seal
3/8X24	H16	37	84°

**FA064**

Thread	Seat	Length	Seal
7/16X24	H16	44.7	84°

**FA065**

Thread	Seat	Length	Seal
3/8X24	H16	39.5	84°

**FA066**

Thread	Seat	Length	Seal
7/16X24	H16	45.4	84°

**FB001**

Thread	Seat	Length	Seal
M10X1	H17	39	84°

**FB001-2**

Thread	Seat	Length	Seal
M10X1	H16	39	84°

**FB002**

Thread	Seat	Length	Seal
M10X1	H17	36	120°

**FB003**

Thread	Seat	Length	Seal
M12X1	H19	45	84°

**FB004**

Thread	Seat	Length	Seal
M10X1	Φ20	39	120°

**FB004-2**

Thread	Seat	Length	Seal
M10X1	Φ18	39	120°

**FB005**

Thread	Seat	Length	Seal
M10X1	Φ17	39	120°

**FB006**

Thread	Seat	Length	Seal
M10X1	Φ17	39	120°

**FB007**

Thread	Seat	Length	Seal
M10X1	Φ17	37	120°

**FB007-2**

Thread	Seat	Length	Seal
M10X1	Φ19	37	120°

**FB008**

Thread	Seat	Length	Seal
M10X1	Φ18	39	120°

**FB008-2**

Thread	Seat	Length	Seal
M10X1	Φ20	39	120°

**FB008-3**

Thread	Seat	Length	Seal
3/8 x 24	Φ18	38	84°

**FB008-4**

Thread	Seat	Length	Seal
M10 x 1	Φ18	38	120°

**FB009**

Thread	Seat	Length	Seal
M10X1	Φ20	39	120°

**FB009-2**

Thread	Seat	Length	Seal
M10X1	Φ17	39	120°

**FB010**

Thread	Seat	Length	Seal
M10X1	Φ17	44	120°

**FB011**

Thread	Seat	Length	Seal
M10X1	H14	38	120°

**FB011-2**

Thread	Seat	Length	Seal
M10X1	H16	38	120°

**FB012**

Thread	Seat	Length	Seal
M10X1.25	H15	45	120°

**FB013**

Thread	Seat	Length	Seal
M10X1	H17	41	120°

**FB014**

Thread	Seat	Length	Seal
M10X1	H17	38	120°

**FB014-2**

Thread	Seat	Length	Seal
M12 x 1	H17	38	120°

**FB014-3**

Thread	Seat	Length	Seal
M10 x 1	H17	37	84°

**FB015**

Thread	Seat	Length	Seal
3/8X24	H14	34	120°

**FB016**

Thread	Seat	Length	Seal
3/8X20	H15	44	120°

**FB017**

Thread	Seat	Length	Seal
M10X1	Φ16	38	120°

**FB017-2**

Thread	Seat	Length	Seal
M10X1	Φ17	35.5	120°

**FB017-3**

Thread	Seat	Length	Seal
M10X1	Φ16	41	120°

**FB017-4**

Thread	Seat	Length	Seal
M10X1	Φ19	36	120°

**FB018**

Thread	Seat	Length	Seal
M10X1	W17	40	120°

**FB019**

Thread	Seat	Length	Seal
M10X1	Φ17	37	120°

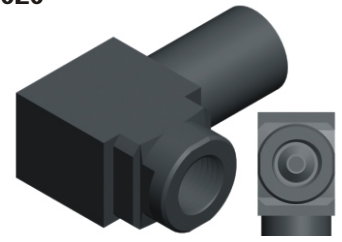
**FB020**

Thread	Seat	Length	Seal
3/8X24		46.5	84°

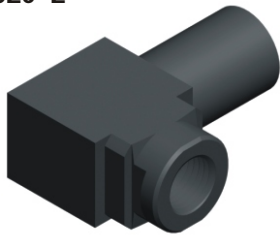
**FB020-2**

Thread	Seat	Length	Seal
M10X1		46.5	84°

**FB021**

Thread	Seat	Length	Seal
M12X1	H19	40	84°

**FB022**

Thread	Seat	Length	Seal
M10X1	H19	41	120°

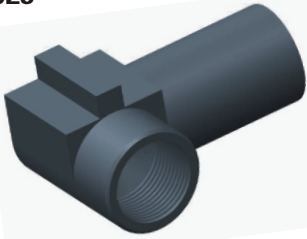
**FB023**

Thread	Seat	Length	Seal
M10X1		41	120°

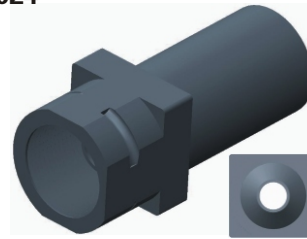
**FB024**

Thread	Seat	Length	Seal
M10X1	W16	37	84°

**FB025**

Thread	Seat	Length	Seal
7/16X24	H16	42	84°

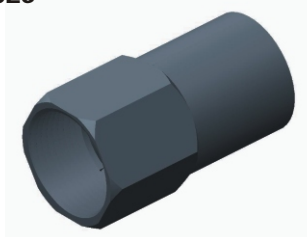
**FB026**

Thread	Seat	Length	Seal
1/2X20	H14	35.5	120°

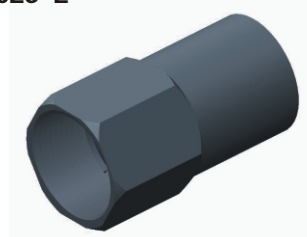
**FB026-2**

Thread	Seat	Length	Seal
1/2X20	H14	35.5	84°

**FB026-3**

Thread	Seat	Length	Seal
5/8X18	H18	35.5	84°

**FB027**

Thread	Seat	Length	Seal
M10X1	H18	35.5	84°

**FB028**

Thread	Seat	Length	Seal
M10X1	H16	41.5	120°

**FB029**

Thread	Seat	Length	Seal
3/8 x 24	H18.2	42.2	84°

**FB030**

Thread	Seat	Length	Seal
M10 x 1	Φ19	39	84°

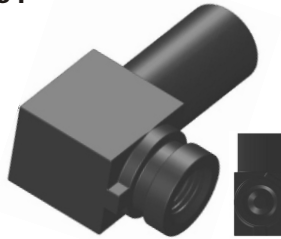
**FB031**

Thread	Seat	Length	Seal
3/8 x 24	H16	45	84°

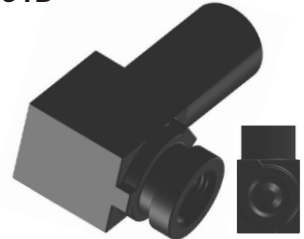
**FB031B**

Thread	Seat	Length	Seal
3/8 x 24	H16	45	84°

**FB032**

Thread	Seat	Length	Seal
M10 x 1	Φ19	35	120°

**FB033**

Thread	Seat	Length	Seal
M10 x 1	Φ18	36	84°

**FB034**

Thread	Seat	Length	Seal
3/8X24	H14		84°

**FB035**

Thread	Seat	Length	Seal
1/2X20	H17	38	84°

**FB036**

Thread	Seat	Length	Seal
M10 x 1	Φ16	36.6	120°

**FB037**

Thread	Seat	Length	Seal
M10 x 1	Φ19.3		120°

**FB038**

Thread	Seat	Length	Seal
M10 x 1	H14	37.5	120°

**FB039**

Thread	Seat	Length	Seal
M10 x 1	H18		84°

**FB040**

Thread	Seat	Length	Seal
M10 x 1	Φ17		120°

**FC001**

Thread	Seat	Length	Seal
M10X1	H26	46	84°

**FC001-2**

Thread	Seat	Length	Seal
M10X1	H26	45	84°

**FC002**

Thread	Seat	Length	Seal
M10X1	H24	57	120°

**FC002-2**

Thread	Seat	Length	Seal
M10X1	H24	57	120°

**FC002-3**

Thread	Seat	Length	Seal
3/8 x 24	H20	63	84°

**FC003**

Thread	Seat	Length	Seal
M10X1	H21	65	84°

**FC004**

Thread	Seat	Length	Seal
M14X1.5	H19	52	84°

**FC005**

Thread	Seat	Length	Seal
M12X1	H19	41	84°

**FC005-2**

Thread	Seat	Length	Seal
3/8X24	H19	41	84°

**FC006**

Thread	Seat	Length	Seal
M12X1.25	H19	42	84°

**FC007**

Thread	Seat	Length	Seal
M14X1	H19	50	84°

**FC008**

Thread	Seat	Length	Seal
M10X1	H19	40	84°

**FC009**

Thread	Seat	Length	Seal
3/8X24	H19	38	84°

**FC010**

Thread	Seat	Length	Seal
M12X1	H19	36	120°

**FC010-2**

Thread	Seat	Length	Seal
3/8x34	H19	36	84°



**FC011**

Thread	Seat	Length	Seal
M10X1	H19	38	120°

**FC012**

Thread	Seat	Length	Seal
M8X1.25	H17	45	120°

**FC013**

Thread	Seat	Length	Seal
M10X1	H17	42	84°

**FC013-2**

Thread	Seat	Length	Seal
M10 x 1	H17	42	84°

**FC013-3**

Thread	Seat	Length	Seal
3/8 x 24	H17	38	84°

**FC014**

Thread	Seat	Length	Seal
M10X1	H19	44	84°

**FC015**

Thread	Seat	Length	Seal
M10X1	H19	44	84°

**FC015-2**

Thread	Seat	Length	Seal
M10X1	H16	44	84°

**FC015-3**

Thread	Seat	Length	Seal
3/8X24	H16	44	84°

**FC016**

Thread	Seat	Length	Seal
3/8X20	H17	47	120°

**FC017**

Thread	Seat	Length	Seal
M10X1	H19	44	120°

**FC018**

Thread	Seat	Length	Seal
M10X1	H17	45	120°

**FC018-2**

Thread	Seat	Length	Seal
M10X1	H16	45	120°

**FC019**

Thread	Seat	Length	Seal
3/8X24	H17	36	84°

**FC019-2**

Thread	Seat	Length	Seal
3M10X1	H17	36	120°

**FC019-3**

Thread	Seat	Length	Seal
3/8 x 24	H17	37	84°

**FC020**

Thread	Seat	Length	Seal
3/8X24	H18	40	84°

**FC021**

Thread	Seat	Length	Seal
M10X1	H17	37	120°

**FC021-2**

Thread	Seat	Length	Seal
M10X1	H18	47	120°

**FC022**

Thread	Seat	Length	Seal
M10X1	H17	38	84°

**FC022-2**

Thread	Seat	Length	Seal
M10X1	H16	38	84°

**FC022-3**

Thread	Seat	Length	Seal
3/8 x 24	H17	39	84°

**FC023**

Thread	Seat	Length	Seal
3/8X24	H17	36.5	84°

**FC023-2**

Thread	Seat	Length	Seal
3/8X24	H17	36.5	84°

**FC024**

Thread	Seat	Length	Seal
3/8X24	H16	38	84°

**FC024-2**

Thread	Seat	Length	Seal
M10X1	H16	38	84°

**FC024-3**

Thread	Seat	Length	Seal
3/8X24	H18	38	84°

**FC024-4**

Thread	Seat	Length	Seal
M10X1.25	H15.8	38	84°

**FC025**

Thread	Seat	Length	Seal
M10X1.25	H17	36	84°

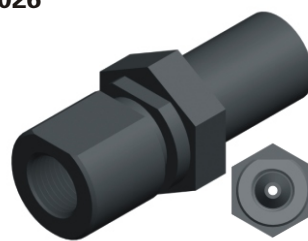
**FC026**

Thread	Seat	Length	Seal
M10X1	H19	45	84°

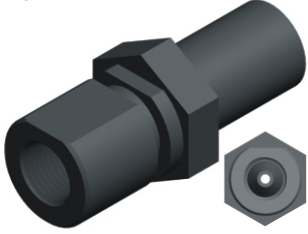
**FC026-2**

Thread	Seat	Length	Seal
M10X1	H19	45	120°

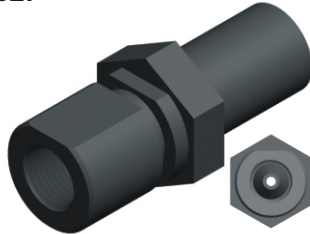
**FC027**

Thread	Seat	Length	Seal
M10X1	H17	44	120°

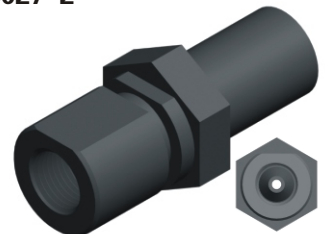
**FC027-2**

Thread	Seat	Length	Seal
M10X1	H17	44	84°

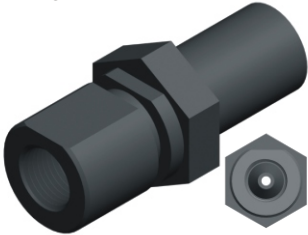
**FC027-3**

Thread	Seat	Length	Seal
M10X1	H19	44	120°

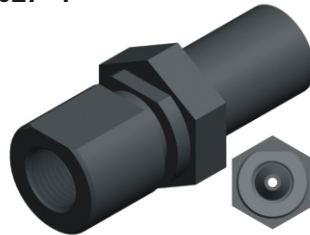
**FC027-4**

Thread	Seat	Length	Seal
M10X1	H16	44	120°

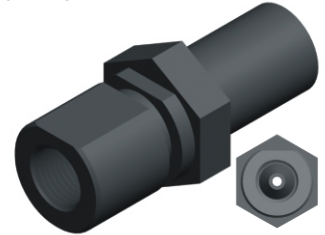
**FC027-5**

Thread	Seat	Length	Seal
M10X1	H17	46	120°

**FC028**

Thread	Seat	Length	Seal
M10X1.25	H17	44	120°

**FC029**

Thread	Seat	Length	Seal
3/8X20	H17	44	120°

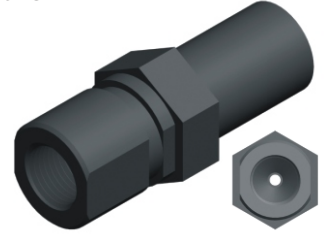
**FC029-2**

Thread	Seat	Length	Seal
3/8X20	H16	44	120°

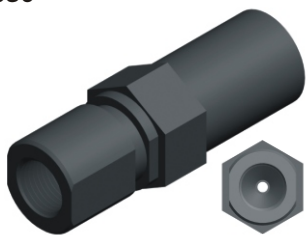
**FC030**

Thread	Seat	Length	Seal
M10X1.25	H17	50	120°

**FC031**

Thread	Seat	Length	Seal
M10X1	H17	41	120°

**FC031-2**

Thread	Seat	Length	Seal
M10X1	H16	41	120°

**FC032**

Thread	Seat	Length	Seal
3/8X24	H17	38.5	84°

**FC033**

Thread	Seat	Length	Seal
M12X1	H19	40	84°

**FC033-2**

Thread	Seat	Length	Seal
M12X1	H19	44.2	84°

**FC033-3**

Thread	Seat	Length	Seal
M12X1	H19	44	84°

**FC034**

Thread	Seat	Length	Seal
M12X1	H19	39	84°

**FC034-2**

Thread	Seat	Length	Seal
M12X1	H17	39	84°

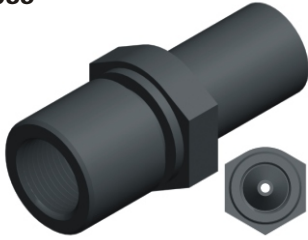
**FC035**

Thread	Seat	Length	Seal
M10X1	H19	43.5	84°

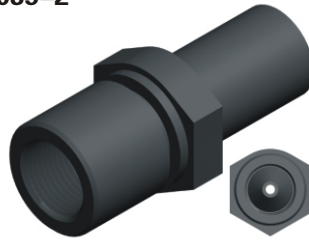
**FC035-2**

Thread	Seat	Length	Seal
M10X1	H19	43.5	84°

**FC036**

Thread	Seat	Length	Seal
3/8X24	H18	38	84°

**FC036-2**

Thread	Seat	Length	Seal
3/8X24	H18	42.8	84°

**FC036-3**

Thread	Seat	Length	Seal
7/16 x 24	H17.5	49.6	84°

**FC037**

Thread	Seat	Length	Seal
7/16X24	H19	36	84°

**FC037-2**

Thread	Seat	Length	Seal
7/16 x 24	H19	39	84°

**FC038**

Thread	Seat	Length	Seal
M10X1	H19	34	84°

**FC039**

Thread	Seat	Length	Seal
M10X1.25	H17	44	120°

**FC040**

Thread	Seat	Length	Seal
M10X1	H19	35	120°

**FC040-2**

Thread	Seat	Length	Seal
M10X1	H17	35	84°

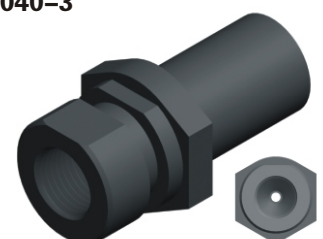
**FC040-3**

Thread	Seat	Length	Seal
M10X1	H19	35	84°

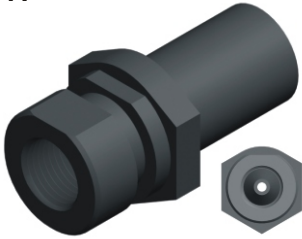
**FC041**

Thread	Seat	Length	Seal
M10X1	H19	36	84°

**FC042**

Thread	Seat	Length	Seal
3/8X24	H17	41	84°

**FC042-2**

Thread	Seat	Length	Seal
3/8X24	H16	41	84°

**FC043**

Thread	Seat	Length	Seal
3/8X24	H16	36	84°

**FC043B**

Thread	Seat	Length	Seal
3/8X24	H16	36	84°

**FC044**

Thread	Seat	Length	Seal
M10X1	H16	35	120°

**FC044B**

Thread	Seat	Length	Seal
M10X1	H16	39	120°

**FC044-2**

Thread	Seat	Length	Seal
M10X1	H16	36	120°

**FC045**

Thread	Seat	Length	Seal
M10X1	H16	42	120°

**FC046**

Thread	Seat	Length	Seal
M12X1	H16	42	120°

**FC047**

Thread	Seat	Length	Seal
3/8X24	H16	36	84°

**FC047-2**

Thread	Seat	Length	Seal
3/8 x 24	H16	37	84°

**FC048**

Thread	Seat	Length	Seal
M12X1	H19	44	84°

**FC049**

Thread	Seat	Length	Seal
M12X1.25	H19	43	120°

**FC050**

Thread	Seat	Length	Seal
M12X1	H19	43	84°

**FC050-2**

Thread	Seat	Length	Seal
M12X1	H19	44	84°

**FC051**

Thread	Seat	Length	Seal
M12X1	H19	47	120°

**FC052**

Thread	Seat	Length	Seal
M14X1	H19	50	84°

**FC053**

Thread	Seat	Length	Seal
M10X1	H19	35	120°

**FC054**

Thread	Seat	Length	Seal
M10X1	H17	36	84°

**FC054-2**

Thread	Seat	Length	Seal
M10X1	H17	36	84°

**FC054-3**

Thread	Seat	Length	Seal
M10X1	H16	36	84°

**FC054-4**

Thread	Seat	Length	Seal
M10X1	H17	36	120°

**FC055**

Thread	Seat	Length	Seal
M10X1	H17	44	84°

**FC056**

Thread	Seat	Length	Seal
3/8X24	H16	36	84°

**FC056-2**

Thread	Seat	Length	Seal
3/8X24	H16	38	84°

**FC056-3**

Thread	Seat	Length	Seal
M10 x 1	H17	48	84°

**FC057**

Thread	Seat	Length	Seal
3/8X24	H16	38	84°

**FC058**

Thread	Seat	Length	Seal
3/8X24	H16	34	84°

**FC059**

Thread	Seat	Length	Seal
3/8X24	H16	40	84°

**FC060**

Thread	Seat	Length	Seal
M10X1	H17	42	120°

**FC061**

Thread	Seat	Length	Seal
M12X1	H19	47	120°

**FC062**

Thread	Seat	Length	Seal
7/16X24	H16	37	84°

**FC063**

Thread	Seat	Length	Seal
M10X1	H17	39	120°

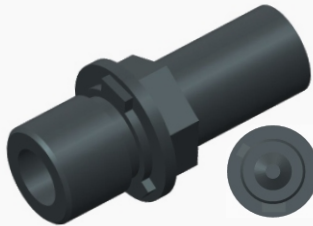
**FC064**

Thread	Seat	Length	Seal
7/16X24	H16	39	120°

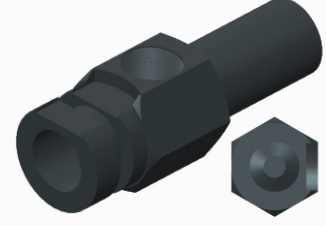
**FC065**

Thread	Seat	Length	Seal
3/8X24	H19	49	84°

**FC066**

Thread	Seat	Length	Seal
M10X1	H17	37	120°

**FC067**

Thread	Seat	Length	Seal
M10X1	H17	40	84°

**FC067-2**

Thread	Seat	Length	Seal
M10X1	H17	42	84°

**FC068**

Thread	Seat	Length	Seal
3/8X24	H16	37.5	84°

**FC069**

Thread	Seat	Length	Seal
M10X1	H19		84°

**FC070**

Thread	Seat	Length	Seal
3/8X24	H18	45	84°

**FC071**

Thread	Seat	Length	Seal
M10X1	H17	44	120°

**FC071-2**

Thread	Seat	Length	Seal
M10X1	H17	44	84°

**FC072**

Thread	Seat	Length	Seal
7/16X24	H16	45	84°

**FC073**



Thread	Seat	Length	Seal
M10X1	H17	57.5	120°

**FC074**



Thread	Seat	Length	Seal
M12X1	H17	44	84°

**FC075**



Thread	Seat	Length	Seal
M12X1	H18	46	84°

**FC076**



Thread	Seat	Length	Seal
3/8 x 24	Φ21	38.1	84°

**FC077**



Thread	Seat	Length	Seal
M10 x 1	H16	44	120°

**FC078**



Thread	Seat	Length	Seal
M10X1	H16	43	84°

**FC079**



Thread	Seat	Length	Seal
M10 x 1	Φ21	34.4	120°

**FC079B**



Thread	Seat	Length	Seal
M10 x 1	Φ21	34.4	120°

**FC080**



Thread	Seat	Length	Seal
M10 x 1	H17	38	84°

**FC081**



Thread	Seat	Length	Seal
3/8X24	H19	38	84°

**FC082**



Thread	Seat	Length	Seal
M10 x 1	H15.8		84°

**FC083**



Thread	Seat	Length	Seal
M10 x 1	H16		84°

**FC083B**



Thread	Seat	Length	Seal
M10 x 1	H16		84°

**FC084**



Thread	Seat	Length	Seal
7/16X24	Φ20.8		84°

**FC084B**



Thread	Seat	Length	Seal
7/16X24	Φ20.8		84°



**FC085**



Thread	Seat	Length	Seal
7/16X24	H16		84°

**FC086**



Thread	Seat	Length	Seal
M10X1	H17		84°

**FC087**



Thread	Seat	Length	Seal
3/8x24	H16		84°

**FD001**

Thread	Seat	Length	Seal
M10X1	Φ19	36	120°

**FD001-2**

Thread	Seat	Length	Seal
M10X1	Φ20	36	120°

**FD001-3**

Thread	Seat	Length	Seal
M10X1	Φ19	36	120°

**FD001-3B**

Thread	Seat	Length	Seal
M10X1	Φ19	35.7	120°

**FD002**

Thread	Seat	Length	Seal
M10X1	Φ22	39	84°

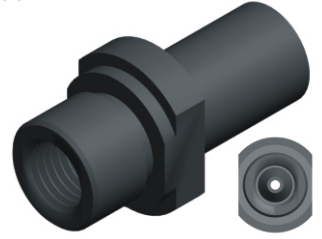
**FD002-2**

Thread	Seat	Length	Seal
M10X1	Φ21	42.5	84°

**FD002-3**

Thread	Seat	Length	Seal
M10X1	Φ22	39	84°

**FD002-4**

Thread	Seat	Length	Seal
M10X1	Φ22	38	84°

**FD002-5**

Thread	Seat	Length	Seal
M10X1	Φ22	43	84°

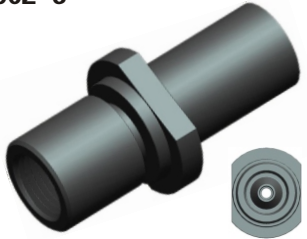
**FD002-6**

Thread	Seat	Length	Seal
M10X1	Φ22	43	84°

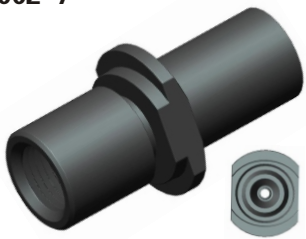
**FD002-7**

Thread	Seat	Length	Seal
M10X1	Φ22	40	84°

**FD003**

Thread	Seat	Length	Seal
M10X1	Φ20	37	84°

**FD004**

Thread	Seat	Length	Seal
M10X1	Φ20	41	84°

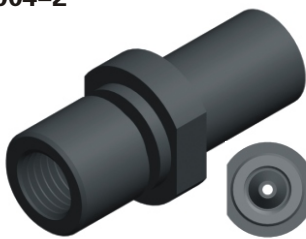
**FD004-2**

Thread	Seat	Length	Seal
M12X1	Φ23	41	84°

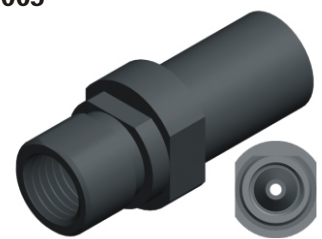
**FD005**

Thread	Seat	Length	Seal
M10X1	Φ18	42	84°

**FD005-2**

Thread	Seat	Length	Seal
M10X1	Φ18	42	84°

**FD006**

Thread	Seat	Length	Seal
M10X1	Φ18	42	120°

**FD007**

Thread	Seat	Length	Seal
M10X1	Φ23	33	84°

**FD007-2**

Thread	Seat	Length	Seal
M10X1	Φ22	33	84°

**FD007-3**

Thread	Seat	Length	Seal
M10X1	Φ24	33	84°

**FD007-4**

Thread	Seat	Length	Seal
M10X1	Φ23	33	120°

**FD008**

Thread	Seat	Length	Seal
M10X1	Φ20	35	84°

**FD008-2**

Thread	Seat	Length	Seal
M10X1	Φ19	35	84°

**FD009**

Thread	Seat	Length	Seal
M10X1	Φ20	36.5	120°

**FD009-2**

Thread	Seat	Length	Seal
M10X1	Φ20	36.5	120°

**FD009-3**

Thread	Seat	Length	Seal
M10X1	Φ20	37	120°

**FD010**

Thread	Seat	Length	Seal
M10X1	Φ21	37	84°

**FD010-2**

Thread	Seat	Length	Seal
M10X1	Φ22	37	84°

**FD010-3**

Thread	Seat	Length	Seal
M10X1	Φ22	37.5	120°

**FD010-4**

Thread	Seat	Length	Seal
M10X1	Φ22	37.8	84°

**FD011**

Thread	Seat	Length	Seal
M10X1	Φ23	36	84°

**FD012**

Thread	Seat	Length	Seal
M10X1	Φ20	36	84°

**FD012-2**

Thread	Seat	Length	Seal
M10X1	Φ22	36	84°

**FD012-3**

Thread	Seat	Length	Seal
M10X1	Φ23	36	84°

**FD012-4**

Thread	Seat	Length	Seal
M10X1	Φ23	38.2	84°

**FD013**

Thread	Seat	Length	Seal
M12X1	Φ24	41	84°

**FD014**

Thread	Seat	Length	Seal
M10X1	Φ23	36	120°

**FD014-2**

Thread	Seat	Length	Seal
M10X1	Φ20.5	36	84°

**FD015**

Thread	Seat	Length	Seal
M10X1	Φ22	37	120°

**FD016**

Thread	Seat	Length	Seal
M10X1	Φ22	43	84°

**FD017**

Thread	Seat	Length	Seal
M10X1	Φ20	35	84°

**FD018**

Thread	Seat	Length	Seal
3/8X24	Φ18	40	84°

**FD019**

Thread	Seat	Length	Seal
M10X1	Φ24	35	120°

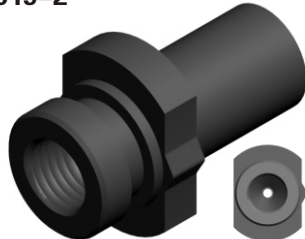
**FD019-2**

Thread	Seat	Length	Seal
M10X1	Φ23	35	120°

**FD020**

Thread	Seat	Length	Seal
M10X1	Φ23	38	84°

**FD020-2**

Thread	Seat	Length	Seal
M10X1	Φ22	38	84°

**FD020-3**

Thread	Seat	Length	Seal
M10X1	Φ24	38	84°

**FD021**

Thread	Seat	Length	Seal
M10X1	Φ23	35	84°

**FD022**

Thread	Seat	Length	Seal
M10X1	Φ23	37	84°

**FD023**

Thread	Seat	Length	Seal
M10X1	Φ19	38	120°

**FD024**

Thread	Seat	Length	Seal
M10X1	Φ20	34	84°

**FD024B**

Thread	Seat	Length	Seal
M10X1	Φ20	34	84°

**FD025**

Thread	Seat	Length	Seal
M10X1	Φ20	40	84°

**FD025-2**

Thread	Seat	Length	Seal
M12X1	Φ23	45	84°

**FD026**

Thread	Seat	Length	Seal
M10X1	Φ20	36	84°

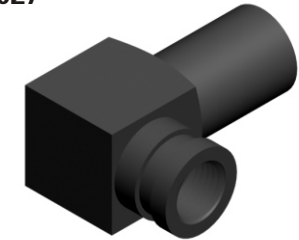
**FD027**

Thread	Seat	Length	Seal
3/8X24		34	84°

**FD028**

Thread	Seat	Length	Seal
M10X1	Φ23	38	84°

**FD028-2**

Thread	Seat	Length	Seal
M10X1	Φ23	38	120°

**FD029**

Thread	Seat	Length	Seal
M10X1	Φ19	37	120°

**FD030**

Thread	Seat	Length	Seal
M10X1	Φ23	33	84°

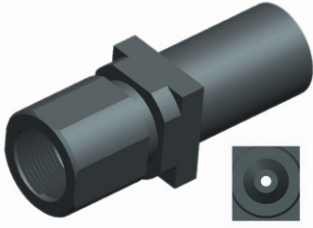
**FD031**

Thread	Seat	Length	Seal
M12X1	W16	44	84°

**FD032**

Thread	Seat	Length	Seal
M10X1	W19	40.5	120°

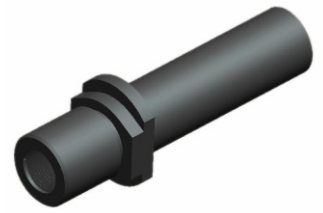
**FD033**

Thread	Seat	Length	Seal
M10X1	Φ22	65	84°

**FD034**

Thread	Seat	Length	Seal
M10X1	Φ20	44.5	120°

**FD035**

Thread	Seat	Length	Seal
3/8X24	Φ22	37.1	84°

**FD036**

Thread	Seat	Length	Seal
M10X1	Φ22	39.5	84°

**FD036B**

Thread	Seat	Length	Seal
M10X1	Φ22	39.5	84°

**FD037**

Thread	Seat	Length	Seal
M10X1	Φ20	39.2	120°

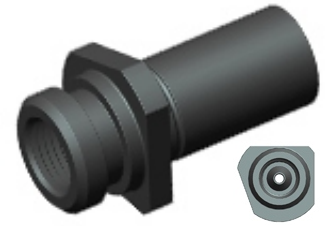
**FD038**

Thread	Seat	Length	Seal
M10X1	Φ23.3	37.5	84°

**FD039**

Thread	Seat	Length	Seal
M10X1	Φ22	36.4	84°

**FD040**

Thread	Seat	Length	Seal
M10X1	Φ22	63.4	84°

**FD041**

Thread	Seat	Length	Seal
M10X1	Φ19.2	64.5	120°

**FD042**

Thread	Seat	Length	Seal
M10X1	Φ20	33.2	84°

**FD043**

Thread	Seat	Length	Seal
M10X1	H17	34.5	84°

**FD044**

Thread	Seat	Length	Seal
M10X1	Φ22	36.4	84°

**FD045**



Thread	Seat	Length	Seal
M10X1	Φ20	38	84°

**FD046**

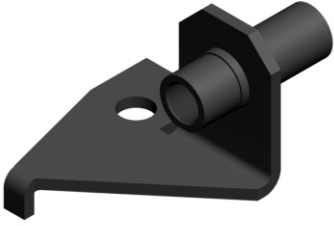

Thread	Seat	Length	Seal
M10X1	Φ23	35.4	84°

**FE001**

Thread	Seat	Length	Seal
M10X1		48	84°

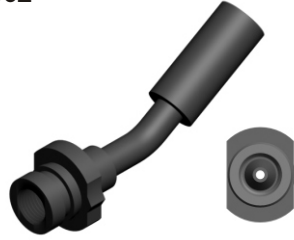
**FE002**

Thread	Seat	Angle	Seal
M10X1	Φ24	30°	84°

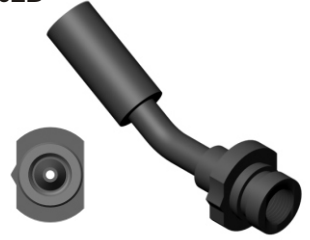
**FE002B**

Thread	Seat	Angle	Seal
M10X1	Φ24	30°	84°

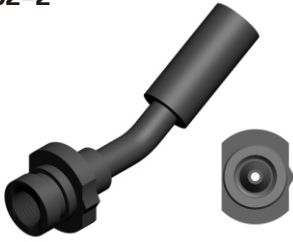
**FE002-2**

Thread	Seat	Angle	Seal
M10X1	Φ23	30°	84°

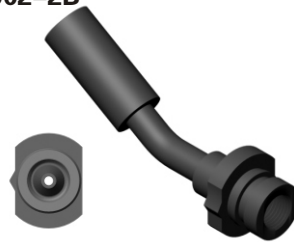
**FE002-2B**

Thread	Seat	Angle	Seal
M10X1	Φ23	30°	84°

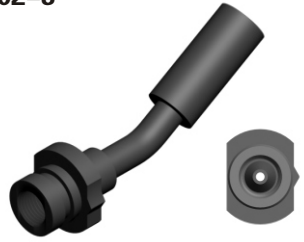
**FE002-3**

Thread	Seat	Angle	Seal
M10X1	Φ23	45°	84°

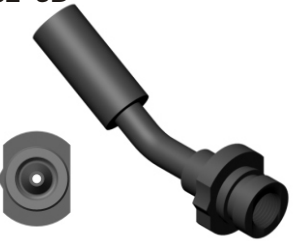
**FE002-3B**

Thread	Seat	Angle	Seal
M10X1	Φ23	45°	84°

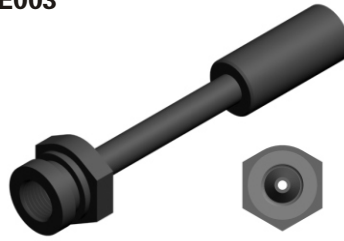
**FE003**

Thread	Seat	Length	Seal
M10X1	H19	90	84°

**FE004**

Thread	Seat	Angle	Seal
M10X1		90°	84°

**FE004B**

Thread	Seat	Angle	Seal
M10X1		90°	84°

**FE005**

Thread	Seat	Angle	Seal
M10X1	Φ22	90°	120°

**FE005B**

Thread	Seat	Angle	Seal
M10X1	Φ22	90°	120°

**FE006**

Thread	Seat	Length	Seal
3/8X24	H19	116	84°

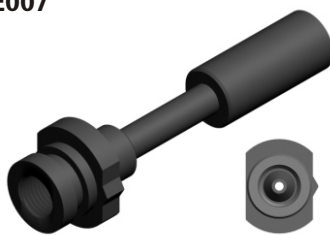
**FE007**

Thread	Seat	Length	Seal
M10X1	Φ23	79	84°

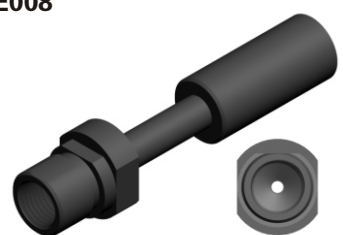
**FE008**

Thread	Seat	Length	Seal
M10X1	Φ18	68	120°



FE009

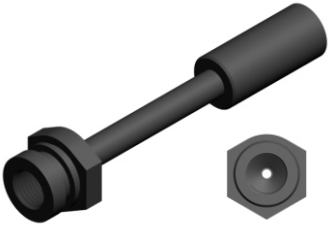

Thread	Seat	Length	Seal
M10X1	H19	82	120°

FE010



Thread	Seat	Length	Seal
M10X1		45	84°

FE011



Thread	Seat	Length	Seal
M10X1		43.5	84°

FE012

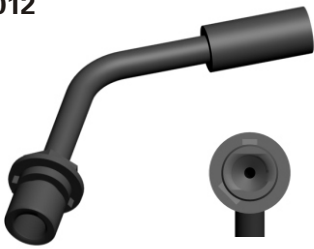

Thread	Seat	Angle	Seal
M10X1	Φ22	60°	120°

FE013



Thread	Seat	Angle	Seal
M10X1	H17	60°	84°

FE014



Thread	Seat	Length	Bend
M10X1	Φ23		45°

FE015



Thread	Seat	Length	Seal
M10X1	Φ24	43.5	84°

FE015-2



Thread	Seat	Length	Seal
M10X1	Φ24	44.4	120°

FE016

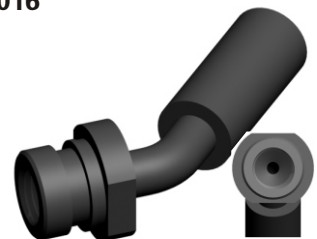

Thread	Seat	Length	Bend
M10X1	Φ20		45°

FE016-2



Thread	Seat	Angle	Seal
M10X1	Φ20	20°	120°

FE016-3

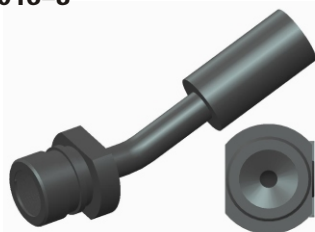

Thread	Seat	Angle	Seal
M10X1	Φ19	20°	120°

FE017

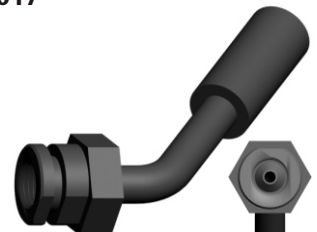

Thread	Seat		Bend
3/8x24	h19		40°

FE018



Thread	Seat	Length	Seal
3/8x24	H16		

FE019



Thread	Seat	Angle	Seal
M10X1	Φ22	90°	84°

FE020



Thread	Seat	Angle	Seal
M10X1	Φ20		120°

**FE020B**

Thread	Seat	Angle	Seal
M10X1	Φ20		120°

**FE021**

Thread	Seat	Length	Seal
M10X1	H17	54	84°

**FE022**

Thread	Seat	Length	Seal
3/8x24	H16	42	84°

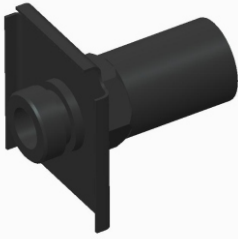
**FE023**

Thread	Seat	Length	Seal
3/8x24	H16	43	84°

**FE023-2**

Thread	Seat	Length	Seal
3/8x24	H16	41.5	84°

**FE024**

Thread	Seat	Length	Seal
3/8x24	Φ15		84°

**FE024B**

Thread	Seat	Length	Seal
3/8x24	Φ15		84°

**FE025**

Thread	Seat	Length	Seal
M10X1	Φ23	36	120°

**FE026**

Thread	Seat	Length	Seal
3/8x24	Φ20	75.9	120°

**FE027**

Thread	Seat	Length	Seal
M10X1		35.7	120°

**FE027B**

Thread	Seat	Length	Seal
M10X1		35.7	120°

**FE028**

Thread	Seat	Length	Seal
M10X1		38	120°

**FE029**

Thread	Seat	Length	Seal
M10X1	H17	52.1	84°

**FE030**

Thread	Seat	Length	Seal
M10X1		35.7	120°

**FE031**

Thread	Seat	Length	Seal
M10X1	Φ20	48	120°

**FE032**

Thread	Seat	Angle	Seal
M10X1	Φ 20		120°

**FE032B**

Thread	Seat	Angle	Seal
M10X1	Φ 20		120°

**FE033**

Thread	Seat	Angle	Seal
M10X1	Φ 20		120°

**FE033B**

Thread	Seat	Length	Seal
M10X1	Φ 20		120°

**FE034**

Thread	Seat	Length	Seal
M10X1	Φ 20		120°

**FE034B**

Thread	Seat	Length	Seal
M10X1	Φ 20		120°

**FE035**

Thread	Seat	Length	Seal
M10X1	Φ 20		120°

**FE035B**

Thread	Seat	Length	Seal
M10X1	Φ 20		120°

**FE036**

Thread	Seat	Length	Seal
M10X1	H19	58	120°

**FE037**

Thread	Seat	Length	Seal
M10X1	Φ 20		120°

**FE038**

Thread	Seat	Length	Seal
M10X1	Φ 20		120°

**FE038B**

Thread	Seat	Length	Seal
M10X1	Φ 20		120°

**FE039**

Thread	Seat	Length	Seal
M10X1	Φ 20		120°

**FE039B**

Thread	Seat	Length	Seal
M10X1	Φ 20		120°

**FE040**

Thread	Seat	Length	Seal
M10X1	Φ 20		120°

FE041



Thread	Seat	Angle	Seal
3/8X24	Φ 16.5		84°

FE042



Thread	Seat	Angle	Seal
M10X1	Φ 20		120°

FE043



Thread	Seat	Angle	Seal
M10X1	Φ 20		120°

FE043B



Thread	Seat	Angle	Seal
M10X1	Φ 20		120°

FE044



Thread	Seat	Angle	Seal
M10X1	Φ 20		120°

FE044B



Thread	Seat	Angle	Seal
M10X1	Φ 20		120°

FE045

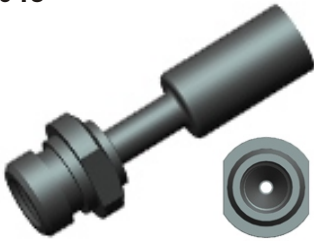

Thread	Seat	Angle	Seal
M10X1	Φ 20		120°

FE046



Thread	Seat	Angle	Seal
M10X1	Φ 16		84°

FE047

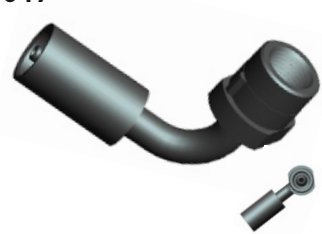

Thread	Seat	Angle	Seal
M10X1	Φ 18		84°

FE047B



Thread	Seat	Angle	Seal
M10X1	Φ 18		84°

**KFAA01**



Thread | Hole | Length | Bend

**KFAA02**



Thread | Hole | Length | Bend

**KFAA03**



Thread | Hole | Length | Bend

**KFAA04-1**

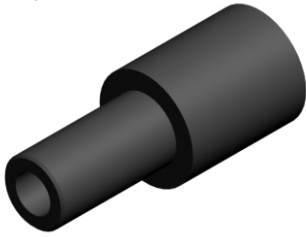

Thread | Hole | Length | Bend

**KFAA04-2**

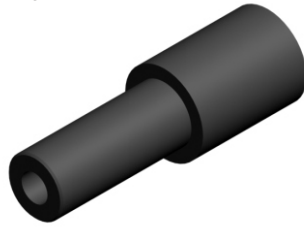

Thread | Hole | Length | Bend

**KFAA04-3**

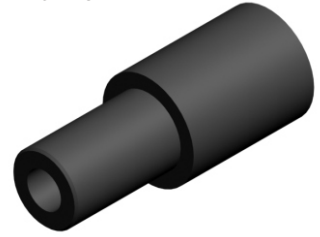

Thread | Hole | Length | Bend

**KFAA05**



Thread | Hole | Length | Bend

**KFAA06**



Thread | Hole | Length | Bend

**KFAA07**



Thread | Hole | Length | Bend

**KFAA08**



Thread | Hole | Length | Bend

**KFAA09**



Thread | Hole | Length | Bend

**KFAA10**



Thread | Hole | Length | Bend

**KFAA11**



Thread | Hole | Length | Bend

**KFAA12**



Thread | Hole | Length | Bend

**KFAA13-1**

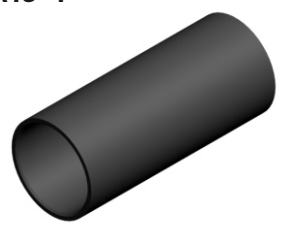

Thread | Hole | Length | Bend

**KFAA13-2**



Thread | Hole | Length | Bend

**KFAA14**



Thread | Hole | Length | Bend

**KFAA15-1**

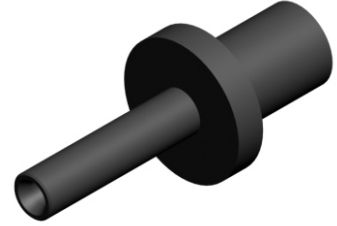

Thread | Hole | Length | Bend

**KFAA15-2**



Thread | Hole | Length | Bend

**KFAA15-3**



Thread | Hole | Length | Bend

**KFAA16-1**



Thread | Hole | Length | Bend

**KFAA16-2**



Thread | Hole | Length | Bend

**KFAA16-3**



Thread | Hole | Length | Bend

**KFAA16-4**



Thread | Hole | Length | Bend

**KFAA16-5**



Thread | Hole | Length | Bend

**KFAA17**

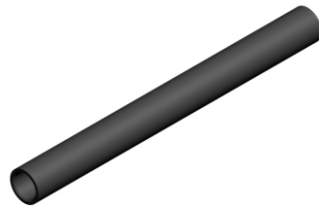

Thread | Hole | Length | Bend

**KFAA18-1**

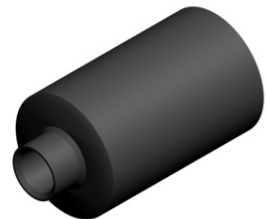

Thread | Hole | Length | Bend

**KFAA18-2**



Thread | Hole | Length | Bend

**KFAA19**



Thread | Hole | Length | Bend

**KFAA20**

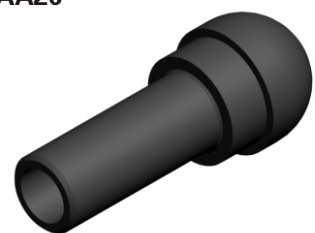

Thread | Hole | Length | Bend

**KFAA21**



Thread | Hole | Length | Bend

**KFAA21-2**



Thread | Hole | Length | Bend

**KFAA22**



Thread | Hole | Length | Bend

**KFAA23**

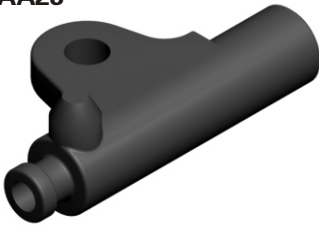

Thread | Hole | Length | Bend

**KFAA24**



Thread | Hole | Length | Bend

**KFAA25**

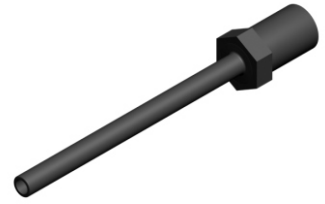

Thread | Hole | Length | Bend

**KFAA26**

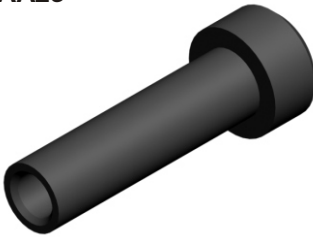

Thread | Hole | Length | Bend

**KFAA27**

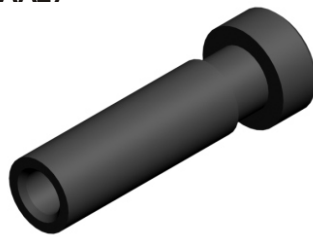

Thread | Hole | Length | Bend

**KFAA28**



Thread | Hole | Length | Bend

**KFAA29**

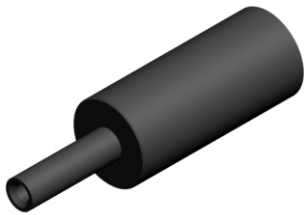

Thread | Hole | Length | Bend

**KFAA30-1**



Thread | Hole | Length | Bend

**KFAA30-2**



Thread | Hole | Length | Bend

**KFAA31**



Thread | Hole | Length | Bend

**KFAA32**

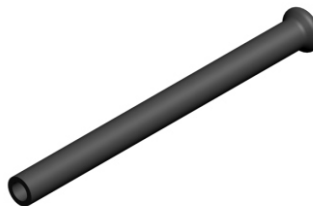

Thread | Hole | Length | Bend

**KFAA33**



Thread | Hole | Length | Bend

**KFAA34**



Thread | Hole | Length | Bend

**KFAA35**



Thread | Hole | Length | Bend

**KFAA36-1**

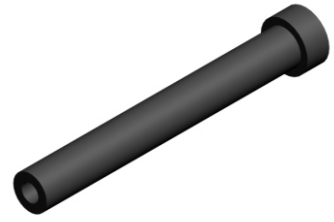

Thread | Hole | Length | Bend

**KFAA36-2**



Thread | Hole | Length | Bend

**KFAA37-1**



Thread | Hole | Length | Bend

**KFAA37-2**



Thread | Hole | Length | Bend

**KFAA38**



Thread | Hole | Length | Bend

**KFAA39**



Thread | Hole | Length | Bend

**KFAA40**



Thread | Hole | Length | Bend

**KFAA41**

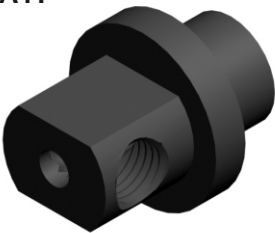

Thread | Hole | Length | Bend

**KFAA42**



Thread | Hole | Length | Bend

**KFAA43-1**



Thread | Hole | Length | Bend

**KFAA43-2**



Thread | Hole | Length | Bend

**KFAA44**



Thread | Hole | Length | Bend

**KFAA45**



Thread | Hole | Length | Bend



**KFAA46**



Thread | Hole | Length | Bend

**KFAA47-1**



Thread | Hole | Length | Bend

**KFAA47-2**



Thread | Hole | Length | Bend

**KFAA48**



Thread | Hole | Length | Bend

**KFAA49**



Thread | Hole | Length | Bend

**KFAA50-1**

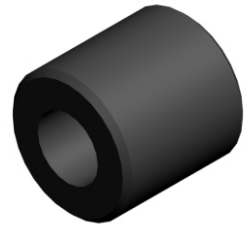

Thread | Hole | Length | Bend

**KFAA50-2**



Thread | Hole | Length | Bend

**KFAA50-3**



Thread | Hole | Length | Bend

**KFAA50-4**



Thread | Hole | Length | Bend

**KFAA50-5**

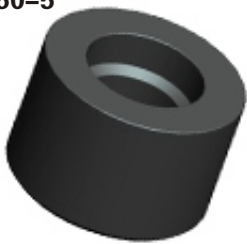

Thread | Hole | Length | Bend

**KFAA50-6**

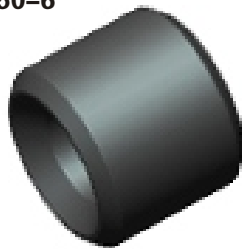

Thread | Hole | Length | Bend

**KFAA50-7**



Thread | Hole | Length | Bend

**KFAA51**

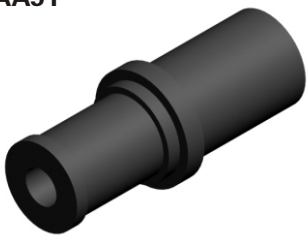

Thread | Hole | Length | Bend

**KFAA52-1**



Thread | Hole | Length | Bend

**KFAA52-2**



Thread | Hole | Length | Bend

**KFAA53**

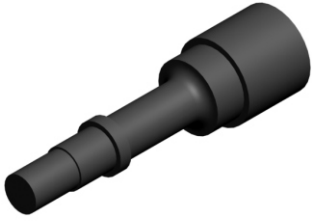

Thread | Hole | Length | Bend

**KFAA54**

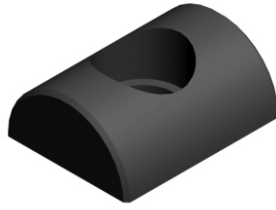

Thread | Hole | Length | Bend

**KFAA55-1**



Thread | Hole | Length | Bend

**KFAA55-2**



Thread | Hole | Length | Bend

**KFAA55-3**

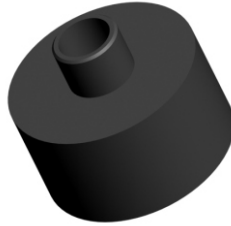

Thread | Hole | Length | Bend

**KFAA55-4**

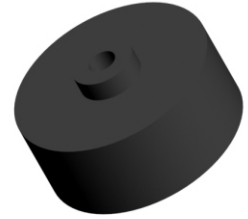

Thread | Hole | Length | Bend

**KFAA56**



Thread | Hole | Length | Bend

**KFAA57**



Thread | Hole | Length | Bend

**KFAA58**



Thread | Hole | Length | Bend

**KFAA59-1**

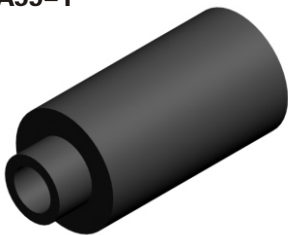

Thread | Hole | Length | Bend

**KFAA59-2**



Thread | Hole | Length | Bend

**KFAA59-3**



Thread | Hole | Length | Bend

**KFAA59-4**



Thread | Hole | Length | Bend

**KFAA59-5**



Thread | Hole | Length | Bend

**KFAA59-6**



Thread | Hole | Length | Bend

**KFAA59-7**



Thread | Hole | Length | Bend

**KFAA60**



Thread | Hole | Length | Bend

**KFAA61**



Thread | Hole | Length | Bend

**KFAA62**

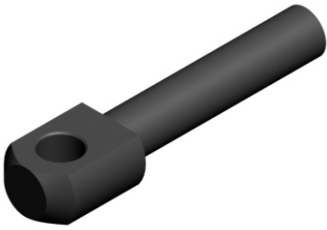

Thread | Hole | Length | Bend

**KFAA63**



Thread

**KFAA64**



Thread | Hole | Length | Bend

**KFAA65**

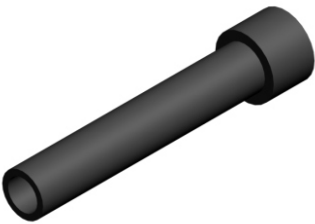

Thread | Hole | Length | Bend

**KFAA66**

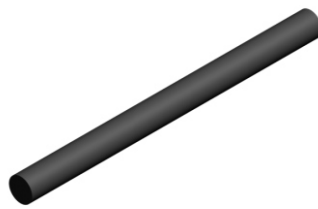

Thread | Hole | Length | Bend

**KFAA67**



Thread | Hole | Length | Bend

**KFAA68**



Thread | Hole | Length | Bend

**KFAA69**



Thread | Hole | Length | Bend

**KFAA70**

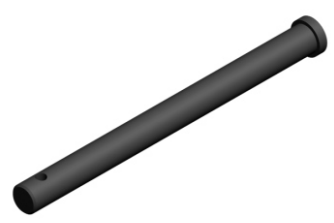

Thread | Hole | Length | Bend

**KFAA71-1**

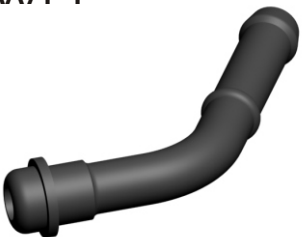

Thread | Hole | Length | Bend

**KFAA71-2**

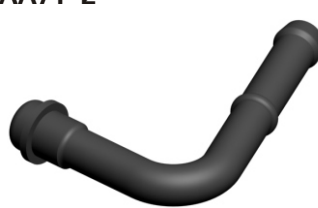

Thread | Hole | Length | Bend

**KFAA71-3**

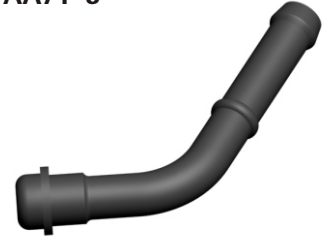

Thread | Hole | Length | Bend

**KFAA72-1**



Thread | Hole | Length | Bend

**KFAA72-2**



Thread | Hole | Length | Bend

**KFAA72-3**



Thread | Hole | Length | Bend

**KFAA72-4**



Thread | Hole | Length | Bend

**KFAA73**



Thread | Hole | Length | Bend

**KFAA74**



Thread | Hole | Length | Bend

**KFAA75**



Thread | Hole | Length | Bend

**KFAA76**



Thread | Hole | Length | Bend

**KFAA77**

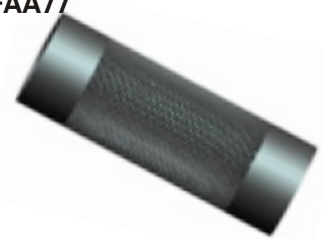

Thread | Hole | Length | Bend

**KFAA78**



Thread | Hole | Length | Bend

**KFAA79**



Thread | Hole | Length | Bend

**KFAA80**



Thread | Hole | Length | Bend

**KFAA81**

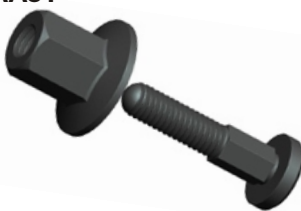

Thread | Hole | Length | Bend

**KFAA82**



Thread | Hole | Length | Bend

**KFAA83**



Thread | Hole | Length | Bend



**KFAA97**



Thread | Hole | Length | Bend

**KFAA98**



Thread | Hole | Length | Bend

**KFAA99**



Thread | Hole | Length | Bend

**KFAA100**



Thread | Hole | Length | Bend

**KFAA101**



Thread | Hole | Length | Bend

**KFAA102**



Thread | Hole | Length | Bend

**KFAA103**



Thread | Hole | Length | Bend

**KFAA104**



Thread | Hole | Length | Bend

**KFAA105**



Thread | Hole | Length | Bend

**KFAA106**



Thread | Hole | Length | Bend

**KFAA107**



Thread | Hole | Length | Bend

**KFAA108**



Thread | Hole | Length | Bend

**KFAA109**

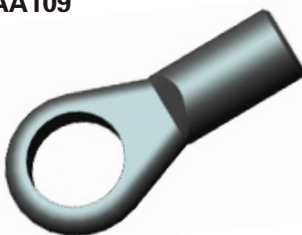

Thread | Hole | Length | Bend

**KFAA110**



Thread | Hole | Length | Bend

**KFAA111**



Thread | Hole | Length | Bend

**KFAA112**



Thread | Hole | Length | Bend

**KFAA113**



Thread | Hole | Length | Bend

**KFAA114**



Thread | Hole | Length | Bend

**KFAA115**



Thread | Hole | Length | Bend

**KFAA116**



Thread | Hole | Length | Bend

**KFAA117**



Thread | Hole | Length | Bend

**KFAA118**



Thread | Hole | Length | Bend

**KFAA119**



Thread | Hole | Length | Bend

**KFAA119-2**



Thread | Hole | Length | Bend

**KFAA119-3**



Thread | Hole | Length | Bend

**KFAA120**



Thread | Hole | Length | Bend

**KFAA121**



Thread | Hole | Length | Bend

**KFAA122**

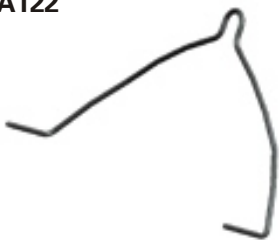

Thread | Hole | Length | Bend

**KFAA123**



Thread | Hole | Length | Bend

**KFAA124**

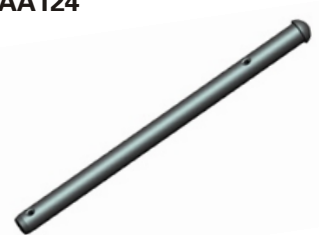

Thread | Hole | Length | Bend

**KFAA125**



Thread | Hole | Length | Bend

**KFAA126**



Thread | Hole | Length | Bend

**KFAA127**



Thread | Hole | Length | Bend

**KFAA128**



Thread | Hole | Length | Bend

**KFAA129**

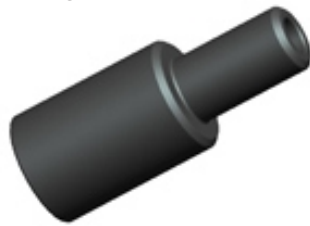

Thread | Hole | Length | Bend

**KFAA130**



Thread | Hole | Length | Bend

**KFAA131**



Thread | Hole | Length | Bend

**KFAA132**



Thread | Hole | Length | Bend

**KFAA132B**



Thread | Hole | Length | Bend

**KFAA133**



Thread | Hole | Length | Bend

**KFAA133B**



Thread | Hole | Length | Bend

**KFAA134**



Thread | Hole | Length | Bend

**KFAA135**



Thread | Hole | Length | Bend

**KFAA136**



Thread | Hole | Length | Bend

**KFAA137**



Thread | Hole | Length | Bend



**KFAA138**



Thread | Hole | Length | Bend

**KFAA138-2**



Thread | Hole | Length | Bend

**KFAA138-3**



Thread | Hole | Length | Bend

**KFAA138-4**



Thread | Hole | Length | Bend

**KFAA138-5**



Thread | Hole | Length | Bend

**KFAA138-6**



Thread | Hole | Length | Bend

**KFAA138-7**



Thread | Hole | Length | Bend

**KFAA138-8**



Thread | Hole | Length | Bend

**KFAA139**



Thread | Hole | Length | Bend

**KFAA140**



Thread | Hole | Length | Bend

**KFAA140-2**



Thread | Hole | Length | Bend

**KFAA141**

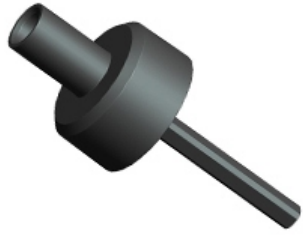

Thread | Hole | Length | Bend

**KFAA142**

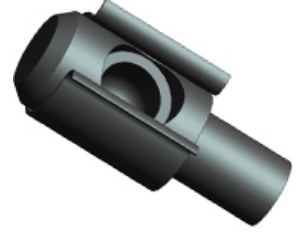

Thread | Hole | Length | Bend

**KFAA142-2**



Thread | Hole | Length | Bend

**KFAA142-3**



Thread | Hole | Length | Bend

**KFAA143**



Thread | Hole | Length | Bend

**KFAA144**



Thread | Hole | Length | Bend

**KFAA145**



Thread | Hole | Length | Bend

**KFAA146**



Thread | Hole | Length | Bend

**KFAA146-2**



Thread | Hole | Length | Bend

**KFAA146-3**



Thread | Hole | Length | Bend

**KFAA146-4**



Thread | Hole | Length | Bend

**KFAA146-5**



Thread | Hole | Length | Bend

**KFAA146-6**



Thread | Hole | Length | Bend

**KFAA147**



Thread | Hole | Length | Bend

**KFAA147-2**



Thread | Hole | Length | Bend

**KFAA148**



Thread | Hole | Length | Bend

**KFAA149**



Thread | Hole | Length | Bend

**KFAA150**

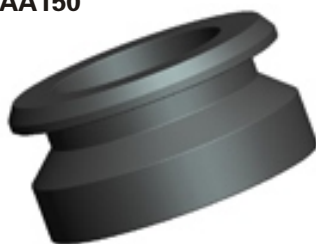

Thread | Hole | Length | Bend

**KFAA151**



Thread | Hole | Length | Bend

KFAA152



Thread | Hole | Length | Bend

KFAA153



Thread | Hole | Length | Bend

KFAA154



Thread | Hole | Length | Bend

KFAA155



Thread | Hole | Length | Bend

KFAA156



Thread | Hole | Length | Bend

KFAA157



Thread | Hole | Length | Bend

KFAA157-2



Thread | Hole | Length | Bend

KFAA158



Thread | Hole | Length | Bend

KFAA159



Thread | Hole | Length | Bend

KFAA160



Thread | Hole | Length | Bend

KFAA161



Thread | Hole | Length | Bend

KFAA162



Thread | Hole | Length | Bend

KFAA163



Thread | Hole | Length | Bend

KFAA164



Thread | Hole | Length | Bend

KFAA165



Thread | Hole | Length | Bend

KFAA166



Thread | Hole | Length | Bend

KFAA167



Thread | Hole | Length | Bend

KFAA168



Thread | Hole | Length | Bend

KFAA169



Thread | Hole | Length | Bend

KFAA170



Thread | Hole | Length | Bend

KFAA171



Thread | Hole | Length | Bend

KFAA172



Thread | Hole | Length | Bend

KFAA173



Thread | Hole | Length | Bend

KFAA174



Thread | Hole | Length | Bend

KFAA175

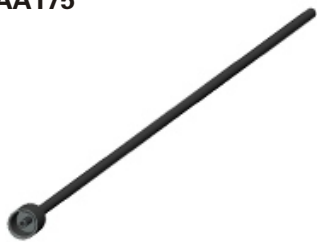

Thread | Hole | Length | Bend

KFAA176



Thread | Hole | Length | Bend

KFAA177

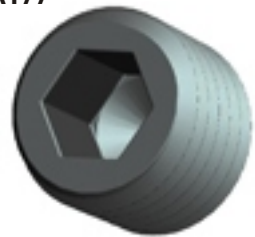

Thread | Hole | Length | Bend

KFAA178



Thread | Hole | Length | Bend

KFAA179

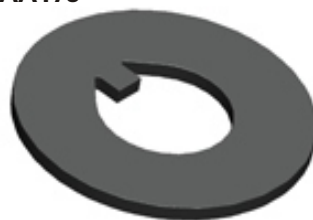

Thread | Hole | Length | Bend

KFAA180



Thread | Hole | Length | Bend

KFAA181



Thread | Hole | Length | Bend

KFAA182



Thread | Hole | Length | Bend

KFAA183



Thread | Hole | Length | Bend

KFAA184



Thread | Hole | Length | Bend

KFAA185



Thread | Hole | Length | Bend

KFAA186



Thread | Hole | Length | Bend

KFAA187



Thread | Hole | Length | Bend

KFAA188

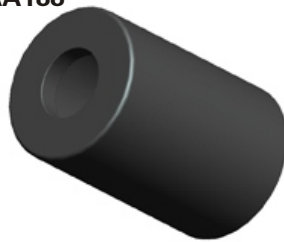

Thread | Hole | Length | Bend

KFAA189

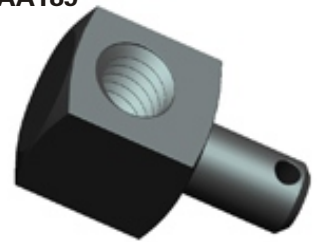

Thread | Hole | Length | Bend

KFAA190



Thread | Hole | Length | Bend

KFAA191



Thread | Hole | Length | Bend

KFAA192



Thread | Hole | Length | Bend

KFAA193



Thread | Hole | Length | Bend

KFAA194



Thread | Hole | Length | Bend

KFAA195



Thread | Hole | Length | Bend

KFAA196



Thread | Hole | Length | Bend

KFAA197



Thread | Hole | Length | Bend

KFAA198



Thread | Hole | Length | Bend

KFAA199



Thread | Hole | Length | Bend

KFAA200



Thread | Hole | Length | Bend

KFAA201



Thread | Hole | Length | Bend

KFAA202

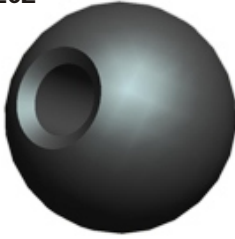

Thread | Hole | Length | Bend

KFAA203



Thread | Hole | Length | Bend

KFAA204

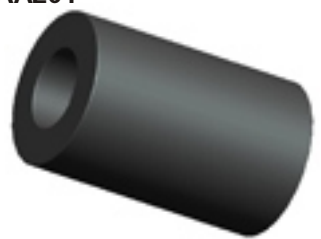

Thread | Hole | Length | Bend

KFAA205



Thread | Hole | Length | Bend

KFAA206



Thread | Hole | Length | Bend

KFAA207



KST BRAKE HOSE

Thread | Hole | Length | Bend

KFAA208



Thread | Hole | Length | Bend

KFAA209

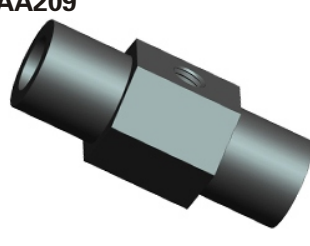

Thread | Hole | Length | Bend

KFAA210

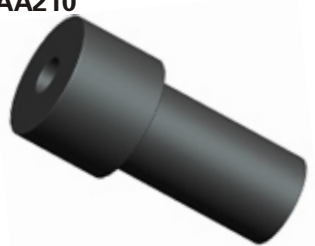

Thread | Hole | Length | Bend

KFAA211

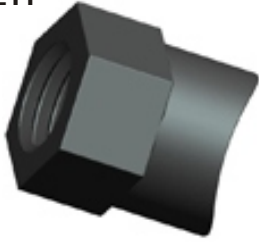

Thread | Hole | Length | Bend

KFAA212



Thread | Hole | Length | Bend

KFAA213



Thread | Hole | Length | Bend

KFAA214



Thread | Hole | Length | Bend

KFAA215



Thread | Hole | Length | Bend

KFAA216



Thread | Hole | Length | Bend

KFAA217



Thread | Hole | Length | Bend

KFAA218



Thread | Hole | Length | Bend

KFAA219



Thread | Hole | Length | Bend

KFAA220



Thread | Hole | Length | Bend

KFAA221



Thread | Hole | Length | Bend

KFAA222



Thread | Hole | Length | Bend

KFAA223



Thread | Hole | Length | Bend

KFAA224



Thread | Hole | Length | Bend

KFAA225



Thread | Hole | Length | Bend

KFAA226



Thread | Hole | Length | Bend

KFAA227



Thread | Hole | Length | Bend

KFAA228



Thread | Hole | Length | Bend

KFAA229



Thread | Hole | Length | Bend

KFAA230



Thread | Hole | Length | Bend

KFAA231



Thread | Hole | Length | Bend

KFAA232



Thread | Hole | Length | Bend

KFAA233



Thread | Hole | Length | Bend

KFAA234



Thread | Hole | Length | Bend

KFAA235



Thread | Hole | Length | Bend

KFAA236



Thread | Hole | Length | Bend

KFAA237



Thread | Hole | Length | Bend

KFAA238



Thread | Hole | Length | Bend

KFAA239



Thread | Hole | Length | Bend

KFAA240



Thread | Hole | Length | Bend



KFAA241



Thread | Hole | Length | Bend

KFAA242



Thread | Hole | Length | Bend

KFAA243



Thread | Hole | Length | Bend

KFAA244



Thread | Hole | Length | Bend

KFAA245



Thread | Hole | Length | Bend

KFAA246



Thread | Hole | Length | Bend

KFAA247

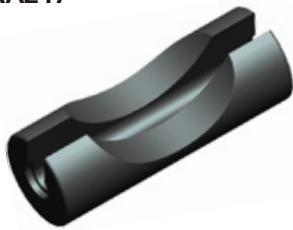

Thread | Hole | Length | Bend

**KFAB01**



Thread | Hole | Length | Bend

**KFAB02**



Thread | Hole | Length | Bend

**KFAB03**



Thread | Hole | Length | Bend

**KFAB04**



Thread | Hole | Length | Bend

**KFAB05**



Thread | Hole | Length | Bend

**KFAB06**



Thread | Hole | Length | Bend

**KFAB07**



Thread | Hole | Length | Bend

**KFAB08**



Thread | Hole | Length | Bend

**KFAB09**



Thread | Hole | Length | Bend

**KFAB09-2**

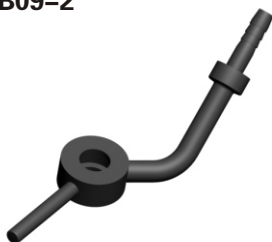

Thread | Hole | Length | Bend

**KFAB10**



Thread | Hole | Length | Bend

**KFAB11**



Thread | Hole | Length | Bend

**KFAB12-1**



Thread | Hole | Length | Bend

**KFAB12-2**



Thread | Hole | Length | Bend

**KFAB12-3**



Thread | Hole | Length | Bend

**KFAB12-4**



Thread | Hole | Length | Bend

**KFAB13**



Thread | Hole | Length | Bend

**KFAB14**



Thread | Hole | Length | Bend

**KFAB15**

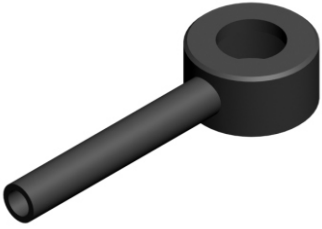

Thread | Hole | Length | Bend

**KFAB16**



Thread | Hole | Length | Bend

**KFAB17-1**



Thread | Hole | Length | Bend

**KFAB17-2**

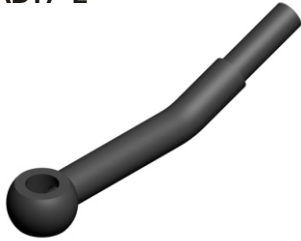

Thread | Hole | Length | Bend

**KFAB17-3**



Thread | Hole | Length | Bend

**KFAB18-1**



Thread | Hole | Length | Bend

**KFAB18-2**



Thread | Hole | Length | Bend

**KFAB19**



Thread | Hole | Length | Bend

**KFAB20-1**

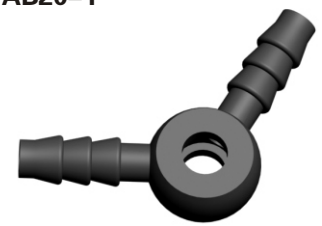

Thread | Hole | Length | Bend

**KFAB20-2**



Thread | Hole | Length | Bend

**KFAB21**



Thread | Hole | Length | Bend

**KFAB22**



Thread | Hole | Length | Bend

**KFAB23**



Thread | Hole | Length | Bend

**KFAB24**

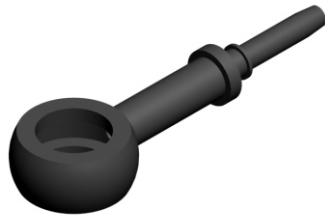

Thread | Hole | Length | Bend

**KFAB25-1**

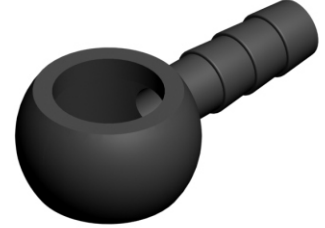

Thread | Hole | Length | Bend

**KFAB25-2**



Thread | Hole | Length | Bend

**KFAB25-3**

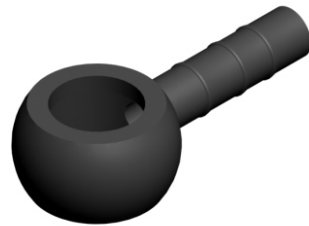

Thread | Hole | Length | Bend

**KFAB26**



Thread | Hole | Length | Bend

**KFAB27-1**



Thread | Hole | Length | Bend

**KFAB27-2**



Thread | Hole | Length | Bend

**KFAB27-3**



Thread | Hole | Length | Bend

**KFAB28**



Thread | Hole | Length | Bend

**KFAB29**



Thread | Hole | Length | Bend

**KFAB30**



Thread | Hole | Length | Bend

**KFAB31**

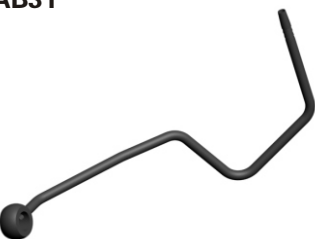

Thread | Hole | Length | Bend

**KFAB32**



Thread | Hole | Length | Bend

**KFAB32-2**



Thread | Hole | Length | Bend

**KFAB33**



Thread | Hole | Length | Bend

**KFAB34-1**



Thread | Hole | Length | Bend

**KFAB34-2**



Thread | Hole | Length | Bend

**KFAB34-3**



Thread | Hole | Length | Bend

**KFAB35**



Thread | Hole | Length | Bend

**KFAB36**



Thread | Hole | Length | Bend

**KFAB37**



Thread | Hole | Length | Bend

**KFAB38**



Thread | Hole | Length | Bend

**KFAB39**



Thread | Hole | Length | Bend

**KFAB40**



Thread | Hole | Length | Bend  
7/16X20 | 51

**KFAB41**

Thread | Hole | Length | Bend

**KFAB42**

Thread | Hole | Length | Bend

**KFAB43**

Thread | Hole | Length | Bend

**KFAB44**



Thread | Hole | Length | Bend

**KFAB45**



Thread | Hole | Length | Bend

**KFAB46**



Thread | Hole | Length | Bend

**KFAB47**



Thread | Hole | Length | Bend

**KFAC01**



Thread | Hole | Length | Bend

**KFAC02**



Thread | Hole | Length | Bend

**KFAC03**



Thread | Hole | Length | Bend

**KFAC04**



Thread | Hole | Length | Bend

**KFAC05**



Thread | Hole | Length | Bend

**KFAC06**



Thread | Hole | Length | Bend

**KFAC07**

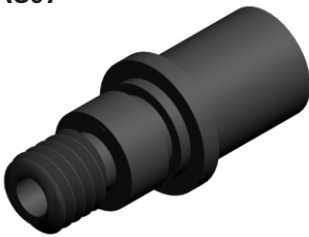

Thread | Hole | Length | Bend

**KFAC08**



Thread | Hole | Length | Bend

**KFAC09**



Thread | Hole | Length | Bend

**KFAC09-2**



Thread | Hole | Length | Bend

**KFAC09-3**



Thread | Hole | Length | Bend

**KFAC09-4**



Thread | Hole | Length | Bend

**KFAC10**



Thread | Hole | Length | Bend

**KFAC11-1**



Thread | Hole | Length | Bend

**KFAC11-2**



Thread | Hole | Length | Bend

**KFAC11-3**



Thread | Hole | Length | Bend

**KFAC11-4**



Thread | Hole | Length | Bend

**KFAC12-1**



Thread | Hole | Length | Bend

**KFAC12-2**



Thread | Hole | Length | Bend

**KFAC13**



Thread | Hole | Length | Bend

**KFAC14-1**



Thread | Hole | Length | Bend

**KFAC14-2**



Thread | Hole | Length | Bend

**KFAC14-3**



Thread | Hole | Length | Bend

**KFAC14-4**



Thread | Hole | Length | Bend

**KFAC15**



Thread | Hole | Length | Bend

**KFAC16**

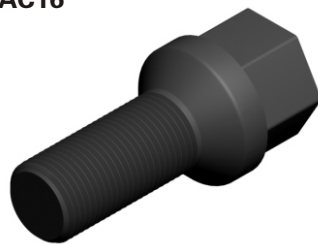

Thread | Hole | Length | Bend

**KFAC17**



Thread | Hole | Length | Bend

**KFAC18**



Thread | Hole | Length | Bend

**KFAC19-1**

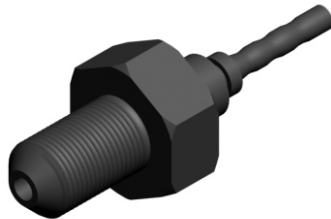

Thread | Hole | Length | Bend

**KFAC19-2**



Thread | Hole | Length | Bend



**KFAC20**



Thread | Hole | Length | Bend

**KFAC21**



Thread | Hole | Length | Bend

**KFAC21-2**



Thread | Hole | Length | Bend

**KFAC22**



Thread | Hole | Length | Bend

**KFAC22-2**



Thread | Hole | Length | Bend

**KFAC22-3**



Thread | Hole | Length | Bend

**KFAC22-4**



Thread | Hole | Length | Bend

**KFAC22-5**



Thread | Hole | Length | Bend

**KFAC23**



Thread | Hole | Length | Bend

**KFAC24**



Thread | Hole | Length | Bend

**KFAC25**



Thread | Hole | Length | Bend

**KFAC26**



Thread | Hole | Length | Bend

**KFAC27**

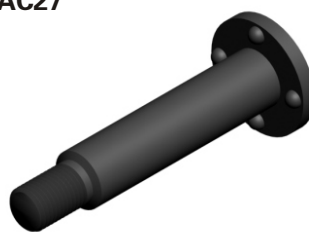

Thread | Hole | Length | Bend

**KFAC28**



Thread | Hole | Length | Bend

**KFAC29**

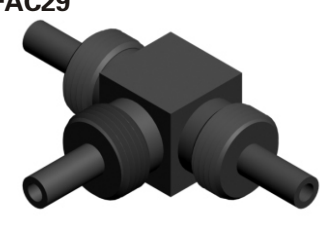

Thread | Hole | Length | Bend

**KFAC30**



Thread | Hole | Length | Bend

**KFAC31**

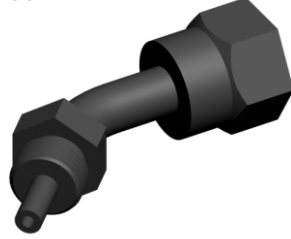

Thread | Hole | Length | Bend

**KFAC32**

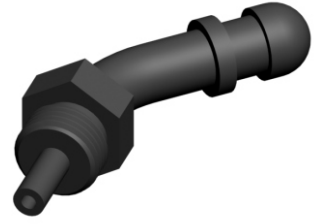

Thread | Hole | Length | Bend

**KFAC33**

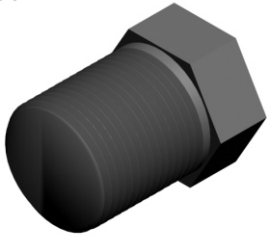

Thread | Hole | Length | Bend

**KFAC34**

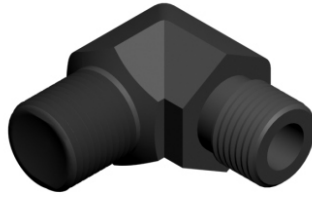

Thread | Hole | Length | Bend

**KFAC35**

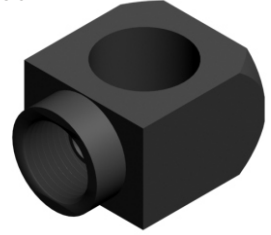

Thread | Hole | Length | Bend

**KFAC36**



Thread | Hole | Length | Bend

**KFAC37**



Thread | Hole | Length | Bend

**KFAC38**



Thread | Hole | Length | Bend

**KFAC38-2**



Thread | Hole | Length | Bend

**KFAC38-3**



Thread | Hole | Length | Bend

**KFAC38-4**



Thread | Hole | Length | Bend

**KFAC38-5**



Thread | Hole | Length | Bend

**KFAC38-6**



Thread | Hole | Length | Bend

**KFAC38-7**



Thread | Hole | Length | Bend

**KFAC38-8**



Thread | Hole | Length | Bend

**KFAC38-9**



Thread | Hole | Length | Bend

**KFAC39**



Thread | Hole | Length | Bend

**KFAC40**



Thread | Hole | Length | Bend

**KFAC41**



Thread | Hole | Length | Bend

**KFAC41-2**

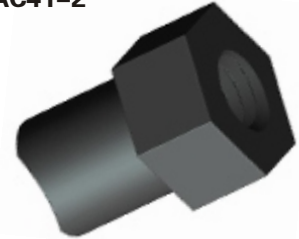

Thread | Hole | Length | Bend

**KFAC42**



Thread | Hole | Length | Bend

**KFAC43**



Thread | Hole | Length | Bend

**KFAC44**



Thread | Hole | Length | Bend

**KFAC45**

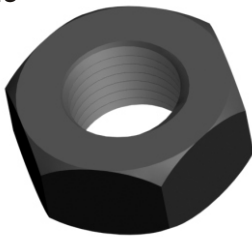

Thread | Hole | Length | Bend

**KFAC45-2**

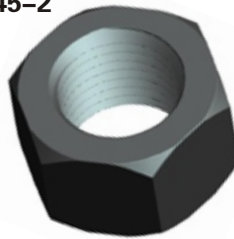

Thread | Hole | Length | Bend

**KFAC45-3**

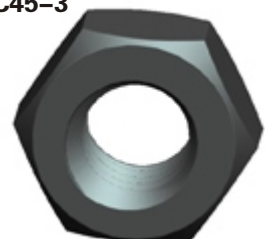

Thread | Hole | Length | Bend

**KFAC45-4**



Thread | Hole | Length | Bend

**KFAC45-5**

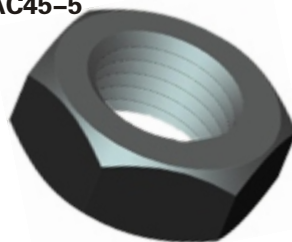

Thread | Hole | Length | Bend

**KFAC46**

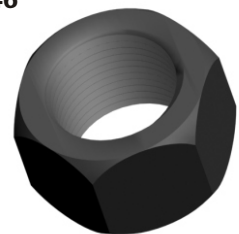

Thread | Hole | Length | Bend

**KFAC47**

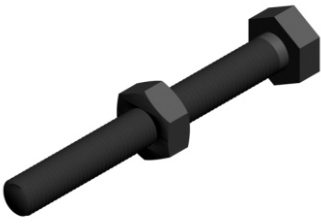

Thread | Hole | Length | Bend

**KFAC48**



Thread | Hole | Length | Bend

**KFAC48-2**



Thread | Hole | Length | Bend

**KFAC49**



Thread | Hole | Length | Bend

**KFAC49-2**



Thread | Hole | Length | Bend

**KFAC50**



Thread | Hole | Length | Bend

**KFAC51**



Thread | Hole | Length | Bend

**KFAC51-2**



Thread | Hole | Length | Bend

**KFAD01**

Thread	Seat	Length
7/16X24--7/16X24	H13	19

**KFAD02**

Thread	Seat	Length
M10X1--1/8X27NPT	H11	24

**KFAD02-2**

Thread	Seat	Length
M10X1--1/8X27NPT	H14	30.5

**KFAD03**

Thread	Seat	Length
M12X1.5--7/16X24	H13	27

**KFAD04**

Thread	Seat	Length
M11X1.5--3/8X24	H13	26

**KFAD05**

Thread	Seat	Length
1/2X20--ZG1/8X28	H13	25

**KFAD06**

Thread	Seat	Length
M10X1.25--3/8X24	H13	25.5

**KFAD07**

Thread	Seat	Length
M10X1--3/8X24	H13	26

**KFAD08**

Thread	Seat	Length
1/2X20--9/16X18	H17	27

**KFAD08-2**

Thread	Seat	Length
1/2X20--9/16X18	H17	20

**KFAD09**

Thread	Seat	Length
1/2X20--9/16X18	H16	25.5

**KFAD10**

Thread	Seat	Length
5/8X18--1/2X20	H16	24

**KFAD11**

Thread	Seat	Length
1/2X20--7/16X24	H16	24

**KFAD12**

Thread	Seat	Length
9/16X20--3/8X24	H14	21.5

**KFAD13**

Thread	Seat	Length
9/16X18--3/8X24	H14	22.5

**KFAD14**

Thread	Seat	Length
9/16X18--7/16X24	H14	22.5

**KFAD15**

Thread	Seat	Length
1/2X20--3/8X24	H16	23

**KFAD15-2**

Thread	Seat	Length
3/8X24--1/2X20	H12.7	24

**KFAD16**

Thread	Seat	Length
1/2X20--3/8X24	H16	23

**KFAD17**

Thread	Seat	Length
7/16X20--7/16X20	H18	24.5

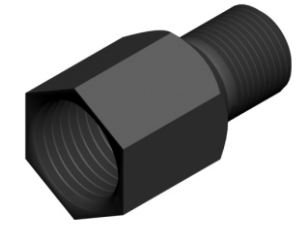
**KFAD18**

Thread	Seat	Length
1/2X20--1/8X27NPT	H14	27

**KFAD19**

Thread	Seat	Length
5/8X18--1/2X20	H19	25

**KFAD20**

Thread	Seat	Length
M16X1.5--5/8X18	H19	31.5

**KFAD21**

Thread	Seat	Length
M10X1--3/8X24	H13	26

**KFAD21-2**

Thread	Seat	Length
M10X1--3/8X24	H13	20

**KFAD21-3**

Thread	Seat	Length
3/8X24--1/2X20	H13	24

**KFAD22**

Thread	Seat	Length
M10X1--3/8X24	H13	26

**KFAD23**

Thread	Seat	Length
7/16X20--7/16X24	H16	24

**KFAD23-2**

Thread	Seat	Length
7/16X24--7/16X20	H16	24

**KFAD24**

Thread	Seat	Length
3/8X24--ZG1/8X28	H13	21.5

**KFAD25**

Thread	Seat	Length
M10X1--3/8X24	H13	46

**KFAD26**

Thread	Seat	Length
M10X1--3/8X24	H13	25

**KFAD27**

Thread	Seat	Length
M10X1--3/8X24	H28	17

**KFAD28**

Thread	Seat	Length
7/16X24--3/8X24	H14	18.5

**KFAD29**

Thread	Seat	Length
3/8X24--3/8X24	H14	23

**KFAD29-2**

Thread	Seat	Length
3/8X24--7/16X24	H14	23

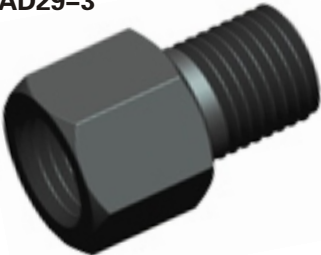
**KFAD29-3**

Thread	Seat	Length
3/8X24--3/8X24	H13	22

**KFAD30**

Thread	Seat	Length
3/8X24--3/8X24	H11	28.5

**KFAD30-2**

Thread	Seat	Length
3/8X24--3/8X24	H14	33.5

**KFAD31**

Thread	Seat	Length
M12X1--M10X1	H16	25

**KFAD32**

Thread	Seat	Length
M10X1--ZG1/4X19	H14	27

**KFAD33**

Thread	Seat	Length
M10X1--3/8X24	H13	37

**KFAD34**

Thread	Seat	Length
M10X1--ZG1/4X19	H14	27

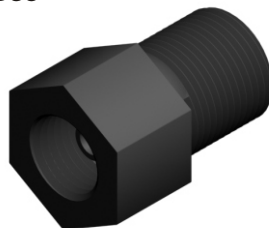
**KFAD35**

Thread	Seat	Length
1/2X18--1/4X18NPT	H16	25

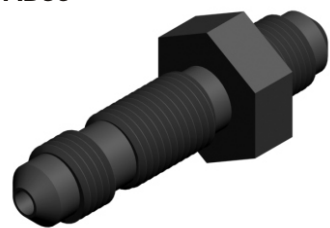
**KFAD36**

Thread	Seat	Length
3/8X24--3/8X24	H13	47

**KFAD36-2**

Thread	Seat	Length
M10X1-M10X1-M10X1	H16	47

**KFAD37**

Thread	Seat	Length
M10X1--3/8X24	H14	27.5

**KFAD38**

Thread	Seat	Length
M12X1--M10X1	H17	26

**KFAD39**

Thread	Seat	Length
M18X1.5--M18X1.5	H18	32

**KFAD40**

Thread	Seat	Length
M10X1--3/8X24	H17	28

**KFAD41**

Thread	Seat	Length
M10X1--M10X1	H11	29

**KFAD42**

Thread	Seat	Length
M14X1.5--M14X1.5	H14	38

**KFAD43**

Thread	Seat	Length
M10X1--M10X1	H10	30.5

**KFAD44**

Thread	Seat	Length
M12X1.25--M10X1	H14	32

**KFAD45**

Thread	Seat	Length
5/8X18--5/8X18	H16	36

**KFAD45-2**

Thread	Seat	Length
M22X1.5--M22X1.5	H27	43

**KFAD46**

Thread	Seat	Length
7/16X24--3/8X24	H13	22

**KFAD46-2**

Thread	Seat	Length
3/8X24--7/16X24	H13	18

**KFAD47**

Thread	Seat	Length
M10X1--3/8X24	13	25

**KFAD48**

Thread	Seat	Length
M10X1--M11X1.5	H11	25

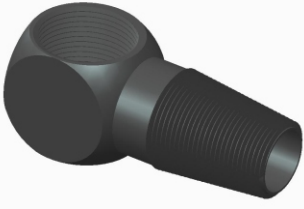

**KFAD49**

Thread	Seat	Length
1/8X27NPTF--1/8X27NPTF	W13	26

**KFAD50**

Thread	Seat	Length
1/8X27NPTF--1/8X27NPTF	W13	26

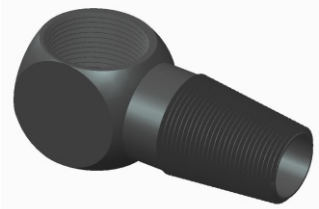
**KFAD51**

Thread	Seat	Length
1/4X18NPTF--1/4X18NPTF	W19	34.5

**KFAD52**

Thread	Seat	Length
1/8X27NPT--1/8X27NPT	H11	23

**KFAD53**

Thread	Seat	Length
1/2X20--1/8X27NPT	H13	23

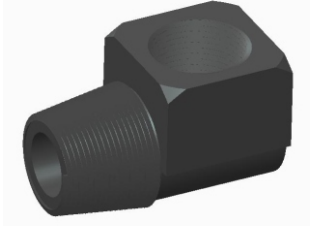
**KFAD54**

Thread	Seat	Length
1/8X27NPT--1/8X27NPT	W13	

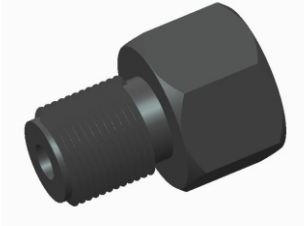
**KFAD55**

Thread	Seat	Length
3/8X24--7/16X24	H14	21

**KFAD55-2**

Thread	Seat	Length
7/16X24--1/8X28	H13	17.7

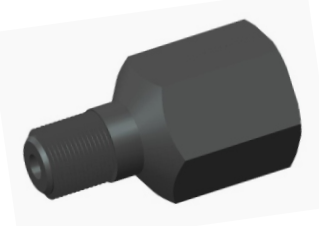
**KFAD56**

Thread	Seat	Length
1/8X27NPTF--1/4X28	H12.7	22

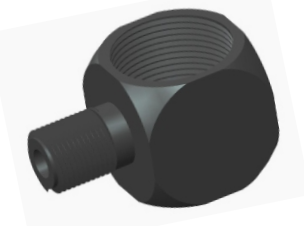
**KFAD57**

Thread	Seat	Length
1/8X27NPTF--1/4X28	H12.7	21

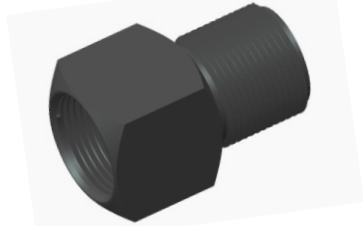
**KFAD58**

Thread	Seat	Length
1/8X27NPTF--1/4X28--1/8X27NPSM	H12.7	22.5

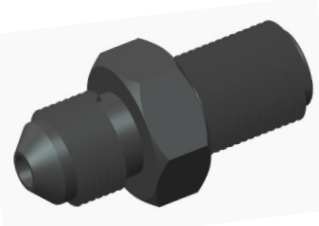
**KFAD59**

Thread	Seat	Length
3/8X24--3/8X24	H12.7	31

**KFAD59-2**

Thread	Seat	Length
3/8X24--3/8X24	H11	32

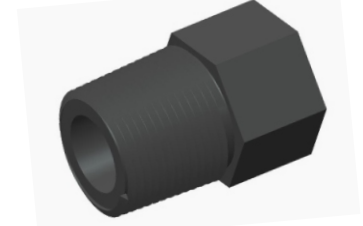
**KFAD60**

Thread	Seat	Length
1/8X27NPT--1/8X27NPT	H11	17

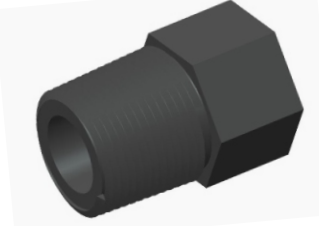
**KFAD60-2**

Thread	Seat	Length
1/4-19NPTF--3/8-19NPTF	H11	17

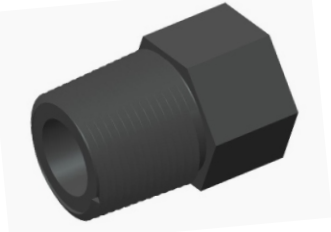
**KFAD60-3**

Thread	Seat	Length
1/8X27NPT--1/8X27NPT	H11	17

**KFAD61**

Thread	Seat	Length
5/8X18--5/8X18	H19	41

**KFAD62**

Thread	Seat	Length
ZG1/8--5/16X24	H10	24.5

**KFAD63**

Thread	Seat	Length
M10X1--M10X1	H11	20.4

**KFAD64**

Thread	Seat	Length
M16X1.5--M16X1.5	H24	38

**KFAD64-2**

Thread	Seat	Length
M16X1.5--M22X1.5	H27	29

**KFAD65**

Thread	Seat	Length
1/8X27NPT--1/8X27NPT	H14	20

**KFAD66**

Thread	Seat	Length
7/16X20--7/16X20	H13	43

**KFAD67**

Thread	Seat	Length
7/16X20--3/8X24	H16	32.3

**KFAD68**

Thread	Seat	Length
1/2X20--1/2X20	H14	38

**KFAD69**

Thread	Seat	Length
1/4X19NPT	H16	25

**KFAD69-2**

Thread	Seat	Length
1/2X20	H15.2	24.5

**KFAD69-3**

Thread	Seat	Length
3/8-19NPSM	24	30.1

**KFAD70**

Thread	Seat	Length

**KFAD71**

Thread	Seat	Length
3/8X24---M10X1	H13	25.5

**KFAD72**

Thread	Seat	Length
M10X1---M12X1	H13.5	25.9

**KFAD73**

Thread	Seat	Length
7/16X24---M12X1	H17.5	27.5

**KFAD74**

Thread	Seat	Length
3/8X24---7/16X24	H13.8	25

**KFAD75**

Thread	Seat	Length
3/8X24---M10X1	H14.2	34.8

**KFAD76**

Thread	Seat	Length
1/2X20---9/16X18	H15.9	30.2

**KFAD77**

Thread	Seat	Length
5/8X18	H17.5	30.7

**KFAD78**

Thread	Seat	Length
11/16X18---9/16X18	H19	33.3

**KFAD79**

Thread	Seat	Length
M16X1.5---9/16X18	H19	39.3

**KFAD80**

Thread	Seat	Length
M18X1.5---9/16X18	H19	39.3

**KFAD81**

Thread	Seat	Length
3/8X24---3/8X24	H14.2	30.6

**KFAD82**

Thread	Seat	Length
3/8X24---7/16X24	H14.2	33

**KFAD83**

Thread	Seat	Length
3/8X24---7/16X24	H14.2	33

**KFAD84**

Thread	Seat	Length
3/8X24---1/2X20	H14.2	32.4

**KFAD85**

Thread	Seat	Length
3/8X24---9/16X18	H15.8	30

**KFAD86**

Thread	Seat	Length
1/8X27---3/8X24	H11.1	28.8

**KFAD87**

Thread	Seat	Length
3/8X24---7/16X24	H14.3	28.19

**KFAD88**

Thread	Seat	Length
7/16X24---3/8X24	H14	21

**KFAD89**

Thread	Seat	Length
3/8X24---3/8X24	H14.2	31

**KFAD90**

Thread	Seat	Length
M8X1---M10X1	H17	25.75

**KFAD91**

Thread	Seat	Length
M8X1---M10X1	H14	26

**KFAD92**

Thread	Seat	Length
M8X1---M10X1	H17	25.75

**KFAD93**

Thread	Seat	Length
M8X1	H12	28.3

**KFAD94**

Thread	Seat	Length
M8X1---M10X1	H12	29.75

**KFAD95**

Thread	Seat	Length
M8X1---M10X1	H12	48.75

**KFAD96**

Thread	Seat	Length
M8X1---M10X1	H12	38.75

**KFAD97**

Thread	Seat	Length
M10X1---M12X1	H17.4	27.5

**KFAD98**

Thread	Seat	Length
3/8X24---M12X1	H17.4	27.5

**KFAD99**

Thread	Seat	Length
7/16X24---M10X1	H16	25.9

**KFAD100**

Thread	Seat	Length
M10X1---M12X1	H17.4	27.5

**KFAD101**

Thread	Seat	Length
3/8X24---M10X1	H14	25.9

**KFAD102**



Thread	Seat	Length
M10X1---M10X1	H14	25.9

**KFAD103**



Thread	Seat	Length
1/8X28---3/8X24	H14.3	26

**KFAD104**



Thread	Seat	Length
3/8X24---3/8X24	H14.3	26

**KFAD105**



Thread	Seat	Length
3/8X24---3/8X24	H14.3	26

**KFAD106**



Thread	Seat	Length
M10X1.5---M10X1	H14	25

**KFAE01**



OD	ID	Thickness
25	17.8	1.5

**KFAE01-2**



OD	ID	Thickness
23	16	1.5

**KFAE01-3**



OD	ID	Thickness

**KFAE02**

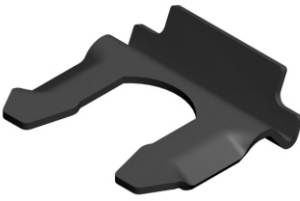

OD	ID	Thickness

**KFAE02-2**



OD	ID	Thickness

**KFAE02-3**

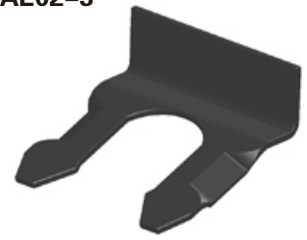

OD	ID	Thickness

**KFAE03**



OD	ID	Thickness

**KFAE03-2**



OD	ID	Thickness

**KFAE04**

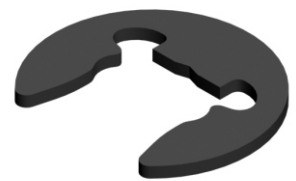

OD	ID	Thickness
23.6		1

**KFAE04-2**

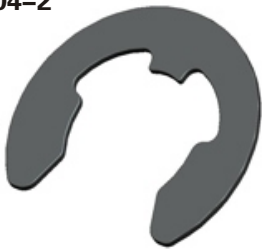

OD	ID	Thickness

**KFAE04-3**

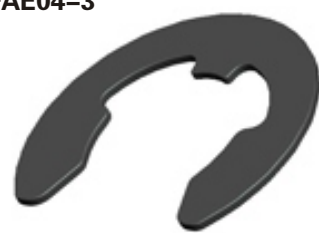

OD	ID	Thickness

**KFAE04-4**



OD	ID	Thickness

**KFAE05**



OD	ID	Thickness

**KFAE06**

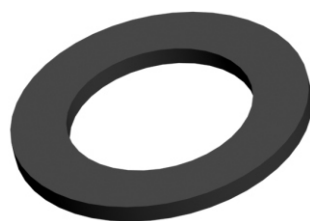

OD	ID	Thickness

**KFAE06-2**

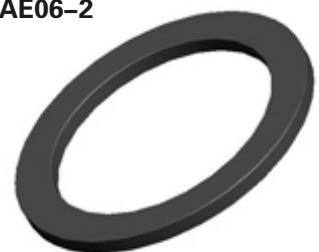

OD	ID	Thickness
30	22.5	1.6

**KFAE06-3**

OD	ID	Thickness
29	13	1.7

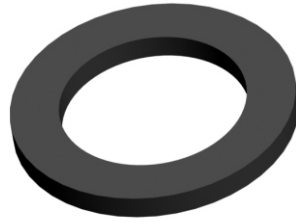
**KFAE07**

OD	ID	Thickness
16	10.2	1.4

**KFAE07-2**

OD	ID	Thickness
16	10	0.5

**KFAE07-3**

OD	ID	Thickness
16	10	1.2

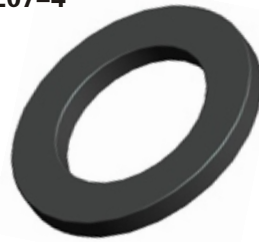
**KFAE07-4**

OD	ID	Thickness
16	10	1.4

**KFAE07-5**

OD	ID	Thickness
20	11.4	1.5

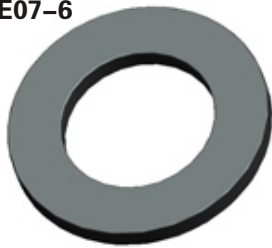
**KFAE07-6**

OD	ID	Thickness
17	10	1.5

**KFAE07-7**

OD	ID	Thickness
16	10	1.8

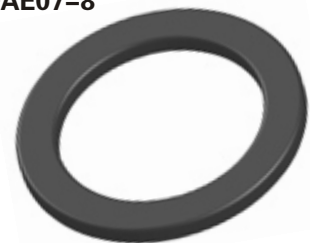
**KFAE07-8**

OD	ID	Thickness
17	12	1.2

**KFAE07-9**

OD	ID	Thickness
14.85	10.25	1.2

**KFAE07-10**

OD	ID	Thickness
16	10	1

**KFAE07-11**

OD	ID	Thickness
18	11	1.4

**KFAE07-12**

OD	ID	Thickness
18	12	1.3

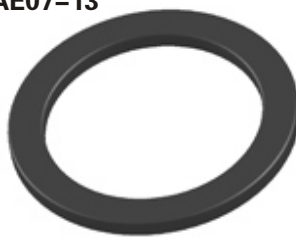
**KFAE07-13**

OD	ID	Thickness
22	15.5	2

**KFAE07-14**

OD	ID	Thickness
21	14.5	2

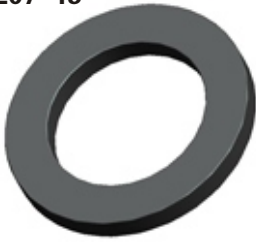
**KFAE07-15**

OD	ID	Thickness
20	13	2

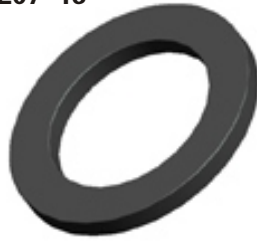
**KFAE07-16**

OD	ID	Thickness
24	16	2

**KFAE07-17**

OD	ID	Thickness
17	12	1.4

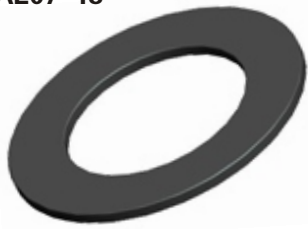
**KFAE07-18**

OD	ID	Thickness
20.6	12.7	0.8

**KFAE07-19**

OD	ID	Thickness
17	10.3	1.2

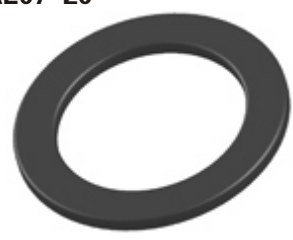
**KFAE07-20**

OD	ID	Thickness
17.5	11.5	1

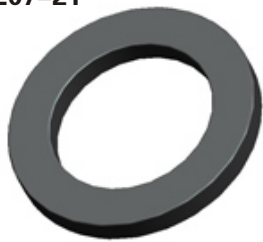
**KFAE07-21**

OD	ID	Thickness
15.5	10.2	1.6

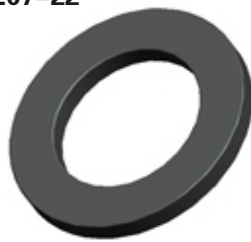
**KFAE07-22**

OD	ID	Thickness
16.5	10.3	1.5

**KFAE07-23**

OD	ID	Thickness
16.8	12.3	1.2

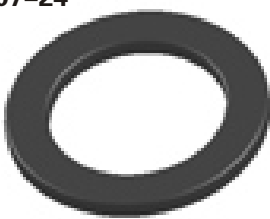
**KFAE07-24**

OD	ID	Thickness
15.5	10.2	1.2

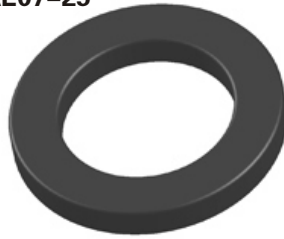
**KFAE07-25**

OD	ID	Thickness
15.5	10.2	2

**KFAE07-26**

OD	ID	Thickness
24	15.9	1.5

**KFAE07-27**

OD	ID	Thickness
23.8	14	1.4

**KFAE07-28**

OD	ID	Thickness
14.8	10.2	1

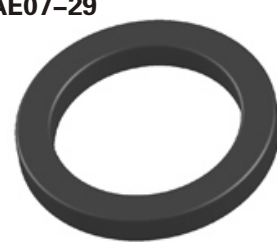
**KFAE07-29**

OD	ID	Thickness
16	11.7	2



**KFAE07-30**

OD	ID	Thickness
14.148	6.5	1.42

**KFAE07-31**

OD	ID	Thickness
15.748	8.1	1.41

**KFAE07-32**

OD	ID	Thickness
20.637	9.6	1.82

**KFAE07-33**

OD	ID	Thickness
16	10	2

**KFAE07-34**

OD	ID	Thickness
14	10	2

**KFAE07-35**

OD	ID	Thickness
15	10	1

**KFAE07-36**

OD	ID	Thickness
12.5	9.5	1

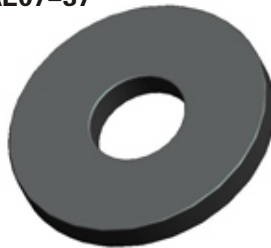
**KFAE07-37**

OD	ID	Thickness
13	4.75	1.5

**KFAE07-38**

OD	ID	Thickness
17.5	11.5	0.79

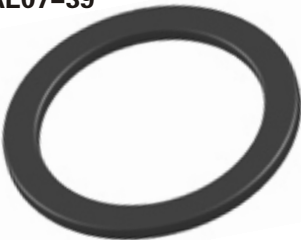
**KFAE07-39**

OD	ID	Thickness
18	13	0.9

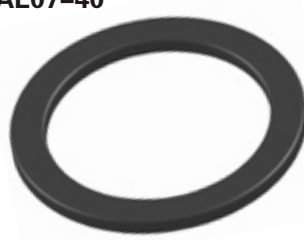
**KFAE07-40**

OD	ID	Thickness
20.3	15.2	0.8

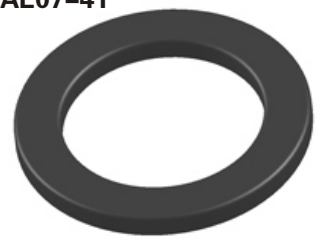
**KFAE07-41**

OD	ID	Thickness
14.7	10.2	1.3

**KFAE07-42**

OD	ID	Thickness
48	41.6	1.6

**KFAE07-43**

OD	ID	Thickness
20.3	11.5	1.56

**KFAE07-44**

OD	ID	Thickness
16.8	10.3	1.36

**KFAE07-45**

OD	ID	Thickness
20.5	15.2	0.8

**KFAE07-46**

OD	ID	Thickness
20.5	12.8	0.8

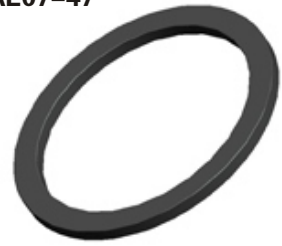
**KFAE07-47**

OD	ID	Thickness
34.6	28.4	1.7

**KFAE07-48**

OD	ID	Thickness
17	11.3	1.2

**KFAE07-49**

OD	ID	Thickness
17	11	1

**KFAE07-50**

OD	ID	Thickness
20.3	13	0.8

**KFAE07-51**

OD	ID	Thickness
20.3	15.4	0.8

**KFAE07-52**

OD	ID	Thickness
17.2	11.5	0.9

**KFAE07-53**

OD	ID	Thickness
13	8	1.5

**KFAE07-54**

OD	ID	Thickness
26	22	0.8

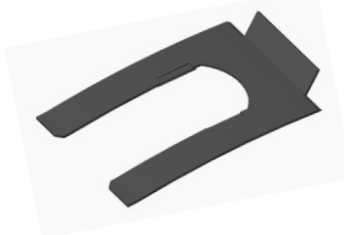
**KFAE08**

OD	ID	Thickness

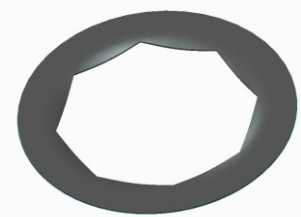
**KFAE09**

OD	ID	Thickness

**KFAE10**

OD	ID	Thickness

**KFAE11**

OD	ID	Thickness

**KFAE11-2**

OD	ID	Thickness

**KFAE12**

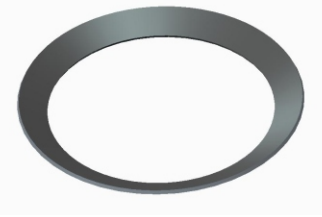

OD | ID | Thickness

**KFAE13**



OD | ID | Thickness

**KFAE14**



OD | ID | Thickness

**KFAE15**



OD | ID | Thickness

**KFAE16**



OD | ID | Thickness

**KFAE17**



OD | ID | Thickness

**KFAE18**



OD | ID | Thickness

**KFAE19**

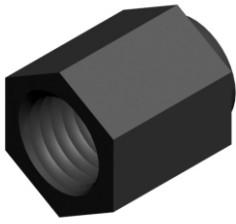

OD | ID | Thickness

**KFAN01**

Thread	Seat	Length	Hole
M10X1	H13	16	Φ5

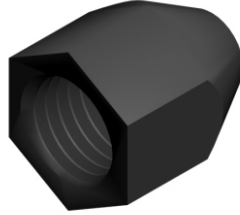
**KFAN02**

Thread	Seat	Length	Hole
M10X1	H13	17	Φ5

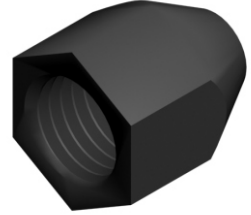
**KFAN02-2**

Thread	Seat	Length	Hole
M10X1	H12	17	Φ5

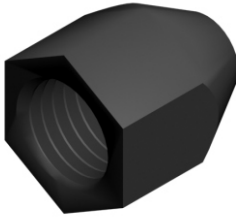
**KFAN02-3**

Thread	Seat	Length	Hole
M12X1	H16	18	3/16"

**KFAN03**

Thread	Seat	Length	Hole
7/16X24	H14	19	Φ6.6

**KFAN04**

Thread	Seat	Length	Hole
3/8X24	H14	19	Φ5

**KFAN04-2**

Thread	Seat	Length	Hole
M11X1.25	H14.5	14.5	Φ5

**KFAN04-3**

Thread	Seat	Length	Hole
7/16X20	H15	14.5	1/4"

**KFAN04-4**

Thread	Seat	Length	Hole
M12X1.25	H16	18.5	Φ5

**KFAN04-5**

Thread	Seat	Length	Hole
7/16X20	H15	18.5	1/4"

**KFAN04-6**

Thread	Seat	Length	Hole
3/8X24	H15	19.5	Φ5

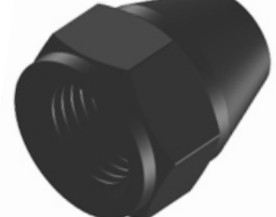
**KFAN04-7**

Thread	Seat	Length	Hole
3/8X24	H14	17	Φ5

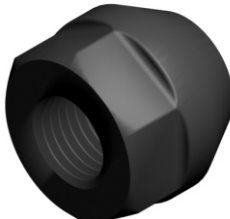
**KFAN05**

Thread	Seat	Length	Hole
M12X1.5	H21	19.5	

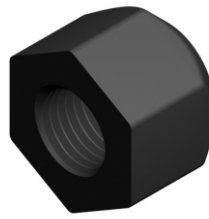
**KFAN06**

Thread	Seat	Length	Hole
M12X1.25	H21	16	

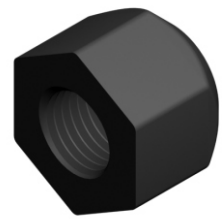
**KFAN07**

Thread	Seat	Length	Hole
M12X1.5	H21	21	

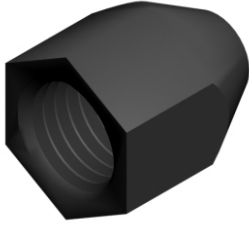
**KFAN08**

Thread	Seat	Length	Hole
3/8X24	H17	13	Φ5

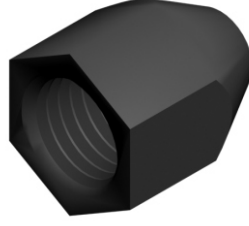
**KFAN08-2**

Thread	Seat	Length	Hole
3/8X24	H12	13	Φ5

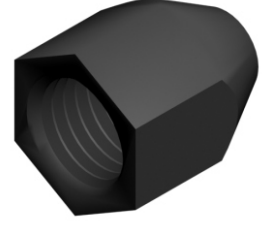
**KFAN08-3**

Thread	Seat	Length	Hole
3/8X24	H14	13	Φ5

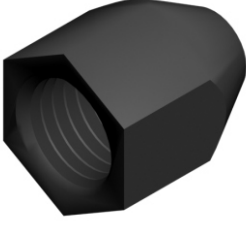
**KFAN08-4**

Thread
M10X1

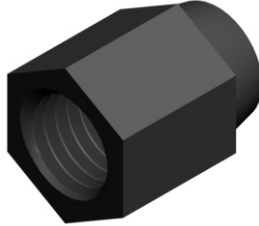
**KFAN09**

Thread	Seat	Length	Hole
3/8X24	H17	13	Φ5

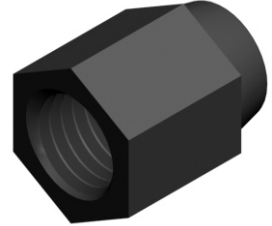
**KFAN09-2**

Thread	Seat	Length	Hole
M12X1	H15	21.5	Φ5

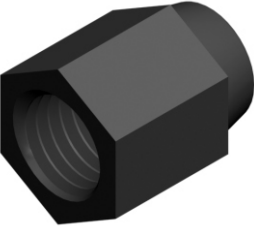
**KFAN09-3**

Thread	Seat	Length	Hole
M10X1	H13	21.5	Φ5

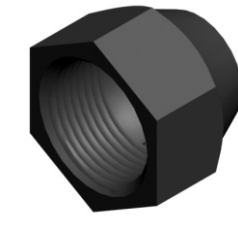
**KFAN10**

Thread	Seat	Length	Hole
M12X1.25	H15	12.5	Φ5

**KFAN10-2**

Thread	Seat	Length	Hole
M12X1.25	H16	12.5	Φ5

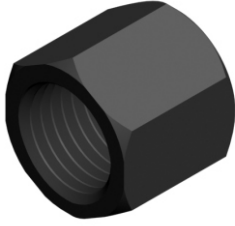
**KFAN11**

Thread	Seat	Length	Hole
M12X1.5	H14	14	Φ6.6

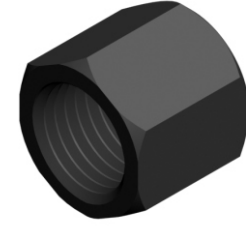
**KFAN11-2**

Thread	Seat	Length	Hole
M10X1	H14	13	Φ6.6

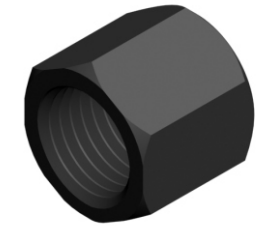
**KFAN11-3**

Thread	Seat	Length	Hole
M12X1.5	H16.8	14.6	Φ6.6

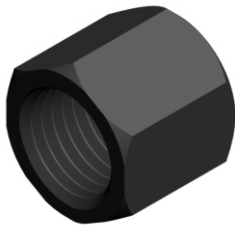
**KFAN11-4**

Thread	Seat	Length	Hole
M10X1	H14	15	Φ5.05

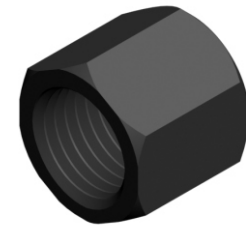
**KFAN11-5**

Thread	Seat	Length	Hole
M10X1	H14	16.5	3/16"

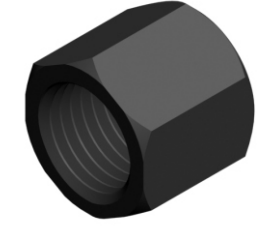
**KFAN11-6**

Thread	Seat	Length	Hole
3/8X28	H11	10	Φ6.6

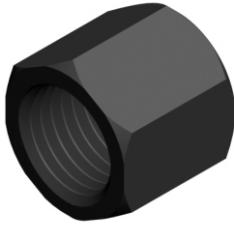
**KFAN11-7**

Thread	Seat	Length	Hole
3/8X24	H115	9	Φ6.6

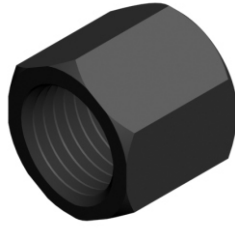
**KFAN11-8**

Thread	Seat	Length	Hole
M8X1	H19.5	8	Φ6.6

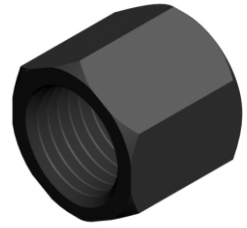
**KFAN11-9**

Thread	Seat	Length	Hole
M8X1	H11	10	Φ6.6

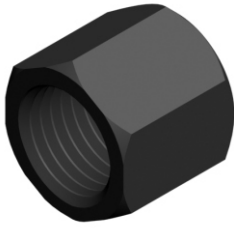
**KFAN11-10**

Thread	Seat	Length	Hole
3/8X28	H11	8	Φ6.6

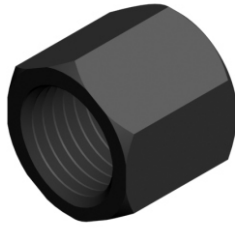
**KFAN11-11**

Thread	Seat	Length	Hole
3/8X28	H11	9.5	3/16"

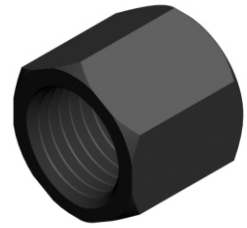
**KFAN11-12**

Thread	Seat	Length	Hole
M10X1.5	H15	13	Φ6.6

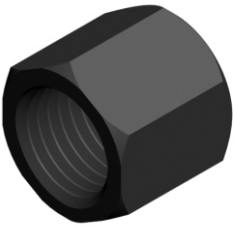
**KFAN11-13**

Thread	Seat	Length	Hole
7/16X24	H15	12	Φ6.6

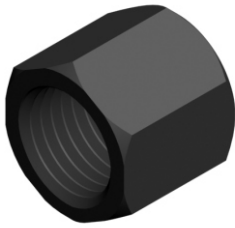
**KFAN11-14**

Thread	Seat	Length	Hole
1/2X24	H15	12	Φ6.6

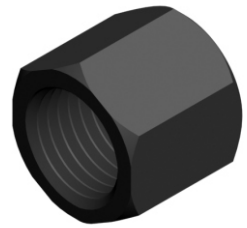
**KFAN11-15**

Thread	Seat	Length	Hole
3/8X28	H13	11	Φ6.6

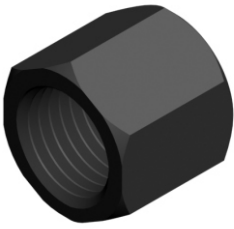
**KFAN11-16**

Thread	Seat	Length	Hole
3/8X28	H14	11.3	1/4"

**KFAN12**

Thread	Seat	Length	Hole
3/8X24	H13	16	Φ7

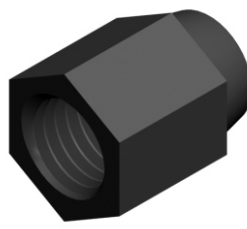
**KFAN13**

Thread	Seat	Length	Hole
M10X1	H17	13	Φ5

**KFAN13-2**

Thread	Seat	Length	Hole
3/8X24	H17	13	Φ5

**KFAN14**

Thread	Seat	Length	Hole
7/16X24	H19	14	Φ6.6

**KFAN14-2**

Thread	Seat	Length	Hole
M12 x 1	H14	24	Φ6

**KFAN14-3**

Thread	Seat	Length	Hole
M12X1.5	H17	25	Φ7

**KFAN14-4**

Thread	Seat	Length	Hole
5/8X18	H21	29	Φ11

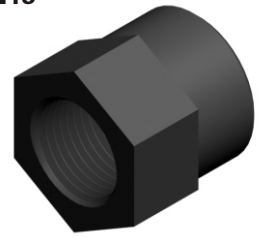
**KFAN15**

Thread	Seat	Length	Hole
3/8X28	H14	14	Φ7

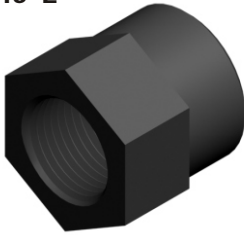
**KFAN15-2**

Thread	Seat	Length	Hole
M10X1	H14	14	Φ7

**KFAN16**

Thread	Seat	Length	Hole
3/8X32	H11	16	Φ7

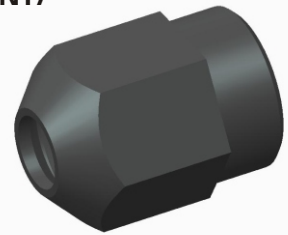
**KFAN17**

Thread	Seat	Length	Hole
3/8X24	H12	16	Φ5

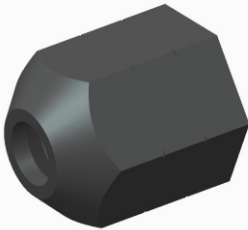
**KFAN18**

Thread	Seat	Length	Hole
M10X1	H13	16	Φ5

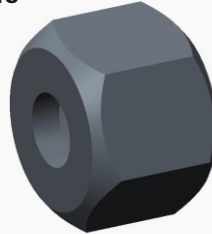
**KFAN19**

Thread	Seat	Length	Hole
1X14	H30	23	Φ20

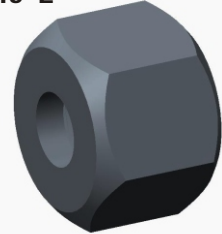
**KFAN19-2**

Thread	Seat	Length	Hole
1/2X20	H16	14.3	5/16"

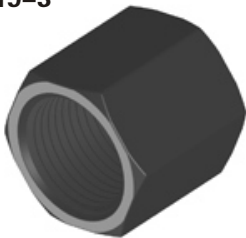
**KFAN19-3**

Thread	Seat	Length	Hole
1/2X20	H16	16	Φ8

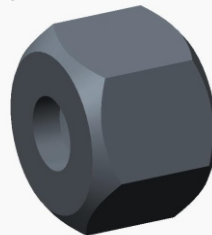
**KFAN20**

Thread	Seat	Length	Hole
M14X1.5	H17	15	Φ6.6

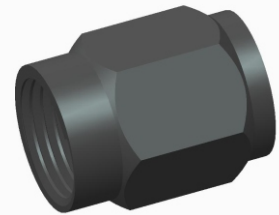
**KFAN21**

Thread	Seat	Length	Hole
3/8X24	H11	15	

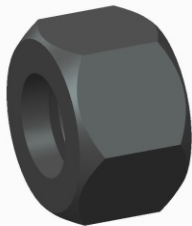
**KFAN22**

Thread	Seat	Length	Hole
M18X1.5	H22	15	Φ12.8

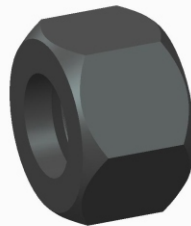
**KFAN22-2**

Thread	Seat	Length	Hole
5/8X18	H19	15	Φ9.8

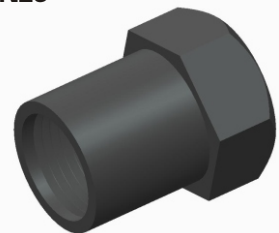
**KFAN23**

Thread	Seat	Length	Hole
M10X1	H13.7	15	

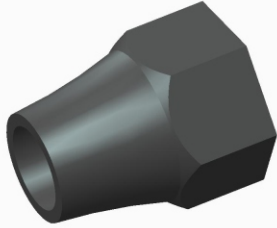
**KFAN24**

Thread	Seat	Length	Hole
9/16X24	H17.5	22.4	Φ6.6

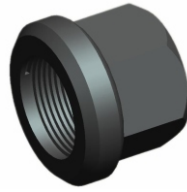
**KFAN25**

Thread	Seat	Length	Hole
M12X1.25	H17.8	17	

**KFAN26**

Thread	Seat	Length	Hole
1/2X20	H16	12	3/18"

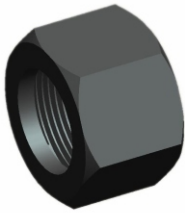
**KFAN27**

Thread	Seat	Length	Hole
3/8X19NPSM	H19	13	1/2"

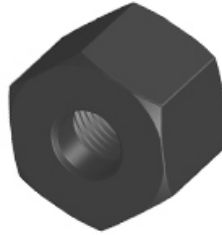
**KFAN27-2**

Thread	Seat	Length	Hole
M12X1.25	H17	13	Φ7

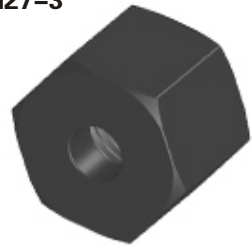
**KFAN27-3**

Thread	Seat	Length	Hole
7/16X24	H15	12	Φ5

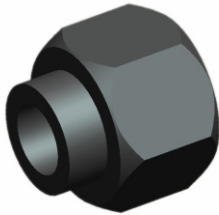
**KFAN28**

Thread	Seat	Length	Hole
9/16X28	H18	17	5/16"

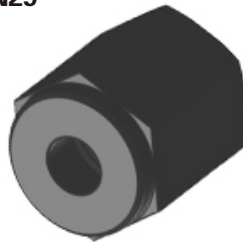
**KFAN29**

Thread	Seat	Length	Hole
M12X1	H14	17	Φ5

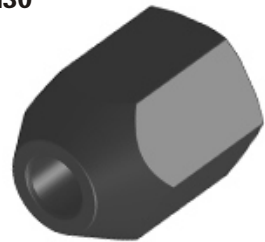
**KFAN30**

Thread	Seat	Length	Hole
3/8X24	H13	18	Φ5



**KFAS01**

Thread	Seat	Length	Hole
M10X1	H10	33.5	

**KFAS01-2**

Thread	Seat	Length	Hole
M10X1	H10	32	

**KFAS01-3**

Thread	Seat	Length	Hole
M10X1	H10	33	

**KFAS02**

Thread	Seat	Length	Hole
M7X1	H8	34	

**KFAS02-2**

Thread	Seat	Length	Hole
M7X1	H8	31.5	

**KFAS03**

Thread	Seat	Length	Hole
M8X1	H8	37.5	

**KFAS03-2**

Thread	Seat	Length	Hole
M8X1	H8	29	

**KFAS04**

Thread	Seat	Length	Hole
M10X1.25	H10	29	

**KFAS04-2**

Thread	Seat	Length	Hole
M10X1.25	H10	32	

**KFAS04-3**

Thread	Seat	Length	Hole
M10X1	H10	26	

**KFAS05**

Thread	Seat	Length	Hole
3/8X24	H10	30.5	

**KFAS05-2**

Thread	Seat	Length	Hole
3/8X24	H9.5	29.7	

**KFAS06**

Thread	Seat	Length	Hole
M8X1.25	H8	25.5	

**KFAS06-2**

Thread	Seat	Length	Hole
M8X1.25	H8	33.5	

**KFAS07**

Thread	Seat	Length	Hole
5/16X24	H8	25.5	

**KFAS07-2**

Thread	Seat	Length	Hole
5/16X24	H8	29	

**KFAS07-3**

Thread	Seat	Length	Hole
5/16X24	H9.5	30	

**KFAS08**

Thread	Seat	Length	Hole
1/4X28	H7	30	

**KFAS08-2**

Thread	Seat	Length	Hole
1/4X20	H7	23.5	

**KFAS08-3**

Thread	Seat	Length	Hole
1/4X28	H6	23.5	

**KFAS08-4**

Thread	Seat	Length	Hole
1/4X20	H9.5	24.7	

**KFAS09**

Thread	Seat	Length	Hole
7/16X20	H11	33	

**KFAS09-2**

Thread	Seat	Length	Hole
7/16X24	H11	36	

**KFAS09-3**

Thread	Seat	Length	Hole
7/16X20	H11	32	

**KFAS10**

Thread	Seat	Length	Hole
3/8X24	H10	33	

**KFAS10-2**

Thread	Seat	Length	Hole
3/8X24	H9	30	

**KFAS10-3**

Thread	Seat	Length	Hole
3/8X24	H10	33	

**KFAS10-4**

Thread	Seat	Length	Hole
3/8X24	H10	34	

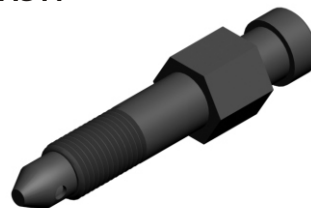
**KFAS11**

Thread	Seat	Length	Hole
M6x1	H8	37	

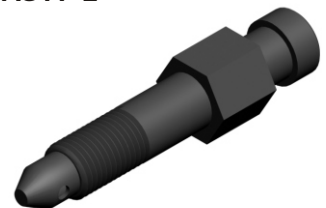
**KFAS11-2**

Thread	Seat	Length	Hole
M6x1	H7	37	

**KFAS12**

Thread	Seat	Length	Hole
M8X1.25	H8	36	

**KFAS12-2**

Thread	Seat	Length	Hole
M8X1.5	H8	36	

**KFAS12-3**

Thread	Seat	Length	Hole
M8X1.25	H9	41.5	

**KFAS13**

Thread	Seat	Length	Hole
M8X1	H8	36	

**KFAS14**

Thread	Seat	Length	Hole
1/4X28	H7	30	

**KFAS15**

Thread	Seat	Length	Hole
M10X1	H10	29	

**KFAS15-2**

Thread	Seat	Length	Hole
M10X1.5	H10	29	

**KFAS15-3**

Thread	Seat	Length	Hole
M10X1.5	H10	29	

**KFAS16**

Thread	Seat	Length	Hole
M10X1	H10	37	

**KFAS16-2**

Thread	Seat	Length	Hole
M10X1	H11	37	

**KFAS16-3**

Thread	Seat	Length	Hole
M10X1.5	H10	37	

**KFAS17**

Thread	Seat	Length	Hole
M10X1	H10	32.5	

**KFAS17-2**

Thread	Seat	Length	Hole
M10X1	H10	32	

**KFAS18**

Thread	Seat	Length	Hole
M10X1	H10	60	

**KFAS19**

Thread	Seat	Length	Hole
M8X1.25	H9	35.5	

**KFAS20**

Thread	Seat	Length	Hole
M6X1.25	H7	38	

**KFAS20-2**

Thread	Seat	Length	Hole
M6X1	H7	38	

**KFAS21**

Thread	Seat	Length	Hole
M8X1.25	H9	32	

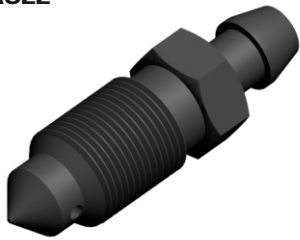
**KFAS22**

Thread	Seat	Length	Hole
M10X1	H10	34	

**KFAS23**

Thread	Seat	Length	Hole
M10X1	H14	34	

**KFAS24**

Thread	Seat	Length	Hole
M6X1.25	H7	30.5	

**KFAS24-2**

Thread	Seat	Length	Hole
M6X1	H7	21	

**KFAS24-3**

Thread	Seat	Length	Hole
M6X1	H7	29	

**KFAS25**

Thread	Seat	Length	Hole
M10X1	H11	30	

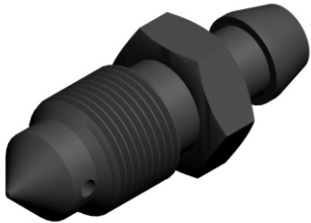
**KFAS25-2**

Thread	Seat	Length	Hole
M10X1	H11	36	

**KFAS26**

Thread	Seat	Length	Hole
M7X1	H7	29	

**KFAS26-2**

Thread	Seat	Length	Hole
M7X1	H7	21.7	

**KFAS26-3**

Thread	Seat	Length	Hole
M7X1	H7	26.2	

**KFAS27**

Thread	Seat	Length	Hole
M7X1	H7	30.5	

**KFAS27-2**

Thread	Seat	Length	Hole
M7X1	H7	32	

**KFAS28**

Thread	Seat	Length	Hole
M7X1	H7	38	

**KFAS28-2**

Thread	Seat	Length	Hole
M7X1	H7	38	

**KFAS29**

Thread	Seat	Length	Hole
M8X1	H9	33.5	

**KFAS29-2**

Thread	Seat	Length	Hole
M7X1	H9	33.5	

**KFAS30**

Thread	Seat	Length	Hole
M8X1.25	H8	24.5	

**KFAS30-2**

Thread	Seat	Length	Hole
M8X1.25	H8	26	

**KFAS31**

Thread	Seat	Length	Hole
M10X1	H10	38	

**KFAS32**

Thread	Seat	Length	Hole
M10X1.5	H10	29.2	

**KFAS33**

Thread	Seat	Length	Hole
1/4X20	H7	30	

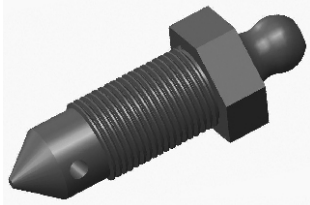
**KFAS34**

Thread	Seat	Length	Hole
1/2X20	H13	42	

**KFAS35**

Thread	Seat	Length	Hole
M12X1	H13	31.3	

**KFAS36**

Thread	Seat	Length	Hole
M10X1	H11	28	

**KFAS37**

Thread	Seat	Length	Hole
3/8X24	H11	36.8	

**KFAS38**

Thread	Seat	Length	Hole
M10X1	H11	37.3	

**KFAS39**

Thread	Seat	Length	Hole
M7X1	H8	30.3	

**KFAS40**

Thread	Seat	Length	Hole
1/4X28	H7	28.5	

**KFAS41**

Thread	Seat	Length	Hole
3/8X24	H11	34.3	

**KFAS42**

Thread	Seat	Length	Hole
3/8X24	H11	35	

**KFAS43**

Thread	Seat	Length	Hole
7/16X20	H11	36.5	

**KFAS43-2**

Thread	Seat	Length	Hole
7/16X20	H11	37	

**KFAS44**

Thread	Seat	Length	Hole
M10X1	H10	36.5	

**KFAS45**

Thread	Seat	Length	Hole
M12X1	H13	31.4	

**KFAS46**

Thread	Seat	Length	Hole
M8	H9	49	

**KFAS47**

Thread	Seat	Length	Hole
M8	H9	49	

**KFAS48**

Thread	Seat	Length	Hole
M8X1	H8	47.9	

**KFAS49**

Thread	Seat	Length	Hole
M10X1.25	H10	28	

**KFAS50**

Thread	Seat	Length	Hole
3/8X24	H10	31	

**KFAS51**

Thread	Seat	Length	Hole
1/4X28	H8	28	

**KFAS52**

Thread	Seat	Length	Hole
1/4X28	H8	28	

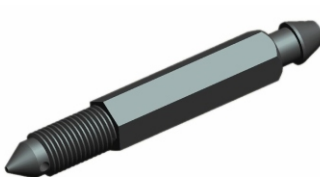
**KFAS53**

Thread	Seat	Length	Hole
1/4X28	H8	28	

**KFAS54**

Thread	Seat	Length	Hole
M10X1.5	H11	127.5	

**KFAS55**

Thread	Seat	Length	Hole
3/8X24	H9.5	127.5	

**KFAS56**

Thread	Seat	Length	Hole
5/16X24	H9.5	127.5	

**KFAS57**

Thread	Seat	Length	Hole
1/4X20	H7	31	

**KFAS58**

Thread	Seat	Length	Hole
M10X1	H10	33	

**KFAS59**

Thread	Seat	Length	Hole
1/4X28	H7	28	

**KFAT01**

Thread	Seat	Length	Tube
7/16X24	7/16"	14	3/16"

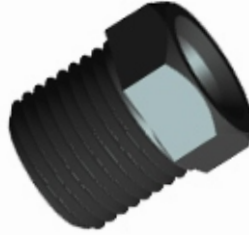
**KFAT01-2**

Thread	Seat	Length	Tube
7/16X24	H11	14.1	Φ6.5

**KFAT01-3**

Thread	Seat	Length	Tube
7/16X24	H14	14	Φ6.6

**KFAT01-4**

Thread	Seat	Length	Tube
7/16X24	H11	15	Φ6.7

**KFAT01-5**

Thread	Seat	Length	Tube
7/16X24	H11	17	Φ6.7

**KFAT01-6**

Thread	Seat	Length	Tube
7/16X24	H11.13	17.6	

**KFAT02**

Thread	Seat	Length	Tube
1/2X20	H14	16	3/16"

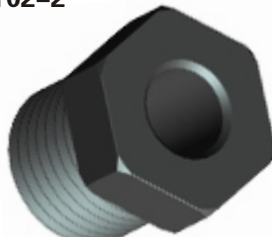
**KFAT02-2**

Thread	Seat	Length	Tube
1/2X20	H14.2	15.8	Φ6.5

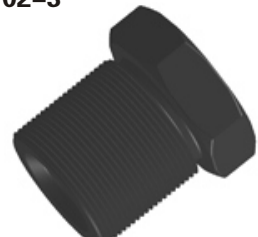
**KFAT02-3**

Thread	Seat	Length	Tube
1/2X20	H14.2	16	

**KFAT03**

Thread	Seat	Length	Tube
9/16X18	5/8"	16.5	3/16"

**KFAT03-2**

Thread	Seat	Length	Tube
9/16X18	H14	16.5	3/16"

**KFAT03-3**

Thread	Seat	Length	Tube
9/16X18	H14.2	17	Φ6.7

**KFAT04**

Thread	Seat	Length	Tube
9/16X18	9/16"	16	1/4"

**KFAT04-2**

Thread	Seat	Length	Tube
9/16X18	9/16"	16	3/16"

**KFAT04-3**

Thread	Seat	Length	Tube
9/16X18	H15.9	16	Φ5.2



**KFAT05**

Thread	Seat	Length	Tube
1/2X20	1/2"	16	1/4"

**KFAT05-2**

Thread	Seat	Length	Tube
1/2X20	H12.7	17	Φ6.7

**KFAT06**

Thread	Seat	Length	Tube
M10X1	H11	20	3/16"

**KFAT06-2**

Thread	Seat	Length	Tube
M10X1	H10	11	3/16"

**KFAT07**

Thread	Seat	Length	Tube
M10X1	H12	17	3/16"

**KFAT08**

Thread	Seat	Length	Tube
M13X1.5	H14	15.5	5/16"

**KFAT09**

Thread	Seat	Length	Tube
M11X1.5	H12	17.5	3/16"

**KFAT09-2**

Thread	Seat	Length	Tube
M10X1	H12	17.5	3/16"

**KFAT10**

Thread	Seat	Length	Tube
M12X1	H14	17.5	3/16"

**KFAT10-2**

Thread	Seat	Length	Tube
M12X1	H12	21	3/16"

**KFAT10-3**

Thread	Seat	Length	Tube
M12X1	H12	21	3/16"

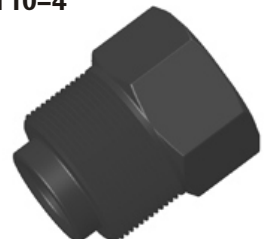
**KFAT10-4**

Thread	Seat	Length	Tube
7/16X24	H12.7	17	Φ5.2

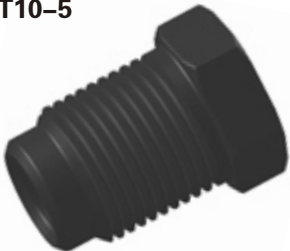
**KFAT10-5**

Thread	Seat	Length	Tube
M12X1	H13	17	Φ6.7

**KFAT11**

Thread	Seat	Length	Tube
M13X1.5	H14	18	3/16"

**KFAT12**

Thread	Seat	Length	Tube
M10X1	H10	16	3/16"

**KFAT12-2**

Thread	Seat	Length	Tube
M10X1	H10	16	Φ5.2

**KFAT13**

Thread	Seat	Length	Tube
M14X1.5	H14	23	5/16"

**KFAT13-2**

Thread	Seat	Length	Tube
M12X1	H12	23	5/16"

**KFAT13-3**

Thread	Seat	Length	Tube
M12X1	H13	23	5/16"

**KFAT13-4**

Thread	Seat	Length	Tube
M12X1	H13	24	5/16"

**KFAT13-5**

Thread	Seat	Length	Tube
7/16X20UNF	H12	23	5/16"

**KFAT13-6**

Thread	Seat	Length	Tube
M10X1	H10	16.7	5/16"

**KFAT13-7**

Thread	Seat	Length	Tube
7/16X20	H12	23	5/16"

**KFAT13-8**

Thread	Seat	Length	Tube
M14X1	H14	23	5/16"

**KFAT13-9**

Thread	Seat	Length	Tube
M14X1.25	H14	23	5/16"

**KFAT13-10**

Thread	Seat	Length	Tube
M12X1	H12	18	5/16"

**KFAT13-11**

Thread	Seat	Length	Tube
M12X1	H12.7	17	Φ6.7

**KFAT13-12**

Thread	Seat	Length	Tube
M12X1	H12.7	22	Φ5.2

**KFAT13-13**

Thread	Seat	Length	Tube
M12X1	H12	20	Φ6.7

**KFAT13-14**

Thread	Seat	Length	Tube
M12X1.25	H13	17	Φ6.7

**KFAT13-15**

Thread	Seat	Length	Tube
M12X1.25	H12	24	Φ6.7

**KFAT13-16**

Thread	Seat	Length	Tube
M10X1	H10	21.1	Φ5.1

**KFAT13-17**

Thread	Seat	Length	Tube
M14X1	H14	21	Φ6.5

**KFAT13-18**

Thread	Seat	Length	Tube
M14X1.25	H14	21	Φ6.5

**KFAT14**

Thread	Seat	Length	Tube
M14X1.5	H14	25	5/16"

**KFAT14-2**

Thread	Seat	Length	Tube
M14X1.5	H16	19	Φ8.2

**KFAT15**

Thread	Seat	Length	Tube
3/8X24	H11	19	3/16"

**KFAT15-2**

Thread	Seat	Length	Tube
3/8X24	H11	21	3/16"

**KFAT15-3**

Thread	Seat	Length	Tube
3/8X24	H9.5	20	Φ5.2

**KFAT15-4**

Thread	Seat	Length	Tube
3/8X24	H11	18	Φ5.2

**KFAT15-5**

Thread	Seat	Length	Tube
3/8X24	H11	20	Φ5.2

**KFAT16**

Thread	Seat	Length	Tube
M12X1	H13	21	5/16"

**KFAT16-2**

Thread	Seat	Length	Tube
M12X1	H12	20	Φ5.2

**KFAT17**

Thread	Seat	Length	Tube
M12X1.5	H13	17.5	1/4"

**KFAT18**

Thread	Seat	Length	Tube
M10X1.5	H10	20	3/16"

**KFAT18-2**

Thread	Seat	Length	Tube
M10X1.5	H12	17	Φ5.2

**KFAT19**

Thread	Seat	Length	Tube
M10X1	H13	19	3/16"

**KFAT20**

Thread	Seat	Length	Tube
M12X1	H14	20	1/4"

**KFAT20-2**

Thread	Seat	Length	Tube
M12X1	H12	20	1/4"

**KFAT21**

Thread	Seat	Length	Tube
M12X1.5	H14	21	3/16"

**KFAT21-2**

Thread	Seat	Length	Tube
M12X1.5	H14	20	Φ6.6

**KFAT22**

Thread	Seat	Length	Tube
M14X1.5	H15	21	1/4"

**KFAT23**

Thread	Seat	Length	Tube
M12X1.25	H14	20	3/16"

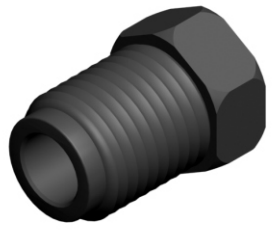
**KFAT24**

Thread	Seat	Length	Tube
M12X1.25	H13	20	1/4"

**KFAT24-2**

Thread	Seat	Length	Tube
M12X1.5	H12.7	21	1/4"

**KFAT24-3**

Thread	Seat	Length	Tube
7/16X20	H13	21	1/4"

**KFAT24-4**

Thread	Seat	Length	Tube
7/16X20	H11	24	Φ6.5

**KFAT25**

Thread	Seat	Length	Tube
M12X1.75	H13	20	5/16"

**KFAT26**

Thread	Seat	Length	Tube
M12X1.75	H13	26	1/4"

**KFAT27**

Thread	Seat	Length	Tube
M10X1	H11	16	3/16"

**KFAT27-2**

Thread	Seat	Length	Tube
M10X1	H11	17.5	3/16"

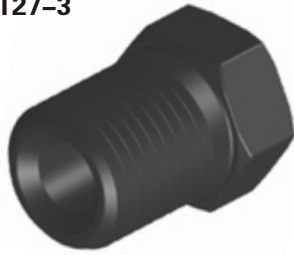
**KFAT27-3**

Thread	Seat	Length	Tube
M10X1	H11	16	Φ5.2

**KFAT28**

Thread	Seat	Length	Tube
M12X1	H13	20	3/16"

**KFAT28-2**

Thread	Seat	Length	Tube
M12X1	H13	20	Φ6.3

**KFAT28-3**

Thread	Seat	Length	Tube
M12X1	H13	20	Φ5.2

**KFAT28-4**

Thread	Seat	Length	Tube
M12X1	H13	20	Φ6.7

**KFAT29**

Thread	Seat	Length	Tube
M12X1.25	H13	20	3/16"

**KFAT29-2**

Thread	Seat	Length	Tube
M12X1.25	H13	20	Φ6.5

**KFAT30**

Thread	Seat	Length	Tube
9/16X18	H16	20	3/16"

**KFAT31**

Thread	Seat	Length	Tube
M10X1	H11	25	3/16"

**KFAT32**

Thread	Seat	Length	Tube
M10X1	H11	20	3/16"

**KFAT32-2**

Thread	Seat	Length	Tube
M10X1	H11	19.3	3/16"

**KFAT32-3**

Thread	Seat	Length	Tube
7/16X24	H11	21	Φ6.6

**KFAT32-4**

Thread	Seat	Length	Tube
M10X1	H11	21	Φ5.2

**KFAT33**

Thread	Seat	Length	Tube
M10X1	H11	19.3	3/16"

**KFAT33-2**

Thread	Seat	Length	Tube
M12X1	H12	19.3	3/16"

**KFAT33-3**

Thread	Seat	Length	Tube
M8X1.25	H8	19.3	3/16"

**KFAT33-4**

Thread	Seat	Length	Tube
M9X1.25	H10	19.3	3/16"

**KFAT34**

Thread	Seat	Length	Tube
7/16X24	H11	14.5	5/16"

**KFAT35**

Thread	Seat	Length	Tube
7/16X24	H11	15	3/16"

**KFAT36**

Thread	Seat	Length	Tube
7/16X20	H11	23	5/16"

**KFAT36-2**

Thread	Seat	Length	Tube
3/8X20	H11	23	5/16"

**KFAT36-3**

Thread	Seat	Length	Tube
3/8X20	H10	19	Φ4.8

**KFAT37**

Thread	Seat	Length	Tube
3/8X24	H10	14.2	3/16"

**KFAT37-2**

Thread	Seat	Length	Tube
3/8X24	H11	14.2	3/16"

**KFAT37-3**

Thread	Seat	Length	Tube
3/8X24	H9.5	14.2	3/16"

**KFAT37-4**

Thread	Seat	Length	Tube
3/8X24	H11	14.2	Φ5.2

**KFAT37-5**

Thread	Seat	Length	Tube
3/8X24	H11	14	Φ6.6

**KFAT37-6**

Thread	Seat	Length	Tube
3/8X24	H11	15	Φ5.2

**KFAT38**

Thread	Seat	Length	Tube
3/8X20	H11	23	3/16"

**KFAT38-2**

Thread	Seat	Length	Tube
1/2X20	H12.7	24	Φ8.2

**KFAT38-3**

Thread	Seat	Length	Tube
1/2X20	H14	27	Φ6.5

**KFAT38-4**

Thread	Seat	Length	Tube
3/8X24	H11	28	Φ5.2

**KFAT38-5**

Thread	Seat	Length	Tube
M10X1	H11	22	Φ5.2

**KFAT39**

Thread	Seat	Length	Tube
M10X1.25	H10	20	3/16"

**KFAT39-2**

Thread	Seat	Length	Tube
M10X1.25	H11	20	3/16"

**KFAT39-3**

Thread	Seat	Length	Tube
3/8X24	H9.5	21	Φ5.5

**KFAT39-4**

Thread	Seat	Length	Tube
3/8X24	H10	21	Φ5

**KFAT40**

Thread	Seat	Length	Tube
1/2X20	H13	16	5/16"

**KFAT40-2**

Thread	Seat	Length	Tube
1/2X20	H13	18	3/16"

**KFAT40-3**

Thread	Seat	Length	Tube
1/2X20	H12.7	16	3/16"

**KFAT40-4**

Thread	Seat	Length	Tube
1/2X20	H14.2	19	Φ5.2

**KFAT40-5**

Thread	Seat	Length	Tube
1/2X20	H14.2	19	Φ5.2

**KFAT41**

Thread	Seat	Length	Tube
7/16X20	H11	15	3/16"

**KFAT42**

Thread	Seat	Length	Tube
M10X1	H10	18	3/16"

**KFAT42-2**

Thread	Seat	Length	Tube
M10X1	H10	17.2	3/16"

**KFAT42-3**

Thread	Seat	Length	Tube
M10X1	H10	18	3/16"

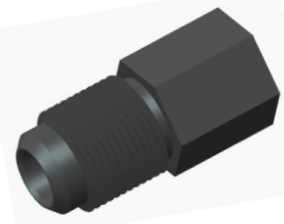
**KFAT43**

Thread	Seat	Length	Tube
M10X1	H11	21	3/16"

**KFAT43-2**

Thread	Seat	Length	Tube
M10X1	H10	21	3/16"

**KFAT43-3**

Thread	Seat	Length	Tube
3/8X24	H9.5	22	3/16"

**KFAT43-4**

Thread	Seat	Length	Tube
7/16X24	H11	23	1/4"

**KFAT43-5**

Thread	Seat	Length	Tube
3/8X24	H9.5	19	3/16"

**KFAT43-6**

Thread	Seat	Length	Tube
M10X1	H10	23	Φ5.2

**KFAT44**

Thread	Seat	Length	Tube
M10X1	H10	14.5	3/16"

**KFAT44-2**

Thread	Seat	Length	Tube
3/8X24	H10	14.5	3/16"

**KFAT44-3**

Thread	Seat	Length	Tube
M12X1.25	H13	14.5	3/16"

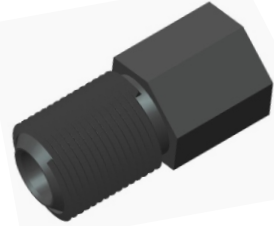
**KFAT45**

Thread	Seat	Length	Tube
7/16X24	H11	21	3/16"

**KFAT45-2**

Thread	Seat	Length	Tube
M10X1	H10	21	3/16"

**KFAT46**

Thread	Seat	Length	Tube
3/8X24	H10	17	Φ5.2

**KFAT47**

Thread	Seat	Length	Tube
M14X1	H14	17.5	5/16"



**KFAT48**

Thread	Seat	Length	Tube
9/16X20	H14	19.2	3/16"

**KFAT49**

Thread	Seat	Length	Tube
5/8X18	H16	16.7	5/16"

**KFAT49-2**

Thread	Seat	Length	Tube
5/8X18	H16	16.7	3/8"

**KFAT50**

Thread	Seat	Length	Tube
3/8X24	H14	14.5	3/16"

**KFAT51**

Thread	Seat	Length	Tube
M16X1.5	H16	19	3/8"

**KFAT52**

Thread	Seat	Length	Tube
1/2X20	1/2	31.7	3/8"

**KFAT52-2**

Thread	Seat	Length	Tube
3/8X24	H11	32	3/16"

**KFAT53**

Thread	Seat	Length	Tube
1/2X20	1/2	26	Φ8

**KFAT54**

Thread	Seat	Length	Tube
3/8X19NPSM	H18	18	Φ13

**KFAT55**

Thread	Seat	Length	Tube
7/16X24	1/4	13.5	3/16"

**KFAT56**

Thread	Seat	Length	Tube
M8	H8	19.5	1/4"

**KFAT56-2**

Thread	Seat	Length	Tube
M8	H8	20	1/4"

**KFAT57**

Thread	Seat	Length	Tube
M7X1	H8.5	10	1/8"

**KFAT57-2**

Thread	Seat	Length	Tube
M7X1	H8	10	1/8"

**KFAT58**

Thread	Seat	Length	Tube
9/16X24	H14	18	3/8"

**KFAT59**

Thread	Seat	Length	Tube
1/2X24	H13	13	5/16"

**KFAT59-2**

Thread	Seat	Length	Tube
1/2X20	H13	13	5/16"

**KFAT59-3**

Thread	Seat	Length	Tube
1/2X24	H14	18	5/16"

**KFAT59-4**

Thread	Seat	Length	Tube
1/2X20	H13	13	5/16"

**KFAT59-5**

Thread	Seat	Length	Tube
1/2X20	H13	15.5	3/16"

**KFAT60**

Thread	Seat	Length	Tube
1/4X19NPSM	H16	17.4	Φ9

**KFAT60-2**

Thread	Seat	Length	Tube
G1/4	H16	16.3	Φ9

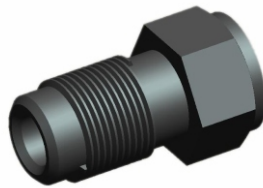
**KFAT61**

Thread	Seat	Length	Tube
7/16X24	H13	22	3/16"

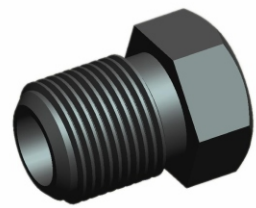
**KFAT62**

Thread	Seat	Length	Tube
M10X1.25	H10	14.2	3/16"

**KFAT63**

Thread	Seat	Length	Tube
M9X1.25	H10	20	3/16"

**KFAT64**

Thread	Seat	Length	Tube
5/8-18	H15.8	27	Φ9.8

**KFAT65**

Thread	Seat	Length	Tube
M10X1	H11	16	3/16"

**KFAT66**

Thread	Seat	Length	Tube
M14X1.5	H14	26	Φ8.3

**KFAT66-2**

Thread	Seat	Length	Tube
M14X1.5	H14	21	Φ8.3

**KFAT67**

Thread	Seat	Length	Tube
M12X1	H13	18	3/16"

**KFAT68**

Thread	Seat	Length	Tube
M10X1	H11	17	3/16"

**KFAT69**

Thread	Seat	Length	Tube
M11X1.5	H12	17.5	Φ5

**KFAT70**

Thread	Seat	Length	Tube
M10X1	H14.2	43	3/16"

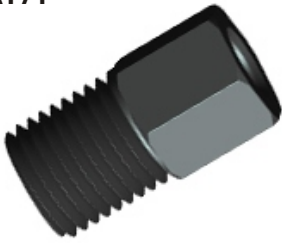
**KFAT71**

Thread	Seat	Length	Tube
3/8X24	H9.5	19	Φ5.1

**KFAT72**

Thread	Seat	Length	Tube
3/8X24	H9.5	21.5	Φ5

**KFAT73**

Thread	Seat	Length	Tube
M10X1	H11	20	Φ6.2

**KFAT74**

Thread	Seat	Length	Tube
3/8X24	H11	18	3/16"

**KFAT75**

Thread	Seat	Length	Tube
M10X1	H11	17	Φ5

**KFAT76**

Thread	Seat	Length	Tube
M10X1	H11	17	Φ5

**KFAT77**

Thread	Seat	Length	Tube
3/8X24	H11	18	3/16"

**KFAT78**

Thread	Seat	Length	Tube
M10X1	H11	17	Φ5

**KFAT79**

Thread	Seat	Length	Tube
M10X1	H11	17	Φ5

**KFAT80**

Thread	Seat	Length	Tube
3/8X24	H11	18	3/16"

**KFAT81**

Thread	Seat	Length	Tube
M10X1	H11	17	Φ5

**KFAT82**

Thread	Seat	Length	Tube
M12X1	H13	20.6	

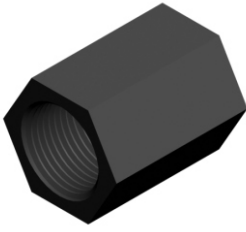
**KFAU01**

Thread	Seat	Length
3/8X24	H12	16

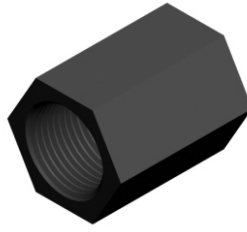
**KFAU01-2**

Thread	Seat	Length
3/8X24	H11	16

**KFAU01-3**

Thread	Seat	Length
3/8X24	H11	14.6

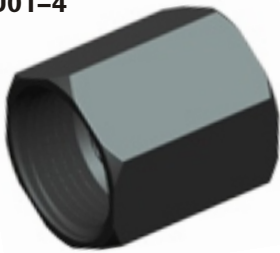
**KFAU01-4**

Thread	Seat	Length
1/2X24	H16	18

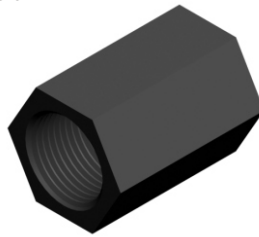
**KFAU02**

Thread	Seat	Length
3/8X24	H13	18

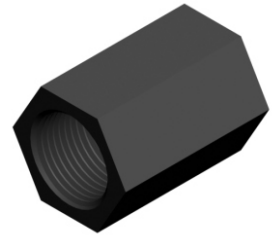
**KFAU02-2**

Thread	Seat	Length
M10X1	H13	22

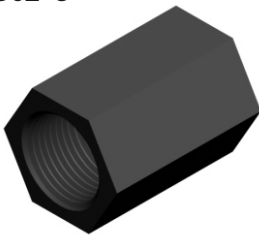
**KFAU02-3**

Thread	Seat	Length
M10X1	H13	25

**KFAU02-4**

Thread	Seat	Length
M10X1	H14	23

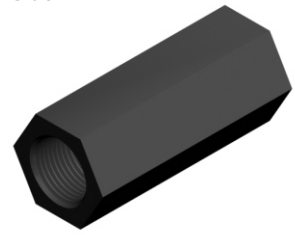
**KFAU03**

Thread	Seat	Length
3/8X24	H13	32

**KFAU04**

Thread	Seat	Length
3/8X24	H13	26

**KFAU04-2**

Thread	Seat	Length
3/8X24	H14.5	29.2

**KFAU05**

Thread	Seat	Length
M10X1	H13	26

**KFAU05-2**

Thread	Seat	Length
M10X1	H13	25

**KFAU05-3**

Thread	Seat	Length
M10X1	H14	29

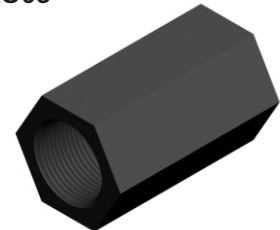
**KFAU06**

Thread	Seat	Length
M12X1.5	H16	28

**KFAU07**

Thread	Seat	Length
M10X1	H13	26

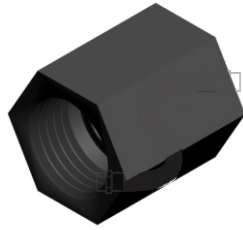
**KFAU08**

Thread	Seat	Length
7/16X24	H14	16

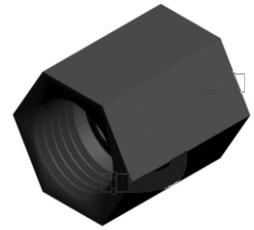
**KFAU08-2**

Thread	Seat	Length
7/16X24	H13	16

**KFAU08-3**

Thread	Seat	Length
5/8X18	H18	20

**KFAU09**

Thread	Seat	Length
M10X1	H14	24

**KFAU09-2**

Thread	Seat	Length
3/8X24	H14	25

**KFAU09-3**

Thread	Seat	Length
1/2X20	H16	26

**KFAU09-4**

Thread	Seat	Length
M14X1.5	H19	34.8

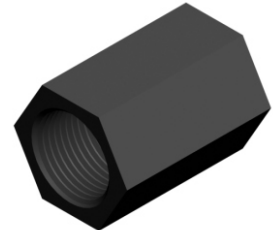
**KFAU10**

Thread	Seat	Length
7/16X 20-- 7/16X 20	H14	29.7

**KFAU11**

Thread	Seat	Length
M10X1	H13	28

**KFAU12**

Thread	Seat	Length
3/8X 24	H11	15

**KFAU12-2**

Thread	Seat	Length
3/8X 24	H11	15.2

**KFAU13**

Thread	Seat	Length
3/8X 24	H14	33.2

**KFAU14**

Thread	Seat	Length
M10X1	H13	23.2

**KFAU15**

Thread	Seat	Length
7/16X 20	H14	16

**KFAU16**



Thread	Seat	Length
3/8X24	H12.8	28.6

**KFAU17**



Thread	Seat	Length
M12X1	H16	25

**KFAU18**

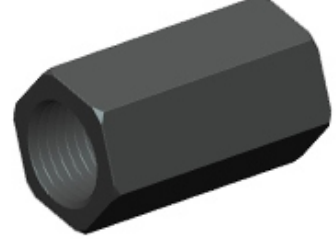

Thread	Seat	Length
M10X1	H13	24

**KFAU19**

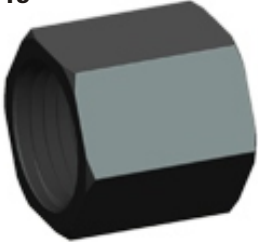

Thread	Seat	Length
1/2X20	H16	16

**KFAU20**

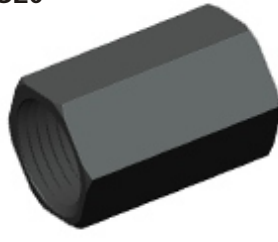

Thread	Seat	Length
M16X1.5	H19	30.7

**KFAU21**



Thread	Seat	Length
M14X1.5	H19	30.5

**KFBB01**

Thread	Seat	Length
M10X1	H14	34

**KFBB02**

Thread	Seat	Length
7/16X20	H16	34

**KFBB02-2**

Thread	Seat	Length
M10X1	H16	34

**KFBB02-3**

Thread	Seat	Length
7/16X20	H16	32

**KFBB02-4**

Thread	Seat	Length
7/16X20	H16	29.2

**KFBB02-5**

Thread	Seat	Length
7/16X20	H16	33.7

**KFBB03**

Thread	Seat	Length
3/8X24	H14	28

**KFBB03-2**

Thread	Seat	Length
3/8X24	H14	38

**KFBB04**

Thread	Seat	Length
3/8X24	H16	28

**KFBB04-2**

Thread	Seat	Length
3/8X24	H16	28

**KFBB05**

Thread	Seat	Length
M10X1	H14	27

**KFBB06**

Thread	Seat	Length
M10X1.25	H12	29

**KFBB07**

Thread	Seat	Length
M10X1	H12	29

**KFBB08**

Thread	Seat	Length
M10X1.25	H14	33

**KFBB09**

Thread	Seat	Length
3/8X24	H12	31

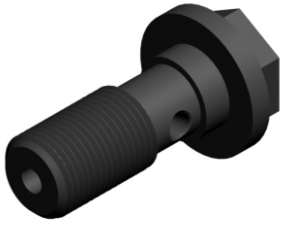
**KFBB10**

Thread	Seat	Length
M10X1	H12	31.5

**KFBB10-2**

Thread	Seat	Length
M12X1.5	H12	31.5

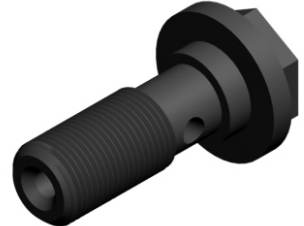
**KFBB11**

Thread	Seat	Length
3/8X24	H12	31.5

**KFBB12**

Thread	Seat	Length
M10X1	H12	28

**KFBB13**

Thread	Seat	Length
M8X1	H12	12

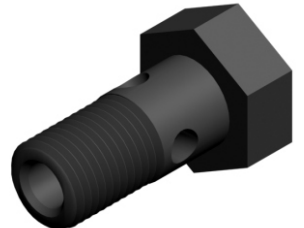
**KFBB13-2**

Thread	Seat	Length
M8X1.25	H12	12

**KFBB14**

Thread	Seat	Length
M10X1	H14	25

**KFBB15**

Thread	Seat	Length
M10X1	H17	33

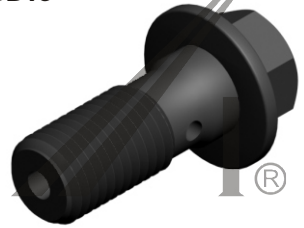
**KFBB16**

Thread	Seat	Length
M10X1.5	H11	32

**KFBB17**

Thread	Seat	Length
3/8X24	H14	29

**KFBB18**

Thread	Seat	Length
7/16X20	H19	36

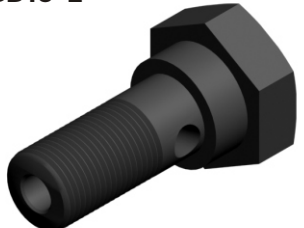
**KFBB18-2**

Thread	Seat	Length
7/16X24	H19	36

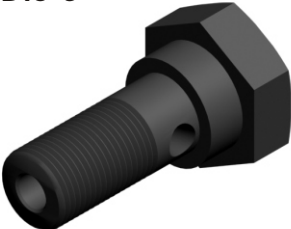
**KFBB18-3**

Thread	Seat	Length
M12X1.25	H19	36

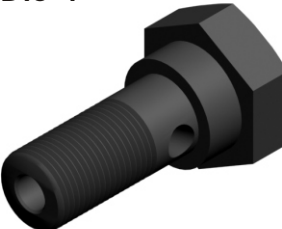
**KFBB18-4**

Thread	Seat	Length
M10X1.5	H14	24.5

**KFBB19**

Thread	Seat	Length
M10X1	H14	30



**KFBB19-2**

Thread	Seat	Length
3/8X24	H14	25

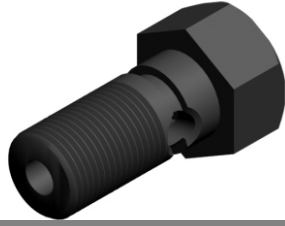
**KFBB20**

Thread	Seat	Length
M10X1	H14	28

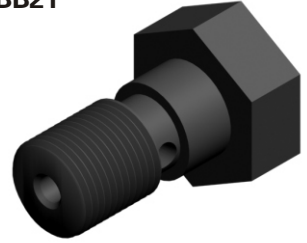
**KFBB21**

Thread	Seat	Length
7/16X20	H17	28

**KFBB22**

Thread	Seat	Length
M10X1.25	H14	27

**KFBB22-2**

Thread	Seat	Length
M10X1.25	H14	24

**KFBB23**

Thread	Seat	Length
7/16X20	H11	32

**KFBB24**

Thread	Seat	Length
M10X1.5	H11	32

**KFBB24-2**

Thread	Seat	Length
3/8X24	H14	31.5

**KFBB24-3**

Thread	Seat	Length
M10X1	H11	33

**KFBB24-4**

Thread	Seat	Length
M10X1	H11	37

**KFBB25**

Thread	Seat	Length
3/8X24	H12	31

**KFBB26**

Thread	Seat	Length
M10X1.5	H11	28

**KFBB26-2**

Thread	Seat	Length
M10X1.5	H11	28

**KFBB26-3**

Thread	Seat	Length
M10X1.5	H11	26

**KFBB27**

Thread	Seat	Length
7/16X24	H14	38

**KFBB27-2**

Thread	Seat	Length
7/16X24	H11	27

**KFBB28**

Thread	Seat	Length
M10X1	H14	37

**KFBB29**

Thread	Seat	Length
M10X1	H12	39

**KFBB30**

Thread	Seat	Length
M10X1	H14	30.5

**KFBB31**

Thread	Seat	Length
M12X1.5	H17	26.5

**KFBB31-2**

Thread	Seat	Length
M14X1.5	H22	32

**KFBB32**

Thread	Seat	Length
M6X1	H8	33

**KFBB33**

Thread	Seat	Length
M10X1.25	H13	33

**KFBB33-2**

Thread	Seat	Length
M10X1	H14	33

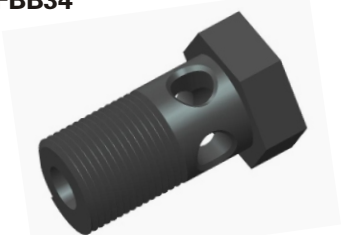
**KFBB34**

Thread	Seat	Length
M22X1.5	H27	46

**KFBB35**

Thread	Seat	Length
M10X1	H11	33.5

**KFBB36**

Thread	Seat	Length
M14X1.5	H19	35

**KFBB36-2**

Thread	Seat	Length
M14X1.5	H19	35

**KFBB37**

Thread	Seat	Length
M12X1	H13	28.8

**KFBB38**

Thread	Seat	Length
M10X1	H13	21

**KFBB39**

Thread	Seat	Length
M12X1	H13	28.8

**KFBB40**

Thread	Seat	Length
M10X1	H11	36.6

**KFBB41**

Thread	Seat	Length
M8X1	H17	70

**KFBB42**

Thread	Seat	Length
M12X1--M10X1	H17	32.5

**KFBB43**

Thread	Seat	Length
M10X1	H17	24.5

**KFBB44**

Thread	Seat	Length
1/2X2 0-1/8X 27NPT	H19	36

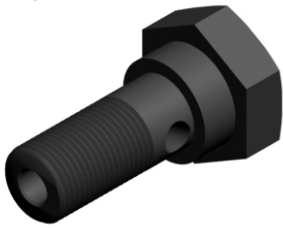
**KFBB45**

Thread	Seat	Length
7/16X24	H16	28

**KFBB46**

Thread	Seat	Length
1/2X20	H19	36

**KFBB47**

Thread	Seat	Length
7/16X24	H11	36

**KFBB48**

Thread	Seat	Length
7/16X24	H16	29

**KFBB49**

Thread	Seat	Length
M10X1.5	H16	29

**KFBB50**

Thread	Seat	Length
M10X1	H14	24

**KFBB50-2**

Thread	Seat	Length
M10X1.25	H14	24

**KFBB51**

Thread	Seat	Length
M10X1.5	H14	24.5

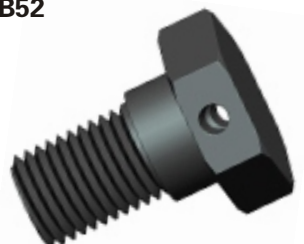
**KFBB52**

Thread	Seat	Length
7/16X20	H19	27

**KFBB53**

Thread	Seat	Length
7/16X20	H16	34

**KFBB54**

Thread	Seat	Length
M10X1	H14	23.5

**KFBB55**

Thread	Seat	Length
M10X1	H11	37

**KFBB56**

Thread	Seat	Length
7/16X20	H15	26.5

**KFBB57**

Thread	Seat	Length
M10X1.5	H14	25

**KFBB58**

Thread	Seat	Length
M10X1.25	H14	28.1

**KFBB59**

Thread	Seat	Length
M10X1	H15	30

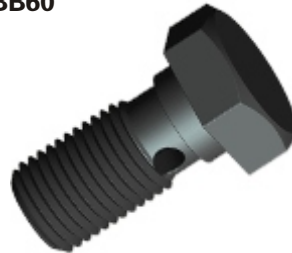
**KFBB60**

Thread	Seat	Length
3/8X24	H14	25

**KFBB61**

Thread	Seat	Length
M10X1	H14	22.5

**KFBB62**

Thread	Seat	Length
M8X1	H12	20

**KFBB63**

Thread	Seat	Length
7/16X24	H13	27

**KFBB64**

Thread	Seat	Length
M10X1--M10X1	H17	33.5

**KFBB65**

Thread	Seat	Length
1/2X20	H19	36

**KFBB66**

Thread	Seat	Length
M10X1	H14	36

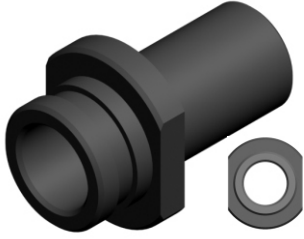
**KFC001**

Thread	Seat	Length	Seal
	Φ24	35	

**KFC001-2**

Thread	Seat	Length	Seal
	Φ20	33.5	

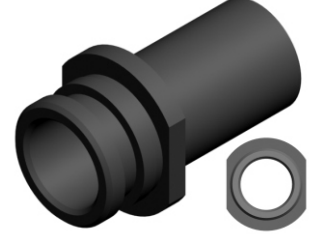
**KFC002**

Thread	Seat	Length	Seal
	Φ20	31	

**KFC002-2**

Thread	Seat	Length	Seal
	Φ23	36	

**KFC002-3**

Thread	Seat	Length	Seal
	Φ20	34	

**KFC002-4**

Thread	Seat	Length	Seal
	Φ22	31	

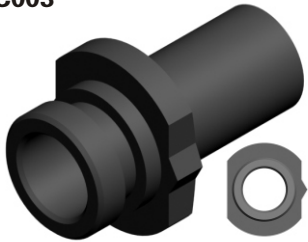
**KFC003**

Thread	Seat	Length	Seal
	Φ23	35	

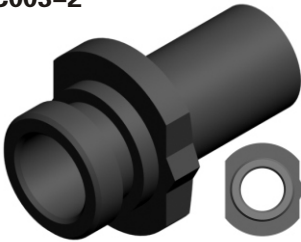
**KFC003-2**

Thread	Seat	Length	Seal
	Φ24	35	

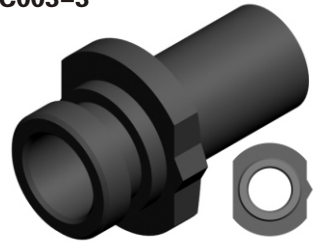
**KFC003-3**

Thread	Seat	Length	Seal
	Φ22	35	

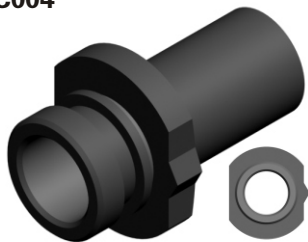
**KFC004**

Thread	Seat	Length	Seal
	Φ20	23	

**KFC005**

Thread	Seat	Length	Seal
	H17	38	

**KFC005-2**

Thread	Seat	Length	Seal
	H17	32.5	

**KFC006**

Thread	Seat	Length	Seal
	H19	34	

**KFC007**

Thread	Seat	Length	Seal
	H19	35	

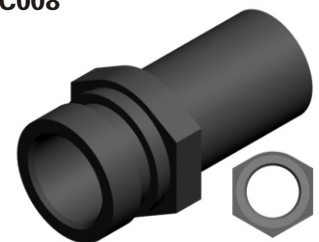
**KFC008**

Thread	Seat	Length	Seal
	H17	33	

**KFC008-2**

Thread	Seat	Length	Seal
	H19	33	

**KFC009**

Thread	Seat	Length	Seal
	Φ20	35	

**KFC009-2**

Thread	Seat	Length	Seal
	Φ20.5	31.9	

**KFC010**

Thread	Seat	Length	Seal
	Φ20	32	

**KFC011**

Thread	Seat	Length	Seal
	H17	33	

**KFC012**

Thread	Seat	Length	Seal
	H19	33	

**KFC013**

Thread	Seat	Length	Seal
	Φ20	31	

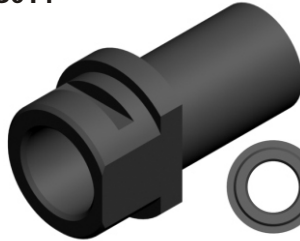
**KFC014**

Thread	Seat	Length	Seal
	Φ20	32.5	

**KFC015**

Thread	Seat	Length	Seal
	Φ23	13.5	

**KFC015-2**

Thread	Seat	Length	Seal
	Φ16	37	

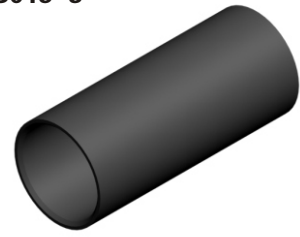
**KFC015-3**

Thread	Seat	Length	Seal
	Φ13.5	37	

**KFC016**

Thread	Seat	Length	Seal
	Φ17	47	

**KFC017**

Thread	Seat	Length	Seal
	Φ23	36.5	

**KFC018**

Thread	Seat	Length	Seal
	Φ19	39	

**KFC018-2**

Thread	Seat	Length	Seal
	Φ17	39	

**KFC019**

Thread	Seat	Length	Seal
	H16	37	

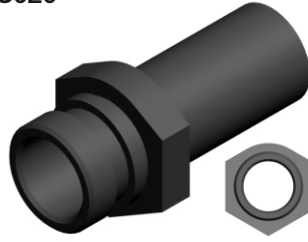
**KFC020**

Thread	Seat	Length	Seal
	H19	39	

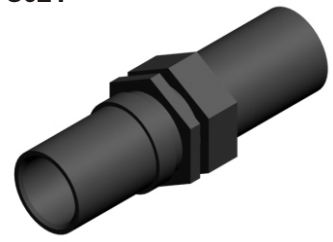
**KFC021**

Thread	Seat	Length	Seal
	H17	52	

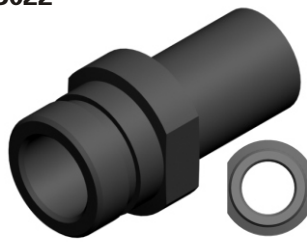
**KFC022**

Thread	Seat	Length	Seal
	Φ19	36	

**KFC022-2**

Thread	Seat	Length	Seal
	Φ20	36	

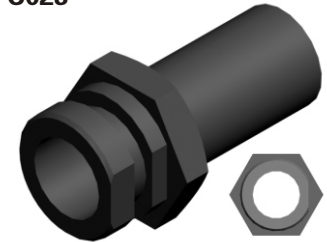
**KFC023**

Thread	Seat	Length	Seal
	H19	36.5	

**KFC024**

Thread	Seat	Length	Seal
	Φ21	37	

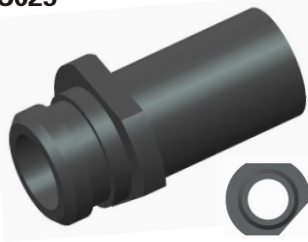
**KFC025**

Thread	Seat	Length	Seal
	Φ20	31.5	

**KFC026**

Thread	Seat	Length	Seal
	Φ19	37.5	

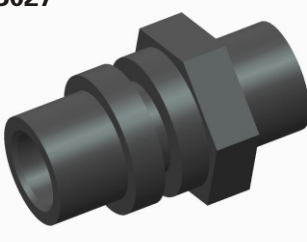
**KFC027**

Thread	Seat	Length	Seal
	H17	29.5	

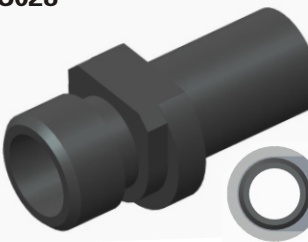
**KFC028**

Thread	Seat	Length	Seal
	Φ20.5	38	

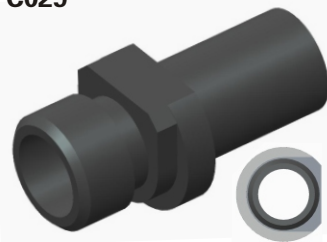
**KFC029**

Thread	Seat	Length	Seal
	Φ23	38	

**KFC030**

Thread	Seat	Length	Seal
	Φ16	45	

**KFC031**

Thread	Seat	Length	Seal
	Φ23	33.5	

**KFC032**

Thread	Seat	Length	Seal
	Φ17	25.4	

**KFC033**

Thread	Seat	Length	Seal
	Ø23	30	

**KFC034**

Thread	Seat	Length	Seal
	H17	25	

**KFC034-2**

Thread	Seat	Length	Seal
	H17	24	

**KFC035**

Thread	Seat	Length	Seal
	H17	32	

**KFC036**

Thread	Seat	Length	Seal
	H17	27	

**KFC037**

Thread	Seat	Length	Seal
	H17	27	

**KFC038**

Thread	Seat	Length	Seal
	Ø20	32.3	

**KFC039**

Thread	Seat	Length	Seal
	Ø24	35	

**KFC040**

Thread	Seat	Length	Seal
	H17	33.2	

**KFC041**

Thread	Seat	Length	Seal
	H21	36	

**KFC042**

Thread	Seat	Length	Seal
	Ø20.5	31.2	



**KFC101**



Thread | Hole | Length | Seal

**KFC101B**



Thread | Hole | Length | Seal

**KFC101-2**



Thread | Hole | Length | Seal

**KFC101-3**



Thread | Hole | Length | Seal

**KFC102**



Thread | Hole | Length | Seal

**KFC102B**



Thread | Hole | Length | Seal

**KFC103**



Thread | Hole | Length | Seal

**KFC104**



Thread | Hole | Length | Seal

**KFC104B**



Thread | Hole | Length | Seal

**KFC105-1**



Thread | Hole | Length | Seal

**KFC105-2**



Thread | Hole | Length | Seal

**KFC106**



Thread | Hole | Length | Seal

**KFC107**



Thread | Hole | Length | Seal

**KFC108**

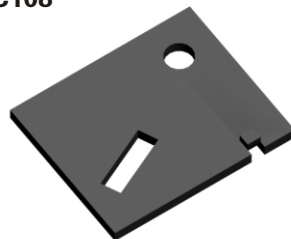

Thread | Hole | Length | Seal

**KFC109**

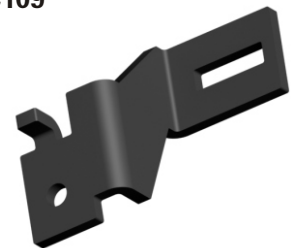

Thread | Hole | Length | Seal

**KFC109B**

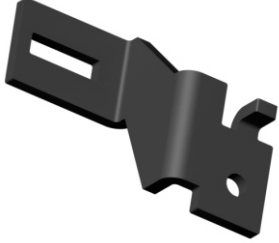

Thread | Hole | Length | Seal

**KFC110**



Thread | Hole | Length | Seal

**KFC111**



Thread | Hole | Length | Seal

**KFC112**



Thread | Hole | Length | Seal

**KFC113**



Thread | Hole | Length | Seal

**KFC114**



Thread | Hole | Length | Seal

**KFC115**



Thread | Hole | Length | Seal

**KFC116**



Thread | Hole | Length | Seal

**KFC117**



Thread | Hole | Length | Seal

**KFC118**

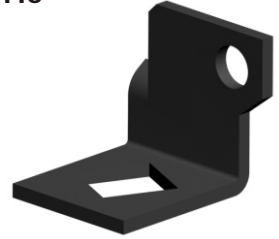

Thread | Hole | Length | Seal

**KFC118B**



Thread | Hole | Length | Seal

**KFC119**

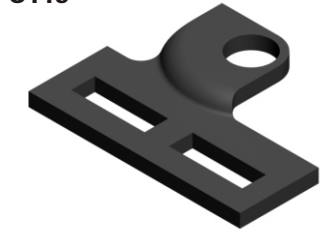

Thread | Hole | Length | Seal

**KFC120**



Thread | Hole | Length | Seal

**KFC120B**

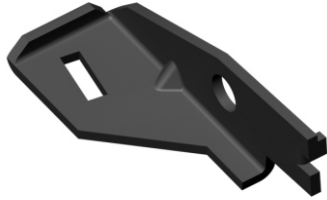

Thread | Hole | Length | Seal

**KFC121**



Thread | Hole | Length | Seal

**KFC121B**



Thread | Hole | Length | Seal

**KFC122**



Thread | Hole | Length | Seal

**KFC122B**



Thread | Hole | Length | Seal

**KFC123**



Thread | Hole | Length | Seal

**KFC124**



Thread | Hole | Length | Seal

**KFC124B**



Thread | Hole | Length | Seal

**KFC125**



Thread | Hole | Length | Seal

**KFC125B**



Thread | Hole | Length | Seal

**KFC126**



Thread | Hole | Length | Seal

**KFC126B**



Thread | Hole | Length | Seal

**KFC127**



Thread | Hole | Length | Seal

**KFC127B**



Thread | Hole | Length | Seal

**KFC127-2**



Thread | Hole | Length | Seal

**KFC128**



Thread | Hole | Length | Seal

**KFC129**



Thread | Hole | Length | Seal

**KFC130**



Thread | Hole | Length | Seal

**KFC131**

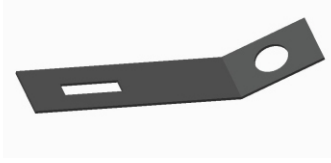

Thread | Hole | Length | Seal

**KFC132**



Thread | Hole | Length | Seal

**KFC133**



Thread | Hole | Length | Seal

**KFC133B**



Thread | Hole | Length | Seal

**KFC134**



Thread | Hole | Length | Seal

**KFC135**



Thread | Hole | Length | Seal

**KFC135B**



Thread | Hole | Length | Seal

**KFC136**



Thread | Hole | Length | Seal

**KFC136B**



Thread | Hole | Length | Seal

**KFC137**



Thread | Hole | Length | Seal

**KFC137-2**



Thread | Hole | Length | Seal

**KFC138**



Thread | Hole | Length | Seal

**KFC139**



Thread | Hole | Length | Seal

**KFC139-2**



Thread | Hole | Length | Seal

**KFC140**



Thread | Hole | Length | Seal

**KFC140B**



Thread | Hole | Length | Seal

**KFC141**



Thread | Hole | Length | Seal

**KFC141B**



Thread | Hole | Length | Seal

**KFC142**



Thread | Hole | Length | Seal

**KFC143**



Thread | Hole | Length | Seal

**KFC144**



Thread | Hole | Length | Seal

**KFC144B**



Thread | Hole | Length | Seal

**KFC145**



Thread | Hole | Length | Seal

**KFC146**



Thread | Hole | Length | Seal

**KFC147**



Thread | Hole | Length | Seal

**KFC148**



Thread | Hole | Length | Seal

**KFC149**



Thread | Hole | Length | Seal

**KFC149B**



Thread | Hole | Length | Seal

**KFC150**



Thread | Hole | Length | Seal

**KFC151**



Thread | Hole | Length | Seal

**KFC151B**



Thread | Hole | Length | Seal

**KFC152**



Thread | Hole | Length | Seal

**KFC153**

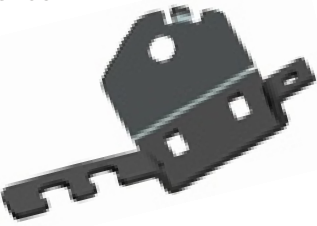

Thread | Hole | Length | Seal

**KFC154**



Thread | Hole | Length | Seal

**KFC155**



Thread | Hole | Length | Seal

**KFC156**

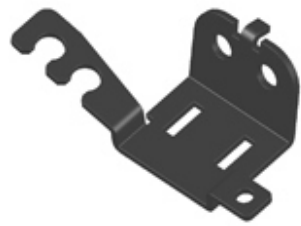

Thread | Hole | Length | Seal

**KFC157**



Thread | Hole | Length | Seal

**KFC157B**



Thread | Hole | Length | Seal

**KFC158**



Thread | Hole | Length | Seal

**KFC159**



Thread | Hole | Length | Seal

**KFC160**

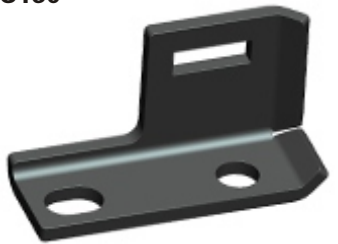

Thread | Hole | Length | Seal

**KFC160B**



Thread | Hole | Length | Seal

**KFC161**

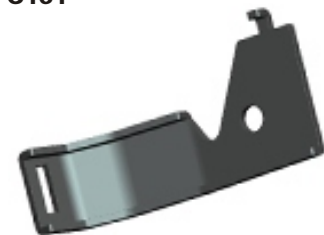

Thread | Hole | Length | Seal

**KFC161B**



Thread | Hole | Length | Seal

**KFC162**



Thread	Hole	Length	Seal
--------	------	--------	------

**KFC162B**



Thread	Hole	Length	Seal
--------	------	--------	------

**KFC201**



Thread | Hole | Length | Seal

**KFC202**



Thread | Hole | Length | Seal

**KFC203**



Thread | Hole | Length | Seal

**KFC204**

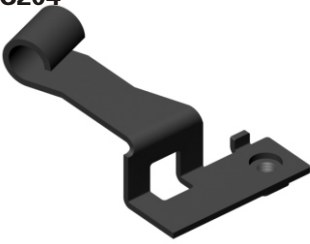

Thread | Hole | Length | Seal

**KFC204B**

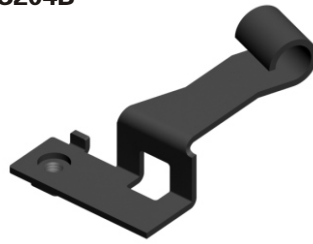

Thread | Hole | Length | Seal

**KFC205**



Thread | Hole | Length | Seal

**KFC206**



Thread | Hole | Length | Seal

**KFC207**

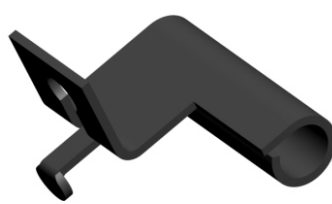

Thread | Hole | Length | Seal

**KFC208**



Thread | Hole | Length | Seal

**KFC208B**



Thread | Hole | Length | Seal

**KFC209**



Thread | Hole | Length | Seal

**KFC209B**



Thread | Hole | Length | Seal

**KFC210**

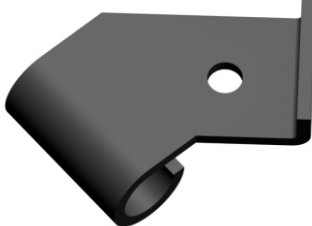

Thread | Hole | Length | Seal

**KFC210B**

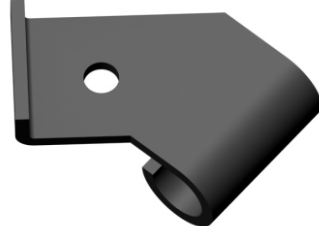

Thread | Hole | Length | Seal

**KFC211**



Thread | Hole | Length | Seal



**KFC211B**

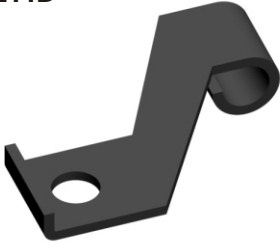

Thread | Hole | Length | Seal

**KFC212**

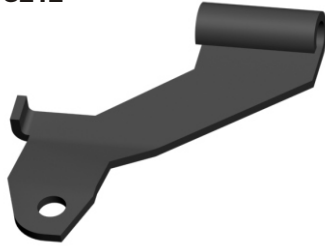

Thread | Hole | Length | Seal

**KFC212B**

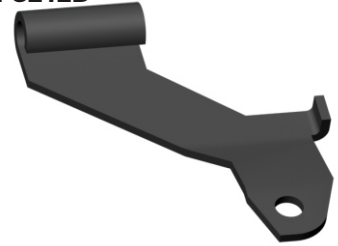

Thread | Hole | Length | Seal

**KFC213**

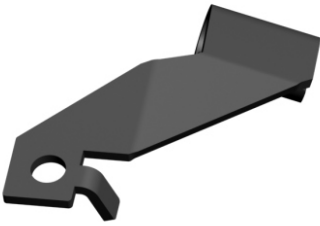

Thread | Hole | Length | Seal

**KFC213B**

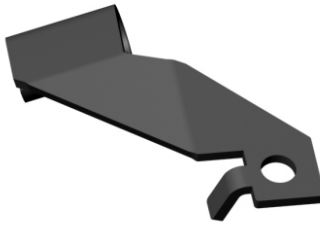

Thread | Hole | Length | Seal

**KFC214**



Thread | Hole | Length | Seal

**KFC214B**



Thread | Hole | Length | Seal

**KFC215**

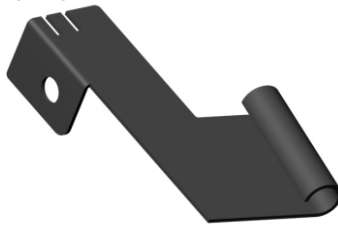

Thread | Hole | Length | Seal

**KFC215B**

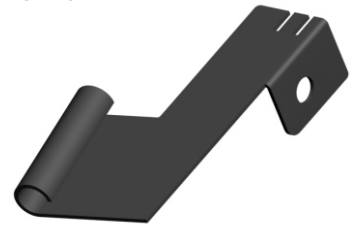

Thread | Hole | Length | Seal

**KFC216**



Thread | Hole | Length | Seal

**KFC216B**

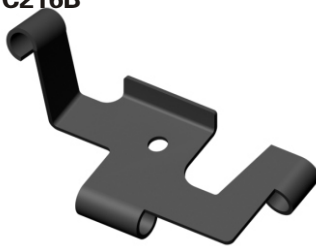

Thread | Hole | Length | Seal

**KFC217**

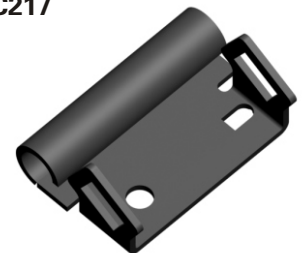

Thread | Hole | Length | Seal

**KFC218**



Thread | Hole | Length | Seal

**KFC218B**



Thread | Hole | Length | Seal

**KFC219**



Thread | Hole | Length | Seal

**KFC219B**

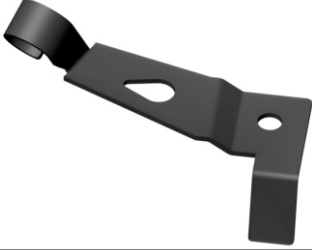

Thread | Hole | Length | Seal

**KFC220**



Thread | Hole | Length | Seal

**KFC220B**



Thread | Hole | Length | Seal

**KFC221**

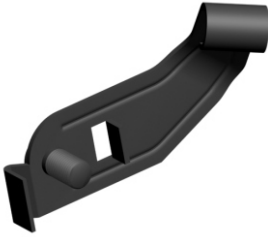

Thread | Hole | Length | Seal

**KFC221B**



Thread | Hole | Length | Seal

**KFC222**



Thread | Hole | Length | Seal

**KFC223**



Thread | Hole | Length | Seal

**KFC223B**



Thread | Hole | Length | Seal

**KFC224**



Thread | Hole | Length | Seal

**KFC224B**



Thread | Hole | Length | Seal

**KFC225**



Thread | Hole | Length | Seal

**KFC225B**



Thread | Hole | Length | Seal

**KFC226**



Thread | Hole | Length | Seal

**KFC226B**



Thread | Hole | Length | Seal

**KFC227**

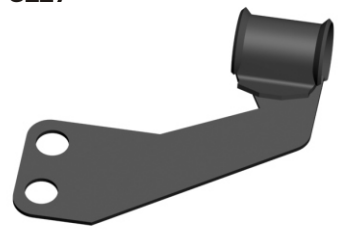

Thread | Hole | Length | Seal

**KFC228**



Thread | Hole | Length | Seal

**KFC228B**



Thread | Hole | Length | Seal

**KFC229**



Thread | Hole | Length | Seal

**KFC230**

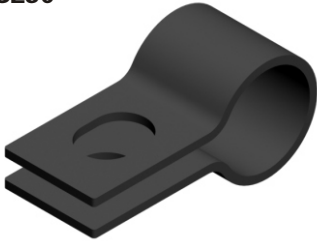

Thread | Hole | Length | Seal

**KFC231**



Thread | Hole | Length | Seal

**KFC231B**



Thread | Hole | Length | Seal

**KFC232**



Thread | Hole | Length | Seal

**KFC232B**

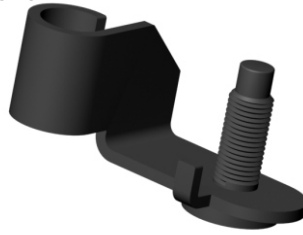

Thread | Hole | Length | Seal

**KFC233**



Thread | Hole | Length | Seal

**KFC233B**



Thread | Hole | Length | Seal

**KFC234**

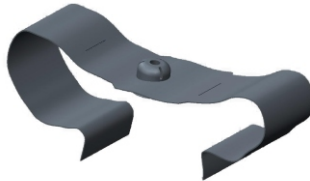

Thread | Hole | Length | Seal

**KFC235**

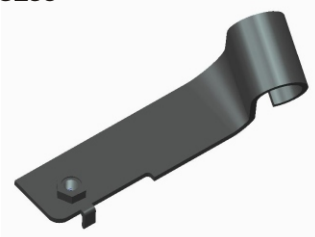

Thread | Hole | Length | Seal

**KFC235B**



Thread | Hole | Length | Seal

**KFC236**



Thread | Hole | Length | Seal

**KFC236B**



Thread | Hole | Length | Seal

**KFC237**



Thread | Hole | Length | Seal

**KFC238**



Thread | Hole | Length | Seal

**KFC238B**



Thread | Hole | Length | Seal

**KFC239**

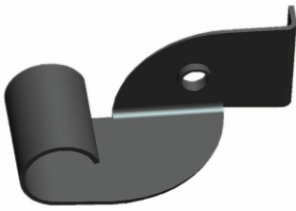

Thread | Hole | Length | Seal

**KFC239B**

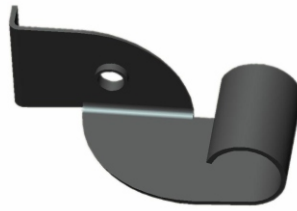

Thread | Hole | Length | Seal

**KFC240**

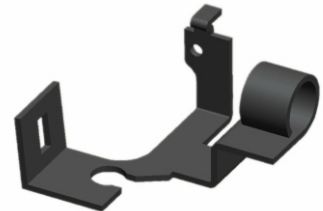

Thread | Hole | Length | Seal

**KFC240B**

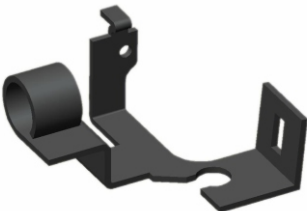

Thread | Hole | Length | Seal

**KFC241**

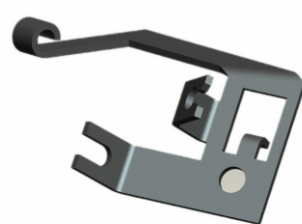

Thread | Hole | Length | Seal

**KFC241B**

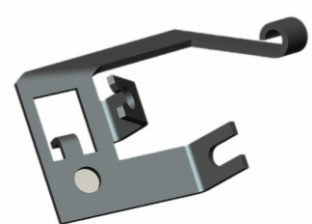

Thread | Hole | Length | Seal

**KFC242**



Thread | Hole | Length | Seal

**KFC243**



Thread | Hole | Length | Seal

**KFC244**



Thread | Hole | Length | Seal

**KFC245**



Thread | Hole | Length | Seal

**KFC245B**



Thread | Hole | Length | Seal

**KFC246**



Thread | Hole | Length | Seal

**KFC246B**



Thread | Hole | Length | Seal

**KFC247**



Thread | Hole | Length | Seal

**KFC247B**



Thread | Hole | Length | Seal

**KFC248**



Thread | Hole | Length | Seal

**KFC248B**



Thread | Hole | Length | Seal

**KFC249**



Thread | Hole | Length | Seal

**KFC250**



Thread | Hole | Length | Seal

**KFC250B**



Thread | Hole | Length | Seal

**KFC251**



Thread | Hole | Length | Seal

**KFC252**



Thread | Hole | Length | Seal

**KFC253**



Thread | Hole | Length | Seal

**KFC253B**

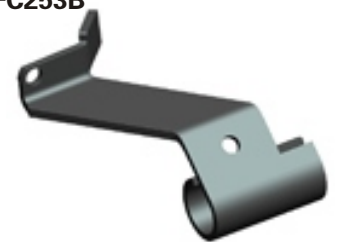

Thread | Hole | Length | Seal

**KFC254**

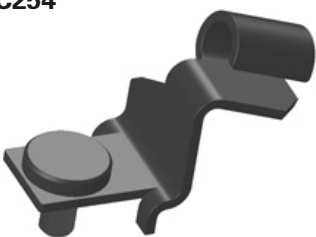

Thread | Hole | Length | Seal

**KFC255**



Thread | Hole | Length | Seal

**KFC256**



Thread | Hole | Length | Seal

**KFC256B**



Thread | Hole | Length | Seal

**KFC257**



Thread | Hole | Length | Seal

**KFC257B**



Thread | Hole | Length | Seal

**KFC258**



Thread | Hole | Length | Seal

**KFC259**



Thread | Hole | Length | Seal

**KFC259B**



Thread | Hole | Length | Seal

**KFC260**



Thread | Hole | Length | Seal

**KFC260B**



Thread | Hole | Length | Seal

**KFC261**



Thread | Hole | Length | Seal

**KFC262**



Thread | Hole | Length | Seal

**KFC262B**



Thread | Hole | Length | Seal

**KFC263**



Thread | Hole | Length | Seal

**KFC263B**



Thread | Hole | Length | Seal

**KFC264**



Thread | Hole | Length | Seal

**KFC265**



Thread | Hole | Length | Seal

**KFC265B**



Thread | Hole | Length | Seal

**KFC266**

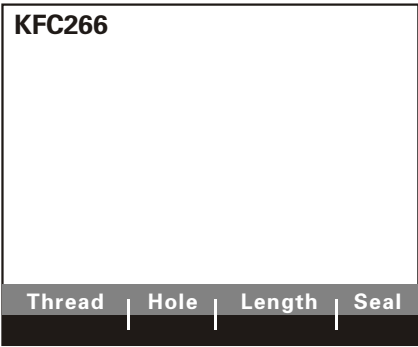

Thread | Hole | Length | Seal

**KFC267**



Thread | Hole | Length | Seal

**KFC268**



Thread | Hole | Length | Seal

**KFC268B**

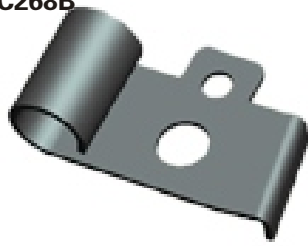

Thread | Hole | Length | Seal

**KFC269**



Thread | Hole | Length | Seal

**KFC270**



Thread | Hole | Length | Seal

**KFC270B**



Thread | Hole | Length | Seal

**KFC301**



Thread | Hole | Length | Seal

**KFC301B**



Thread | Hole | Length | Seal

**KFC302**



Thread | Hole | Length | Seal

**KFC302B**



Thread | Hole | Length | Seal

**KFC303**

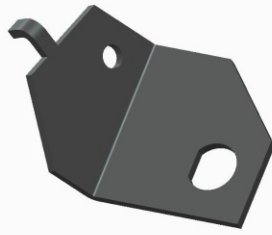

Thread | Hole | Length | Seal

**KFC303B**

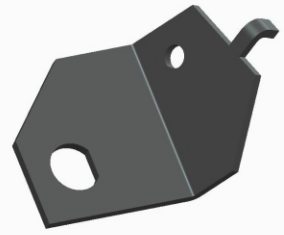

Thread | Hole | Length | Seal

**KFC304**



Thread | Hole | Length | Seal

**KFC304B**



Thread | Hole | Length | Seal

**KFC305**



Thread | Hole | Length | Seal

**KFC306**



Thread | Hole | Length | Seal

**KFC306B**



Thread | Hole | Length | Seal

**KFC307**



Thread | Hole | Length | Seal

**KFC307B**

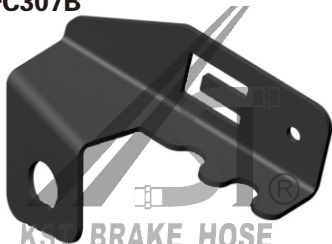

Thread | Hole | Length | Seal

**KFC308**



Thread | Hole | Length | Seal

**KFC308B**

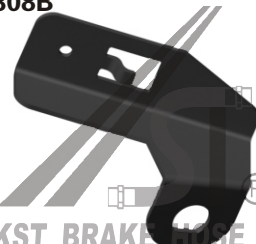

Thread | Hole | Length | Seal



**KFC309**



Thread | Hole | Length | Seal

**KFC309B**



Thread | Hole | Length | Seal

**KFC310**



Thread | Hole | Length | Seal

**KFC310B**



Thread | Hole | Length | Seal

**KFC311**

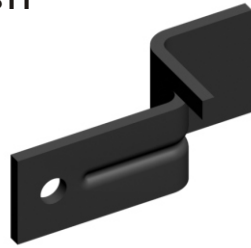

Thread | Hole | Length | Seal

**KFC312**



Thread | Hole | Length | Seal

**KFC313**

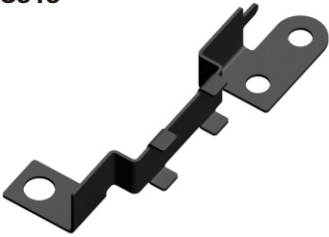

Thread | Hole | Length | Seal

**KFC313B**

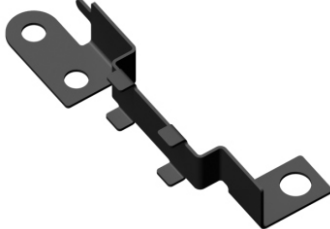

Thread | Hole | Length | Seal

**KFC314**



Thread | Hole | Length | Seal

**KFC314B**



Thread | Hole | Length | Seal

**KFC314-2**



Thread | Hole | Length | Seal

**KFC314-2B**



Thread | Hole | Length | Seal

**KFC314-3**



Thread | Hole | Length | Seal

**KFC314-3B**



Thread | Hole | Length | Seal

**KFC314-4**



Thread | Hole | Length | Seal

**KFC314-4B**



Thread | Hole | Length | Seal

**KFC314-5**



Thread | Hole | Length | Seal

**KFC314-5B**



Thread | Hole | Length | Seal

**KFC315**



Thread | Hole | Length | Seal

**KFC316**

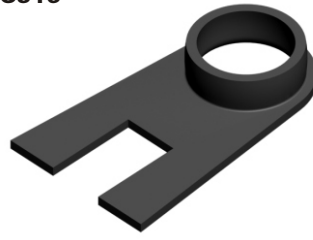

Thread | Hole | Length | Seal

**KFC317**

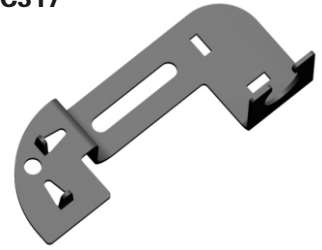

Thread | Hole | Length | Seal

**KFC318**



Thread | Hole | Length | Seal

**KFC319**

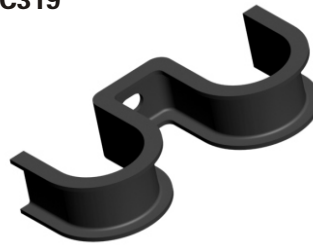

Thread | Hole | Length | Seal

**KFC320**

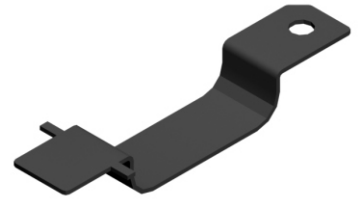

Thread | Hole | Length | Seal

**KFC321**

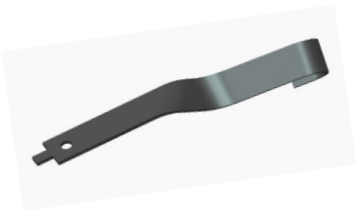

Thread | Hole | Length | Seal

**KFC322-1**



Thread | Hole | Length | Seal

**KFC322-2**



Thread | Hole | Length | Seal

**KFC323**



Thread | Hole | Length | Seal

**KFC324**



Thread | Hole | Length | Seal

**KFC324B**



Thread | Hole | Length | Seal

KFC325



Thread | Hole | Length | Seal

KFC326



Thread | Hole | Length | Seal

KFC327

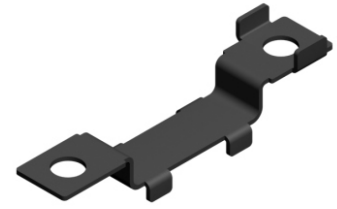

Thread | Hole | Length | Seal

KFC328



Thread | Hole | Length | Seal

KFC329



Thread | Hole | Length | Seal

KFC330

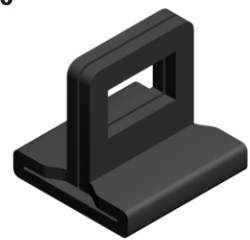

Thread | Hole | Length | Seal

KFC331



Thread | Hole | Length | Seal

KFC332



Thread | Hole | Length | Seal

KFC333

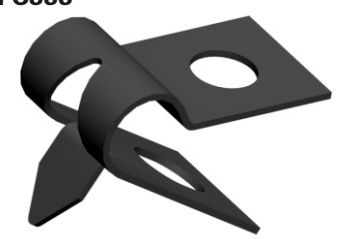

Thread | Hole | Length | Seal

KFC333-2

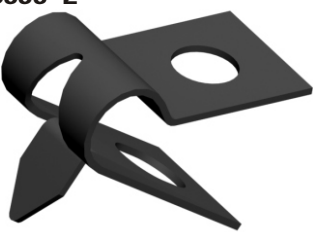

Thread | Hole | Length | Seal

KFC334



Thread | Hole | Length | Seal

KFC335



Thread | Hole | Length | Seal

KFC336



Thread | Hole | Length | Seal

KFC337



Thread | Hole | Length | Seal

KFC337B



Thread | Hole | Length | Seal

**KFC338**



Thread | Hole | Length | Seal

**KFC338B**



Thread | Hole | Length | Seal

**KFC339**



Thread | Hole | Length | Seal

**KFC340**



Thread | Hole | Length | Seal

**KFC341**



Thread | Hole | Length | Seal

**KFC342**



Thread | Hole | Length | Seal

**KFC342B**

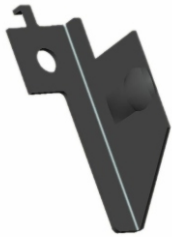

Thread | Hole | Length | Seal

**KFC343**



Thread | Hole | Length | Seal

**KFC343B**



Thread | Hole | Length | Seal

**KFC344**



Thread | Hole | Length | Seal

**KFC344B**



Thread | Hole | Length | Seal

**KFC345**



Thread | Hole | Length | Seal

**KFC345B**



Thread | Hole | Length | Seal

**KFC346**



Thread | Hole | Length | Seal

**KFC346B**



Thread | Hole | Length | Seal

**KFC347**



Thread | Hole | Length | Seal

**KFC348**



Thread | Hole | Length | Seal

**KFC349**



Thread | Hole | Length | Seal

**KFC350**



Thread | Hole | Length | Seal

**KFC350B**



Thread | Hole | Length | Seal

**KFC351**



Thread | Hole | Length | Seal

**KFC351-2**



Thread | Hole | Length | Seal

**KFC352**



Thread | Hole | Length | Seal

**KFC352**



Thread | Hole | Length | Seal

**KFC353**

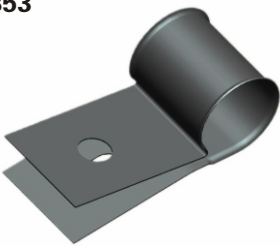

Thread | Hole | Length | Seal

**KFC354**



Thread | Hole | Length | Seal

**KFC354-2**



Thread | Hole | Length | Seal

**KFC355**



Thread | Hole | Length | Seal

**KFC356**



Thread | Hole | Length | Seal

**KFC357**

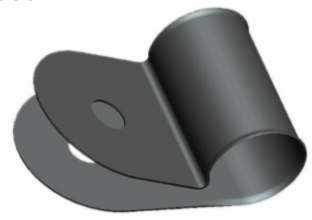

Thread | Hole | Length | Seal

**KFC358**



Thread | Hole | Length | Seal

**KFC358-2**



Thread | Hole | Length | Seal

**KFC359**



Thread | Hole | Length | Seal

**KFC360**



Thread | Hole | Length | Seal

**KFC361**



Thread | Hole | Length | Seal

**KFC362**



Thread | Hole | Length | Seal

**KFC363**

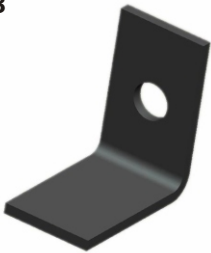

Thread | Hole | Length | Seal

**KFC364**

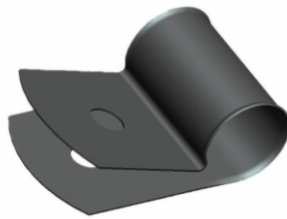

Thread | Hole | Length | Seal

**KFC365**

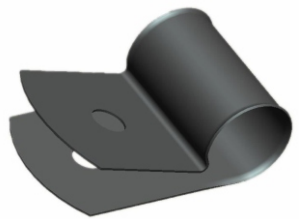

Thread | Hole | Length | Seal

**KFC366**

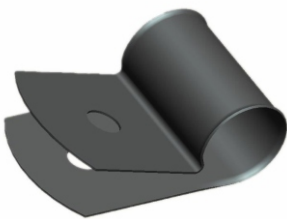

Thread | Hole | Length | Seal

**KFC367**

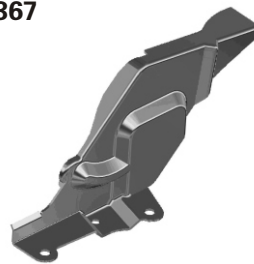

Thread | Hole | Length | Seal

**KFC368**



Thread | Hole | Length | Seal

**KFC369**



Thread | Hole | Length | Seal

**KFC369B**



Thread | Hole | Length | Seal

**KFC370**



Thread | Hole | Length | Seal

KFC371

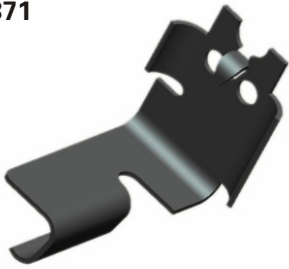

Thread | Hole | Length | Seal

KFC372



Thread | Hole | Length | Seal

KFC373



Thread | Hole | Length | Seal

KFC374



Thread | Hole | Length | Seal

KFC375



Thread | Hole | Length | Seal

KFC376



Thread | Hole | Length | Seal

KFC377



Thread | Hole | Length | Seal

KFC378



Thread | Hole | Length | Seal

KFC378-2



Thread | Hole | Length | Seal

KFC378-3



Thread | Hole | Length | Seal

KFC379



Thread | Hole | Length | Seal

KFC380



Thread | Hole | Length | Seal

KFC381

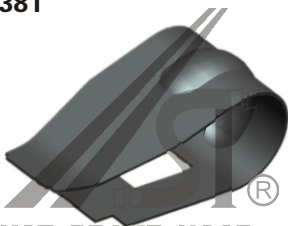

KST BRAKE HOSE

Thread | Hole | Length | Seal

KFC382

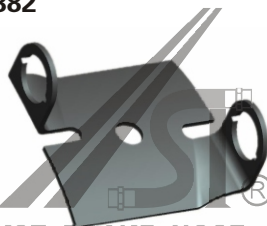

KST BRAKE HOSE

Thread | Hole | Length | Seal

KFC383

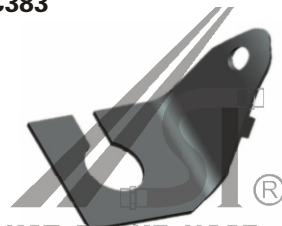

KST BRAKE HOSE

Thread | Hole | Length | Seal

**KFC383B**



Thread | Hole | Length | Seal

**KFC384**

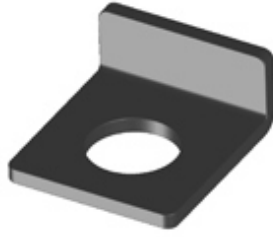

Thread | Hole | Length | Seal

**KFC385**



Thread | Hole | Length | Seal

**KFC386**



Thread | Hole | Length | Seal

**KFC387**



Thread | Hole | Length | Seal

**KFC388**



Thread | Hole | Length | Seal

**KFC389**



Thread | Hole | Length | Seal

**KFC390**



Thread | Hole | Length | Seal

**KFC391**



Thread | Hole | Length | Seal

**KFC392**



Thread | Hole | Length | Seal

**KFC393**



Thread | Hole | Length | Seal

**KFC393B**



Thread | Hole | Length | Seal

**KFC394**



Thread | Hole | Length | Seal

**KFC394B**



Thread | Hole | Length | Seal

**KFC395**



Thread | Hole | Length | Seal



**KFC396**



Thread | Hole | Length | Seal

**KFC397**



Thread | Hole | Length | Seal

**KFC397B**



Thread | Hole | Length | Seal

**KFC398**

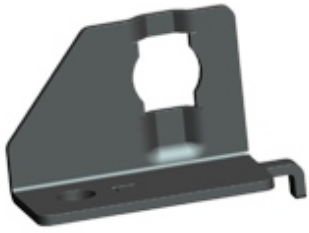

Thread | Hole | Length | Seal

**KFC398B**

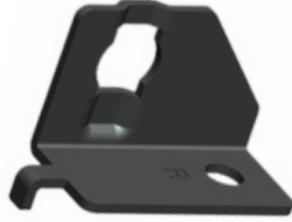

Thread | Hole | Length | Seal

**KFC399**



Thread | Hole | Length | Seal

**KFC399B**



Thread | Hole | Length | Seal

**KFC401**



Thread | Hole | Length | Seal

**KFC402**

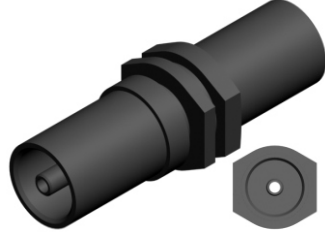

Thread | Hole | Length | Seal

**KFC403**

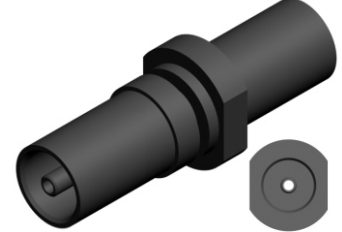

Thread | Hole | Length | Seal

**KFC404**



Thread | Hole | Length | Seal

**KFC405**

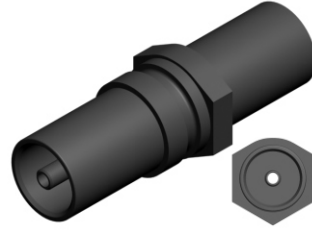

Thread | Hole | Length | Seal

**KFC406**



Thread | Hole | Length | Seal

**KFC407**



Thread | Hole | Length | Seal

**KFC408**



Thread | Hole | Length | Seal

**KFC409**

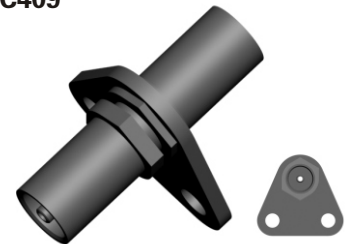

Thread | Hole | Length | Seal

**KFC410**

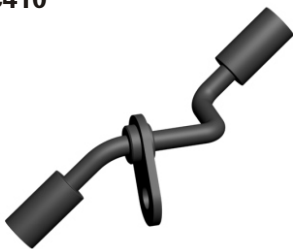

Thread | Hole | Length | Seal

**KFC410B**

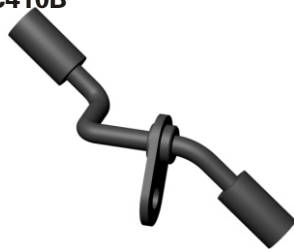

Thread | Hole | Length | Seal

**KFC411**

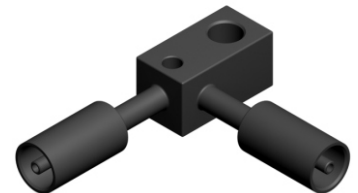

Thread | Hole | Length | Seal

**KFC411-2**



Thread | Hole | Length | Seal

**KFC412**



Thread | Hole | Length | Seal

**KFC413**

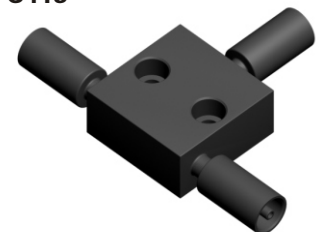

Thread | Hole | Length | Seal

**KFC414**

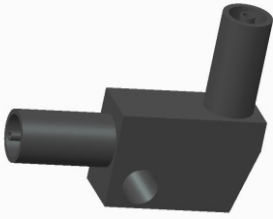

Thread | Hole | Length | Seal

**KFC415**

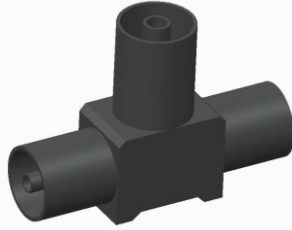

Thread | Hole | Length | Seal

**KFC416**



Thread | Hole | Length | Seal

**KFC416B**



Thread | Hole | Length | Seal

**KFC417**



Thread | Hole | Length | Seal

**KFC417B**



Thread | Hole | Length | Seal

**KFC418**



Thread | Hole | Length | Seal

**KFC419**



Thread | Hole | Length | Seal

**KFC419B**



Thread | Hole | Length | Seal

**KFC420**

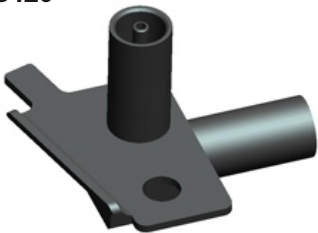

Thread | Hole | Length | Seal

**KFC420B**



Thread | Hole | Length | Seal

**KFC421**



Thread | Hole | Length | Seal

**KFC422**



Thread | Hole | Length | Seal

**KFC422B**



Thread | Hole | Length | Seal

**KFC501**

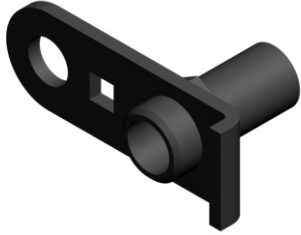

Thread | Hole | Length | Seal

**KFC502**



Thread | Hole | Length | Seal

**KFC502B**



Thread | Hole | Length | Seal

**KFC503-1**

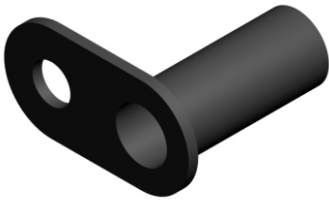

Thread | Hole | Length | Seal

**KFC503-2**



Thread | Hole | Length | Seal

**KFC503-3**



Thread | Hole | Length | Seal

**KFC503-4**



Thread | Hole | Length | Seal

**KFC503-5**



Thread | Hole | Length | Seal

**KFC503-6**



Thread | Hole | Length | Seal

**KFC503-7**



Thread | Hole | Length | Seal

**KFC503-8**



Thread | Hole | Length | Seal

**KFC503-9**



Thread | Hole | Length | Seal

**KFC503-10**



Thread | Hole | Length | Seal

**KFC503-11**



Thread | Hole | Length | Seal

**KFC503-12**



Thread | Hole | Length | Seal

**KFC503-13**



Thread | Hole | Length | Seal

**KFC504-1**



Thread | Hole | Length | Seal

**KFC504-2**



Thread | Hole | Length | Seal

**KFC505**



Thread | Hole | Length | Seal

**KFC505B**

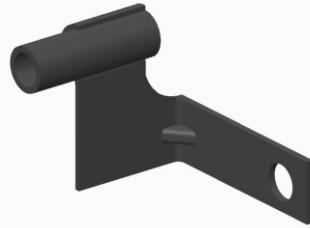

Thread | Hole | Length | Seal

**KFC506**



Thread | Hole | Length | Seal

**KFC506B**

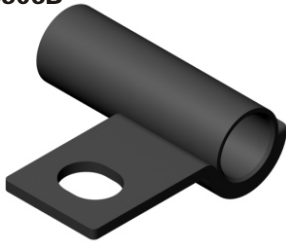

Thread | Hole | Length | Seal

**KFC507-1**



Thread | Hole | Length | Seal

**KFC507-2**

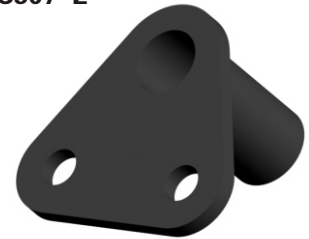

Thread | Hole | Length | Seal

**KFC507-3**



Thread | Hole | Length | Seal

**KFC507-4**



Thread | Hole | Length | Seal

**KFC507-5**



Thread | Hole | Length | Seal

**KFC507-6**



Thread | Hole | Length | Seal

**KFC508**



Thread | Hole | Length | Seal

**KFC509**



Thread | Hole | Length | Seal

**KFC509B**



Thread | Hole | Length | Seal

**KFC510**

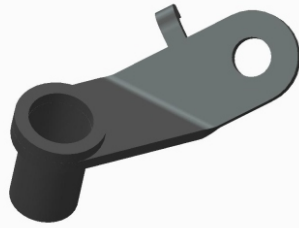

Thread | Hole | Length | Seal

**KFC510B**



Thread | Hole | Length | Seal

**KFC510-2**



Thread | Hole | Length | Seal

**KFC510-2B**



Thread | Hole | Length | Seal

**KFC511**

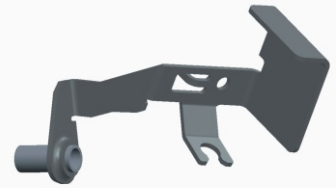

Thread | Hole | Length | Seal

**KFC511B**

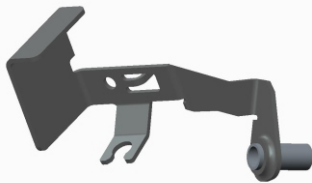

Thread | Hole | Length | Seal

**KFC512**



Thread | Hole | Length | Seal

**KFC512B**

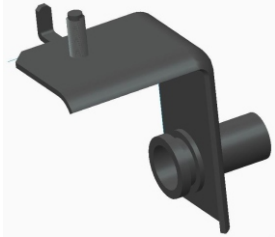

Thread | Hole | Length | Seal

**KFC513**



Thread | Hole | Length | Seal

**KFC513B**



Thread | Hole | Length | Seal

**KFC513-2**



Thread | Hole | Length | Seal

**KFC513-2B**



Thread | Hole | Length | Seal

**KFC513-3**



Thread | Hole | Length | Seal

**KFC513-3B**



Thread | Hole | Length | Seal

**KFC514**



Thread | Hole | Length | Seal

**KFC514B**



Thread | Hole | Length | Seal

**KFC515**



Thread | Hole | Length | Seal

**KFC515B**



Thread | Hole | Length | Seal

**KFC516**



Thread | Hole | Length | Seal

**KFC517**



Thread | Hole | Length | Seal

**KFC517B**



Thread | Hole | Length | Seal

**KFC518**



Thread | Hole | Length | Seal

**KFC518B**



Thread | Hole | Length | Seal

**KFC519**



Thread | Hole | Length | Seal

**KFC520**



Thread | Hole | Length | Seal

**KFC521**



Thread | Hole | Length | Seal

**KFC521B**



Thread | Hole | Length | Seal

**KFC522**



Thread | Hole | Length | Seal

**KFC523**



Thread | Hole | Length | Seal

**KFC524**



Thread | Hole | Length | Seal

**KFC525**



Thread | Hole | Length | Seal

**KFC526**



Thread | Hole | Length | Seal

**KFC527**



Thread | Hole | Length | Seal

**KFC527B**



Thread | Hole | Length | Seal

**KFC528**



Thread | Hole | Length | Seal

**KFC528B**



Thread | Hole | Length | Seal

**KFC529**



Thread | Hole | Length | Seal

**KFC529B**



Thread | Hole | Length | Seal

**KFC530**



Thread | Hole | Length | Seal

**KFC531**



Thread | Hole | Length | Seal

**KFC531B**



Thread | Hole | Length | Seal

**KFC532**

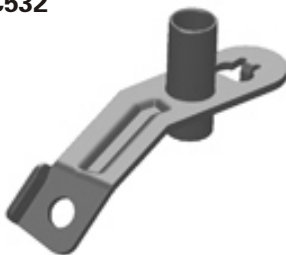

Thread | Hole | Length | Seal

**KFC533**



Thread | Hole | Length | Seal

**KFC533B**



Thread | Hole | Length | Seal



**KFC534**



Thread | Hole | Length | Seal

**KFC534B**



Thread | Hole | Length | Seal

**KFC535**



Thread | Hole | Length | Seal

**KFC536**



Thread | Hole | Length | Seal

**KFC537**



Thread | Hole | Length | Seal

**KFC538**



Thread | Hole | Length | Seal

**KFC538B**



Thread | Hole | Length | Seal

**KFC539**



Thread | Hole | Length | Seal

**KFC539B**



Thread | Hole | Length | Seal

**KFC540**



Thread | Hole | Length | Seal

**KFC540B**



Thread | Hole | Length | Seal

**KFC541**



Thread | Hole | Length | Seal

**KFC541B**



Thread | Hole | Length | Seal

**KFC542**



Thread | Hole | Length | Seal

**KFC542B**



Thread | Hole | Length | Seal

**KFC543**



Thread | Hole | Length | Seal

**KFC543B**



Thread | Hole | Length | Seal

**KFC544**



Thread | Hole | Length | Seal

**KFC544B**

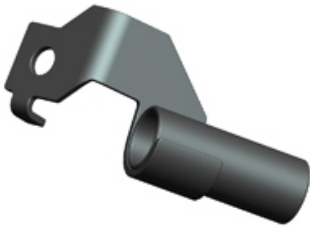

Thread | Hole | Length | Seal

**KFC545**



Thread | Hole | Length | Seal

**KFC545B**



Thread | Hole | Length | Seal

**KFC546**



Thread | Hole | Length | Seal

**KFC546B**



Thread | Hole | Length | Seal

**KFC547**



Thread | Hole | Length | Seal

**KFC547B**



Thread | Hole | Length | Seal

**KFC548**



Thread | Hole | Length | Seal

**KFC549**



Thread | Hole | Length | Seal

**KFC549B**



Thread | Hole | Length | Seal

**KFC550**



Thread | Hole | Length | Seal

**KFC550B**



Thread | Hole | Length | Seal

**KFC551**



Thread | Hole | Length | Seal

**KFC552**



Thread | Hole | Length | Seal

**KFC553**



Thread | Hole | Length | Seal

**KFC553B**



Thread | Hole | Length | Seal

**KFC554**



Thread | Hole | Length | Seal

**KFC554B**



Thread | Hole | Length | Seal

**KFC555**



Thread | Hole | Length | Seal

**KFC555B**



Thread | Hole | Length | Seal

**KFC601**

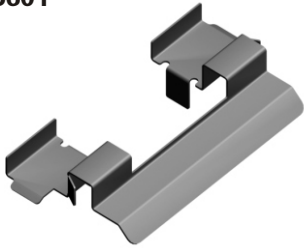

Thread | Hole | Length | Seal

**KFC602**

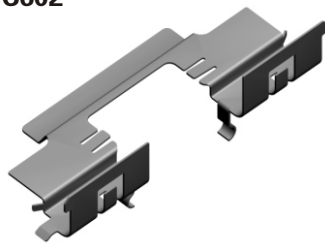

Thread | Hole | Length | Seal

**KFC603**

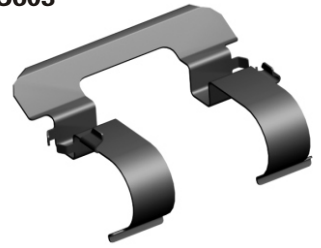

Thread | Hole | Length | Seal

**KFC604**



Thread | Hole | Length | Seal

**KFC605**

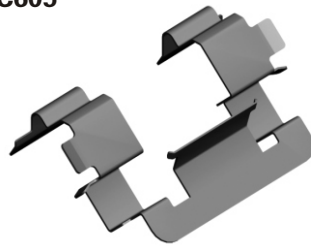

Thread | Hole | Length | Seal

**KFC606**

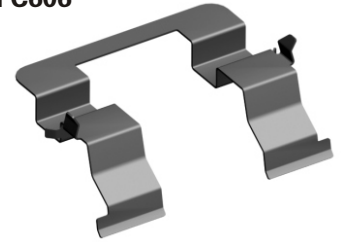

Thread | Hole | Length | Seal

**KFC607**



Thread | Hole | Length | Seal

**KFC608**

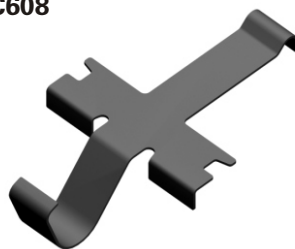

Thread | Hole | Length | Seal

**KFC609**

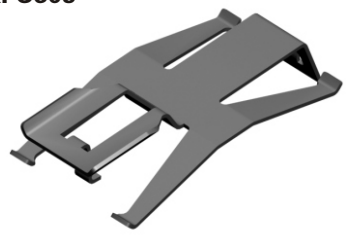

Thread | Hole | Length | Seal

**KFC610**

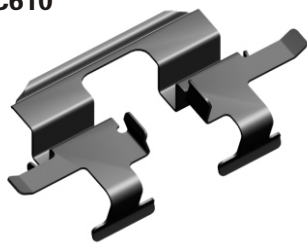

Thread | Hole | Length | Seal

**KFC611**



Thread | Hole | Length | Seal

**KFC612**

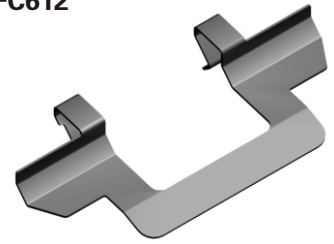

Thread | Hole | Length | Seal

**KFC613**

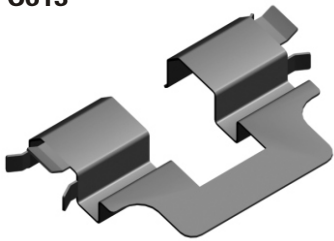

Thread | Hole | Length | Seal

**KFC614**

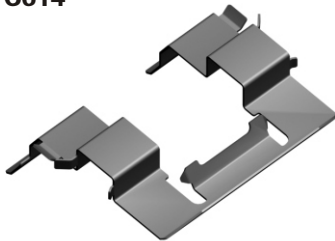

Thread | Hole | Length | Seal

**KFC615**

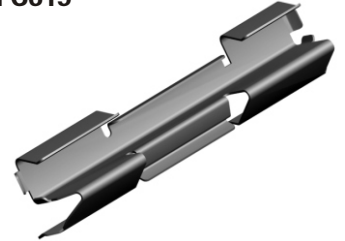

Thread | Hole | Length | Seal

**KFC616**

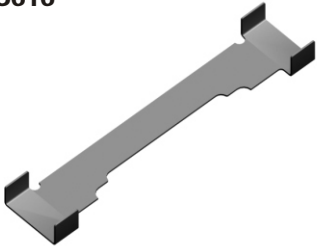

Thread | Hole | Length | Seal

**KFC617**

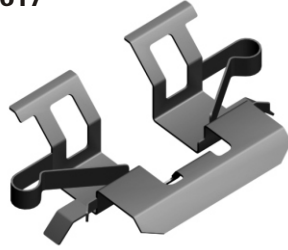

Thread | Hole | Length | Seal

**KFC618**

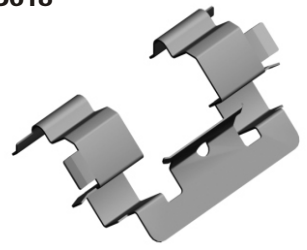

Thread | Hole | Length | Seal

**KFC619**

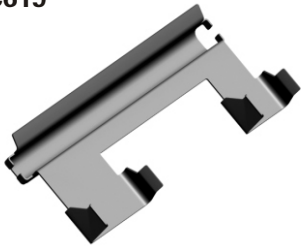

Thread | Hole | Length | Seal

**KFC620**

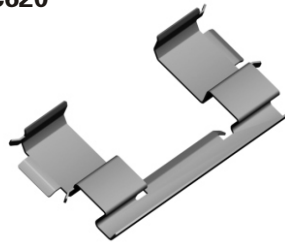

Thread | Hole | Length | Seal

**KFC621**

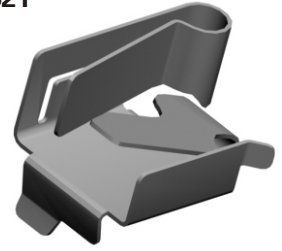

Thread | Hole | Length | Seal

**KFC622**

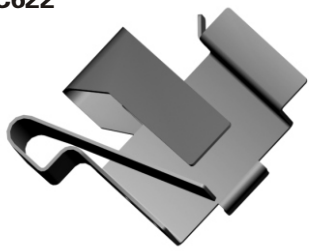

Thread | Hole | Length | Seal

**KFC623**

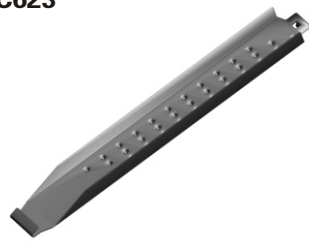

Thread | Hole | Length | Seal

**KFC624**

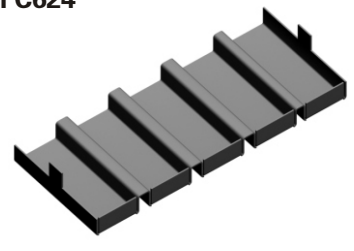

Thread | Hole | Length | Seal

**KFC625**

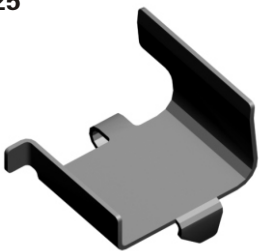

Thread | Hole | Length | Seal

**KFC626**

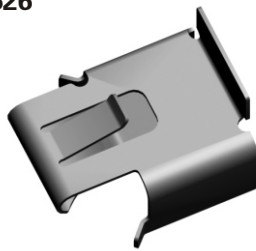

Thread | Hole | Length | Seal

**KFC627**



Thread | Hole | Length | Seal

**KFC628**

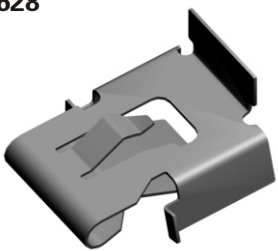

Thread | Hole | Length | Seal

**KFC629**

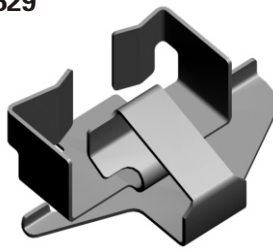

Thread | Hole | Length | Seal

**KFC630**



Thread | Hole | Length | Seal

KFC631



Thread | Hole | Length | Seal

KFC632



Thread | Hole | Length | Seal

KFC633



Thread | Hole | Length | Seal

KFC634



Thread | Hole | Length | Seal

KFC635



Thread | Hole | Length | Seal

KFC636

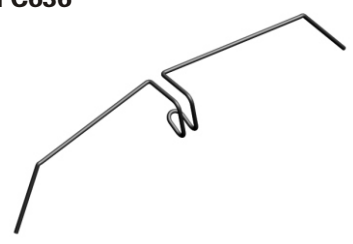

Thread | Hole | Length | Seal

KFC637



Thread | Hole | Length | Seal

KFC637B



Thread | Hole | Length | Seal

KFC638



Thread | Hole | Length | Seal

KFC639



Thread | Hole | Length | Seal

**KFC3001**



Thread | Hole | Length | Seal

**KFC3002**



Thread | Hole | Length | Seal

**KFC3003**



Thread | Hole | Length | Seal

**KFC3003B**



Thread | Hole | Length | Seal

**KFC3004**



Thread | Hole | Length | Seal

**KFC3004B**



Thread | Hole | Length | Seal

**KFC3005**



Thread | Hole | Length | Seal

**KFC3005B**



Thread | Hole | Length | Seal

**KFC3006**



Thread | Hole | Length | Seal

**KFC3006B**



Thread | Hole | Length | Seal

**KFC3007**



Thread | Hole | Length | Seal

**KFC3008**



Thread | Hole | Length | Seal

**KFC3008B**



Thread | Hole | Length | Seal

**KFC3009**

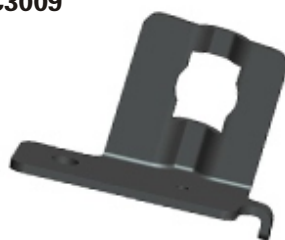

Thread | Hole | Length | Seal

**KFC3010**



Thread | Hole | Length | Seal

**KFC3010B**



Thread | Hole | Length | Seal

**KFC3011**



Thread | Hole | Length | Seal

**KFC3011B**



Thread | Hole | Length | Seal

**KFC3012**



Thread | Hole | Length | Seal

**KFC3012B**



Thread | Hole | Length | Seal

**KFC3013**



Thread | Hole | Length | Seal

**KFC3013B**



Thread | Hole | Length | Seal

**KFC3014**



Thread | Hole | Length | Seal

**KFC3015**



Thread | Hole | Length | Seal

**KFC3015B**



Thread | Hole | Length | Seal

**KFC3016**



Thread | Hole | Length | Seal

**KFC3017**



Thread | Hole | Length | Seal

**KFC3018**



Thread | Hole | Length | Seal

**KFC3018B**



Thread | Hole | Length | Seal

**KFC3019**



Thread | Hole | Length | Seal



**KFC3019B**



Thread | Hole | Length | Seal

**KFC3020**



Thread | Hole | Length | Seal

**KFC3020B**

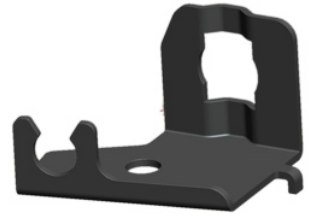

Thread | Hole | Length | Seal

**KFC3021**



Thread | Hole | Length | Seal

**KFC3022**



Thread | Hole | Length | Seal

**KFC3022B**



Thread | Hole | Length | Seal

**KFC3023**



Thread | Hole | Length | Seal

**KFC3023B**



Thread | Hole | Length | Seal

**KFC3024**



Thread | Hole | Length | Seal

**KFC3024B**



Thread | Hole | Length | Seal

**KFC3025**



Thread | Hole | Length | Seal

**KFC3026**



Thread | Hole | Length | Seal

**KFC3026B**



Thread | Hole | Length | Seal

**KFC3027**



Thread | Hole | Length | Seal

**KFC3027B**



Thread | Hole | Length | Seal

**KFC3028**



Thread | Hole | Length | Seal

**KFC3029**



Thread | Hole | Length | Seal

**KFC3030**



Thread | Hole | Length | Seal

**KFC3031**



Thread | Hole | Length | Seal

**KFC3032**



Thread | Hole | Length | Seal

**KFC3032B**

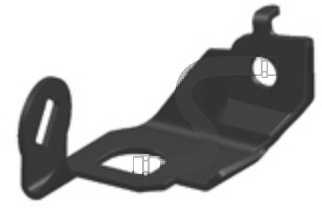

Thread | Hole | Length | Seal

**KFC3033**



Thread | Hole | Length | Seal

**KFC3034**



Thread | Hole | Length | Seal

**KFC3035**



Thread | Hole | Length | Seal

**KFC3036**



Thread | Hole | Length | Seal

**KFC3037**

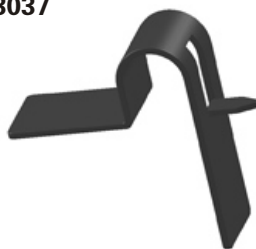

Thread | Hole | Length | Seal

**KFC3038**



Thread | Hole | Length | Seal

**KFC3039**



Thread | Hole | Length | Seal

**KFC3040**



Thread | Hole | Length | Seal

**KFC3041**



Thread | Hole | Length | Seal

KFC3042



Thread | Hole | Length | Seal

KFC3043



Thread | Hole | Length | Seal

KFC3044



Thread | Hole | Length | Seal

KFC3045



Thread | Hole | Length | Seal

KFC3046



Thread | Hole | Length | Seal

KFC3047



Thread | Hole | Length | Seal

KFC3048



Thread | Hole | Length | Seal

KFC3049



Thread | Hole | Length | Seal

KFC3050



Thread | Hole | Length | Seal

KFC3051



Thread | Hole | Length | Seal

KFC3052



Thread | Hole | Length | Seal

KFC3053



Thread | Hole | Length | Seal

KFC3054

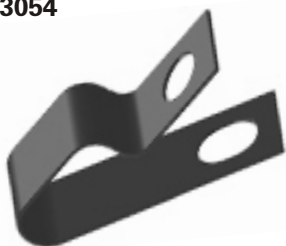

Thread | Hole | Length | Seal

KFC3055



Thread | Hole | Length | Seal

KFC3056



Thread | Hole | Length | Seal

**KFC3057**



Thread | Hole | Length | Seal

**KFC3058**



Thread | Hole | Length | Seal

**KFC3059**



Thread | Hole | Length | Seal

**KFC3060**



Thread | Hole | Length | Seal

**KFC3061**



Thread | Hole | Length | Seal

**KFC3062**



Thread | Hole | Length | Seal

**KFC3063**



Thread | Hole | Length | Seal

**KFC3064**



Thread | Hole | Length | Seal

**KFC3065**



Thread | Hole | Length | Seal

**KFC3066**



Thread | Hole | Length | Seal

**KFC3067**



Thread | Hole | Length | Seal

**KFC3068**



Thread | Hole | Length | Seal

**KFC3069**



Thread | Hole | Length | Seal

**KFC3070**



Thread | Hole | Length | Seal

**KFC3071**



Thread | Hole | Length | Seal

**KFC3072**



Thread | Hole | Length | Seal

**KFC3073**



Thread | Hole | Length | Seal

**KFC3074**



Thread | Hole | Length | Seal

**KFC3075**



Thread | Hole | Length | Seal

**KFC3076**



Thread | Hole | Length | Seal

**KFC3077**



Thread | Hole | Length | Seal

**KFC3078**



Thread | Hole | Length | Seal

**KFC3079**



Thread | Hole | Length | Seal

**KFC3080**



Thread | Hole | Length | Seal

**KFC3081**



Thread | Hole | Length | Seal

**KFC3082**



Thread | Hole | Length | Seal

**KFC3083**

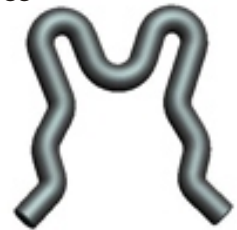

Thread | Hole | Length | Seal

**KFC3084**

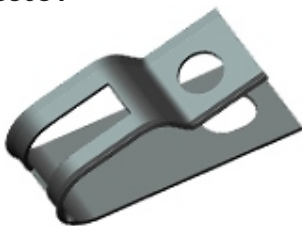

Thread | Hole | Length | Seal

**KFC3085**



Thread | Hole | Length | Seal

**KFC3086**



Thread | Hole | Length | Seal

**KFC3087**



Thread | Hole | Length | Seal

**KFC3088**

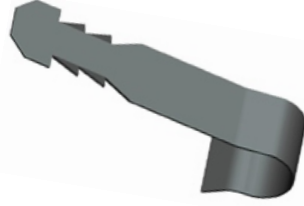

Thread | Hole | Length | Seal

**KFC3089**



Thread | Hole | Length | Seal

**KFC3090**



Thread | Hole | Length | Seal

**KFC3091**



Thread | Hole | Length | Seal

**KFC3091B**



Thread | Hole | Length | Seal

**KFC3092**



Thread | Hole | Length | Seal

**KFC3093**



Thread | Hole | Length | Seal

**KFC3093B**



Thread | Hole | Length | Seal

**KFC3094**



Thread | Hole | Length | Seal

**KFC3095**



Thread | Hole | Length | Seal

**KFC3096**



Thread | Hole | Length | Seal

**KFC3096B**



Thread | Hole | Length | Seal

**KFC3097**



Thread | Hole | Length | Seal

**KFC3097B**



Thread | Hole | Length | Seal

**KFC3098**



Thread | Hole | Length | Seal

**KFC3099**



Thread | Hole | Length | Seal

**KFC3100**



Thread | Hole | Length | Seal

**KFC3101**



Thread | Hole | Length | Seal

**KFC3102**



Thread | Hole | Length | Seal

**KFC3103**



Thread | Hole | Length | Seal

**KFC3103B**



Thread | Hole | Length | Seal

**KFC3104**



Thread | Hole | Length | Seal

**KFC3105**

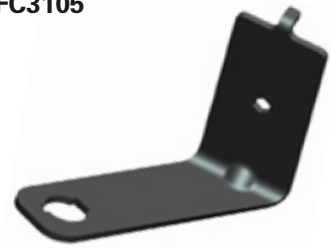

Thread | Hole | Length | Seal

**KFC3106**



Thread | Hole | Length | Seal

**KFC3106B**



Thread | Hole | Length | Seal

**KFC3107**



Thread | Hole | Length | Seal

**KFC3107B**



Thread | Hole | Length | Seal

**KFC3108**



Thread | Hole | Length | Seal

**KFC3109**

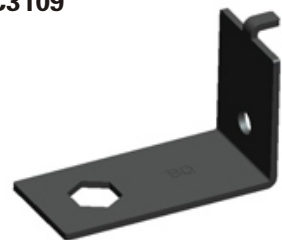

Thread | Hole | Length | Seal

**KFC3110**



Thread | Hole | Length | Seal

**KFC3110B**



Thread | Hole | Length | Seal

**KFC3111**



Thread | Hole | Length | Seal

**KFC3111B**



Thread | Hole | Length | Seal

**KFC3112**



Thread | Hole | Length | Seal

**KFC3113**



Thread | Hole | Length | Seal

**KFC3113B**



Thread | Hole | Length | Seal

**KFC3114**



Thread | Hole | Length | Seal

**KFC3115**



Thread | Hole | Length | Seal

**KFC3116**



Thread | Hole | Length | Seal

**KFC3117**

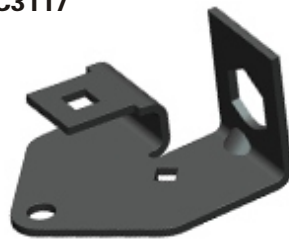

Thread | Hole | Length | Seal

**KFC3117B**

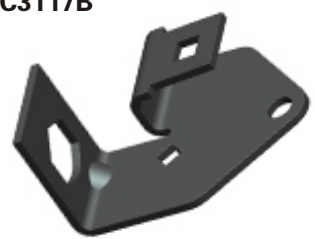

Thread | Hole | Length | Seal



**KFR01**

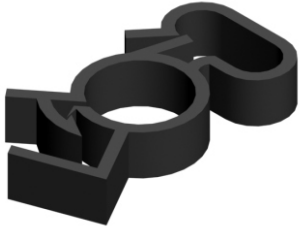

Thread | Seat | Length | Seal

**KFR02**



Thread | Seat | Length | Seal

**KFR02-2**



Thread | Seat | Length | Seal

**KFR03**



Thread | Seat | Length | Seal

**KFR03-2**



Thread | Seat | Length | Seal

**KFR04**



Thread | Seat | Length | Seal

**KFR04-2**



Thread | Seat | Length | Seal

**KFR05**



Thread | Seat | Length | Seal

**KFR06**

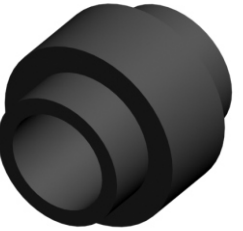

Thread | Seat | Length | Seal

**KFR07**

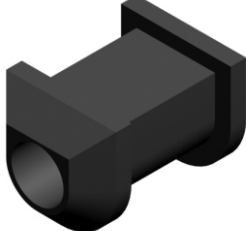

Thread | Seat | Length | Seal

**KFR07-2**



Thread | Seat | Length | Seal

**KFR08**



Thread | Seat | Length | Seal

**KFR09**



Thread | Seat | Length | Seal

**KFR09-2**



Thread | Seat | Length | Seal

**KFR09-3**



Thread | Seat | Length | Seal

**KFR09-4**



Thread | Seat | Length | Seal

**KFR09-5**

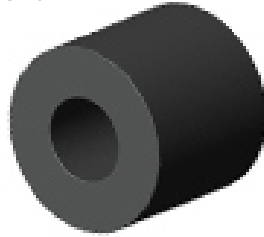

Thread | Seat | Length | Seal

**KFR09-6**



Thread | Seat | Length | Seal

**KFR09-7**



Thread | Seat | Length | Seal

**KFR10**



Thread | Seat | Length | Seal

**KFR11**



Thread | Seat | Length | Seal

**KFR12**



Thread | Seat | Length | Seal

**KFR13**



Thread | Seat | Length | Seal

**KFR13-2**



Thread | Seat | Length | Seal

**KFR14**

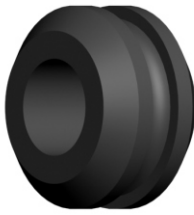

Thread | Seat | Length | Seal

**KFR15**



Thread | Seat | Length | Seal

**KFR16**

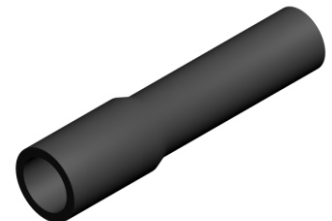

Thread | Seat | Length | Seal

**KFR16-2**

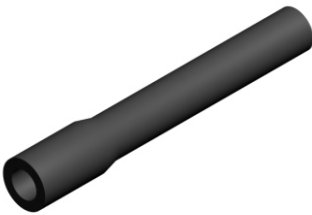

Thread | Seat | Length | Seal

**KFR17**



Thread | Seat | Length | Seal

**KFR17-2**



Thread | Seat | Length | Seal

**KFR18**



Thread | Seat | Length | Seal

**KFR18-2**



Thread | Seat | Length | Seal

**KFR18-3**



Thread | Seat | Length | Seal

**KFR18-4**



Thread | Seat | Length | Seal

**KFR18-5**



Thread | Seat | Length | Seal

**KFR18-6**

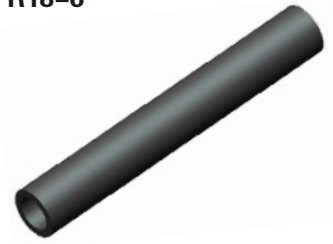

Thread | Seat | Length | Seal

**KFR18-7**



Thread | Seat | Length | Seal

**KFR18-8**



Thread | Seat | Length | Seal

**KFR18-9**

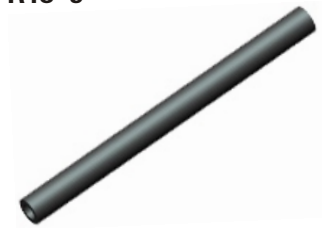

Thread | Seat | Length | Seal

**KFR18-10**



Thread | Seat | Length | Seal

**KFR18-11**

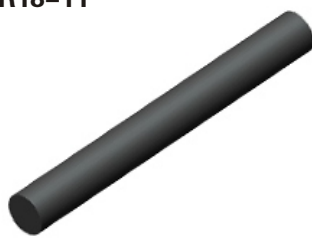

Thread | Seat | Length | Seal

**KFR18-12**



Thread | Seat | Length | Seal

**KFR18-13**



Thread | Seat | Length | Seal

**KFR18-14**

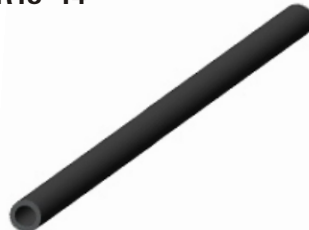

Thread | Seat | Length | Seal

**KFR18-15**



Thread | Seat | Length | Seal

**KFR19**



Thread | Seat | Length | Seal

**KFR20**



Thread | Seat | Length | Seal

**KFR21**



Thread | Seat | Length | Seal

**KFR22**

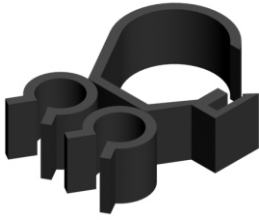

Thread | Seat | Length | Seal

**KFR23**



Thread | Seat | Length | Seal

**KFR24**



Thread | Seat | Length | Seal

**KFR24-2**



Thread | Seat | Length | Seal

**KFR25**



Thread | Seat | Length | Seal

**KFR26**



Thread | Seat | Length | Seal

**KFR27**



Thread | Seat | Length | Seal

**KFR28**



Thread | Seat | Length | Seal

**KFR29**

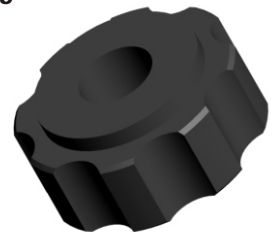

Thread | Seat | Length | Seal

**KFR30**



Thread | Seat | Length | Seal

**KFR31**

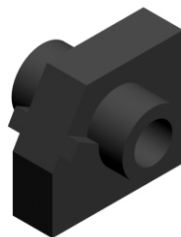

Thread | Seat | Length | Seal

**KFR32**

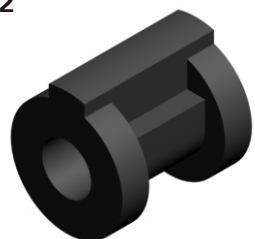

Thread | Seat | Length | Seal

**KFR33**



Thread | Seat | Length | Seal

**KFR34**



Thread | Seat | Length | Seal

**KFR35**

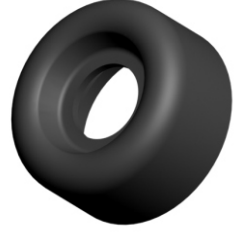

Thread | Seat | Length | Seal

**KFR36**

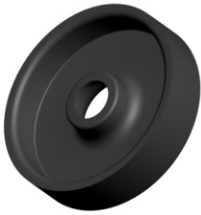

Thread | Seat | Length | Seal

**KFR37**

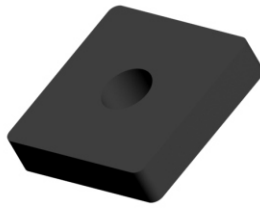

Thread | Seat | Length | Seal

**KFR38**



Thread | Seat | Length | Seal

**KFR39**



Thread | Seat | Length | Seal

**KFR40**



Thread | Seat | Length | Seal

**KFR41**



Thread | Seat | Length | Seal

**KFR42**



Thread | Seat | Length | Seal

**KFR43**



Thread | Seat | Length | Seal

**KFR44**



Thread | Seat | Length | Seal

**KFR45**

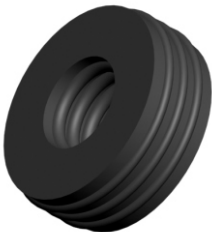

Thread | Seat | Length | Seal

**KFR46**

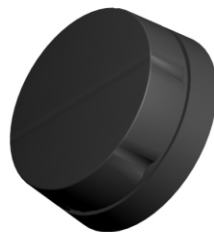

Thread | Seat | Length | Seal

**KFR47**



Thread | Seat | Length | Seal

**KFR48**



Thread | Seat | Length | Seal

**KFR49**

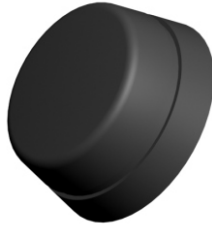

Thread | Seat | Length | Seal

**KFR50**



Thread | Seat | Length | Seal

**KFR51**



Thread | Seat | Length | Seal

**KFR52**



Thread | Seat | Length | Seal

**KFR53**



Thread | Seat | Length | Seal

**KFR54**



Thread | Seat | Length | Seal

**KFR55**



Thread | Seat | Length | Seal

**KFR56**

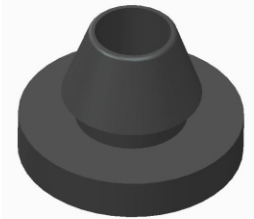

Thread | Seat | Length | Seal

**KFR57**

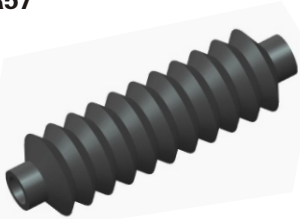

Thread | Seat | Length | Seal

**KFR57-2**



Thread | Seat | Length | Seal

**KFR57-3**

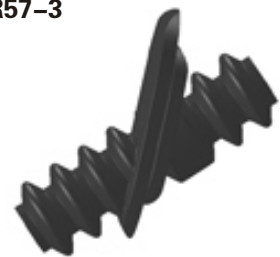

Thread | Seat | Length | Seal

**KFR58**

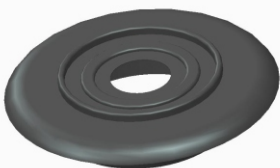

Thread | Seat | Length | Seal

**KFR59**



Thread | Seat | Length | Seal

**KFR60**



Thread | Seat | Length | Seal

**KFR60B**



Thread | Seat | Length | Seal

**KFR61**



Thread | Seat | Length | Seal

**KFR61-2**



Thread | Seat | Length | Seal

**KFR62**



Thread | Seat | Length | Seal

**KFR63**



Thread | Seat | Length | Seal

**KFR64**



Thread | Seat | Length | Seal

**KFR65**

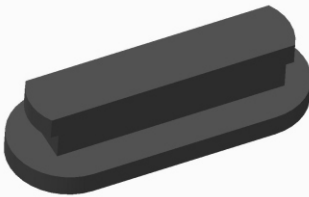

Thread | Seat | Length | Seal

**KFR66**

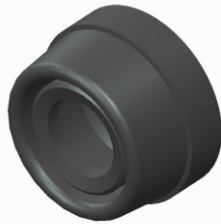

Thread | Seat | Length | Seal

**KFR67**



Thread | Seat | Length | Seal

**KFR68**



Thread | Seat | Length | Seal

**KFR69**



Thread | Seat | Length | Seal

**KFR70**



Thread | Seat | Length | Seal

**KFR71**



Thread | Seat | Length | Seal

**KFR72**

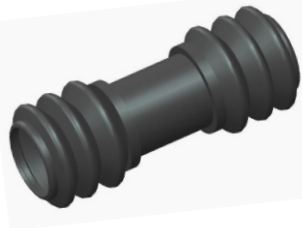

Thread | Seat | Length | Seal

**KFR73**



Thread | Seat | Length | Seal

**KFR74**



Thread | Seat | Length | Seal

**KFR75**



Thread | Seat | Length | Seal

**KFR76**



Thread | Seat | Length | Seal

**KFR76-2**



Thread | Seat | Length | Seal

**KFR77**

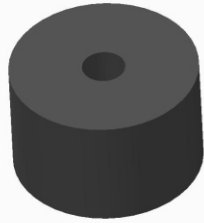

Thread | Seat | Length | Seal

**KFR78**

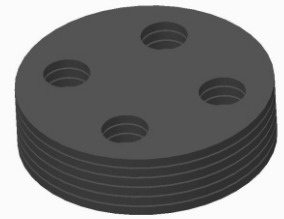

Thread | Seat | Length | Seal

**KFR79**



Thread | Seat | Length | Seal

**KFR79-2**

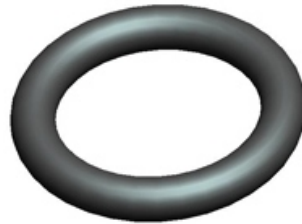

Thread | Seat | Length | Seal

**KFR79-3**



Thread | Seat | Length | Seal

**KFR80**



Thread | Seat | Length | Seal

**KFR81**



Thread | Seat | Length | Seal

**KFR82**



Thread | Seat | Length | Seal

**KFR83**



Thread | Seat | Length | Seal

**KFR84**



Thread | Seat | Length | Seal

**KFR85**



Thread | Seat | Length | Seal



**KFR86**



Thread | Seat | Length | Seal

**KFR87**



Thread | Seat | Length | Seal

**KFR88**



Thread | Seat | Length | Seal

**KFR89**



Thread | Seat | Length | Seal

**KFR90**



Thread | Seat | Length | Seal

**KFR91**



Thread | Seat | Length | Seal

**KFR92**



Thread | Seat | Length | Seal

**KFR93**



Thread | Seat | Length | Seal

**KFR94**



Thread | Seat | Length | Seal

**KFR95**

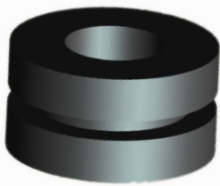

Thread | Seat | Length | Seal

**KFR96**



Thread | Seat | Length | Seal

**KFR97**



Thread | Seat | Length | Seal

**KFR98**

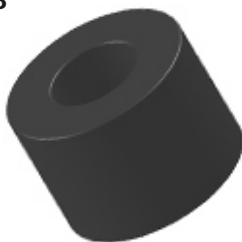

Thread | Seat | Length | Seal

**KFR99**

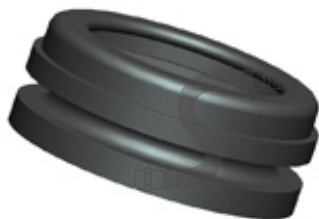

Thread | Seat | Length | Seal

**KFR100**

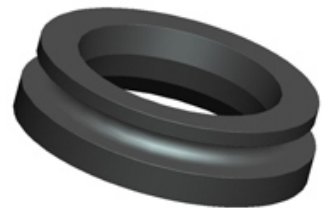

Thread | Seat | Length | Seal

**KFR101**



Thread | Seat | Length | Seal

**KFR101B**



Thread | Seat | Length | Seal

**KFR102**



Thread | Seat | Length | Seal

**KFR103**



Thread | Seat | Length | Seal

**KFR104**



Thread | Seat | Length | Seal

**KFR105**



Thread | Seat | Length | Seal

**KFR106**



Thread | Seat | Length | Seal

**KFR107**



Thread | Seat | Length | Seal

**KFR108**



Thread | Seat | Length | Seal

**KFR109**



Thread | Seat | Length | Seal

**KFR110**



Thread | Seat | Length | Seal

**KFR111**



Thread | Seat | Length | Seal

**KFR112**

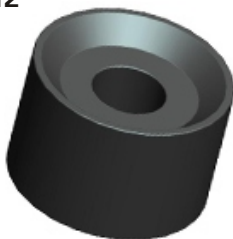

Thread | Seat | Length | Seal

**KFR113**



Thread | Seat | Length | Seal

**KFR114**



Thread | Seat | Length | Seal

**KFR115**



Thread | Seat | Length | Seal

**KFR116**



Thread | Seat | Length | Seal

**KFR117**



Thread | Seat | Length | Seal

**KFR118**



Thread | Seat | Length | Seal

**KFR119**



Thread | Seat | Length | Seal

**KFR120**



Thread | Seat | Length | Seal

**KFR121**



Thread | Seat | Length | Seal

**KFR122**



Thread | Seat | Length | Seal

**KFR122B**



Thread | Seat | Length | Seal

**KFR123**



Thread | Seat | Length | Seal

**KFR124**



Thread | Seat | Length | Seal

**KFR125**



Thread | Seat | Length | Seal

**KFR126**



Thread | Seat | Length | Seal

**KFR127**



Thread | Seat | Length | Seal

**KFR128**



Thread | Seat | Length | Seal

**KFR129**



Thread | Seat | Length | Seal

**KFR130**

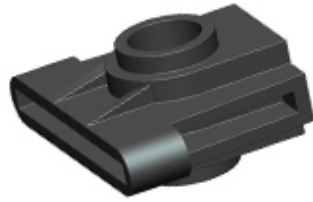

Thread | Seat | Length | Seal

**KFR131**



Thread | Seat | Length | Seal

**KFR132**

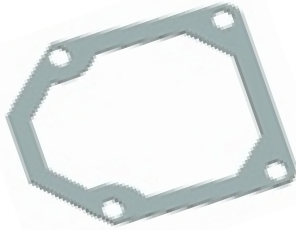

Thread | Seat | Length | Seal

**KFR133**



Thread | Seat | Length | Seal

**KFR134**



Thread | Seat | Length | Seal

**KFR135**



Thread | Seat | Length | Seal

**KFR136**

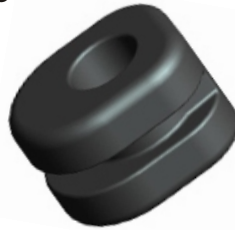

Thread | Seat | Length | Seal

**KFR137**



Thread | Seat | Length | Seal

**KFR138**



Thread | Seat | Length | Seal

**KFR139**

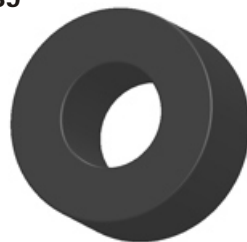

Thread | Seat | Length | Seal

**KFR140**



Thread | Seat | Length | Seal

**KFR141**



Thread | Seat | Length | Seal

**KFR142**



Thread | Seat | Length | Seal

**KFR143**



Thread | Seat | Length | Seal

**KFR144**



Thread | Seat | Length | Seal

**KFR145**



Thread | Seat | Length | Seal

**KFR146**

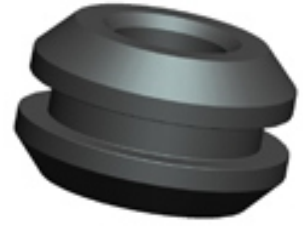

Thread | Seat | Length | Seal

**KFR147**

Thread | Seat | Length | Seal

**KFR148**



Thread | Seat | Length | Seal

**KFR149**

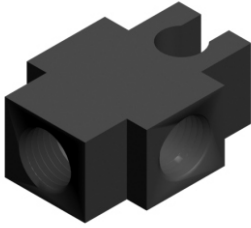

Thread | Seat | Length | Seal

**KFST01**

Thread	Width	Length
3--3/8X24	21.5	31

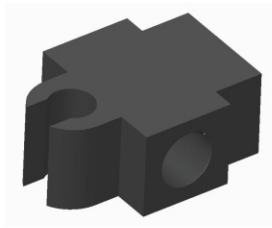
**KFST01-2**

Thread	Width	Length
3--7/16X24--3/8X24	21.5	31

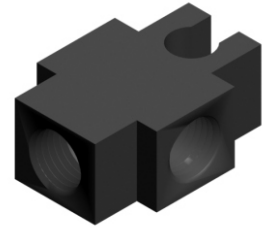
**KFST01-3**

Thread	Width	Length
3--M10X1	21.5	31

**KFST02**

Thread	Width	Length
2--3/8X24--7/16X24	20	24

**KFST03**

Thread	Width	Length
3--M10X1.25	33	34

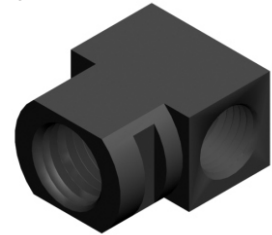
**KFST04**

Thread	Width	Length
2--3/8X24--7/16X20	19	23

**KFST04-2**

Thread	Width	Length
3--7/16X24	14	26

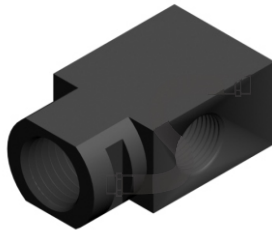
**KFST05**

Thread	Width	Length
2--3/8X24--7/16X24	19	33

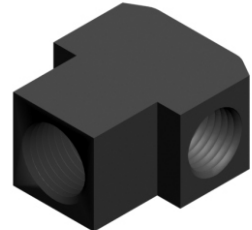
**KFST06**

Thread	Width	Length
2--3/8X24--7/16X24	22	25

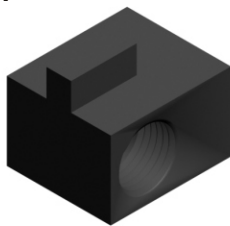
**KFST07**

Thread	Seat	Length
2--7/16X24--3/8X24	H14	27

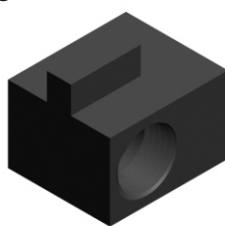
**KFST08**

Thread	Seat	Length
2--3/8X24--7/16X24	H11	32

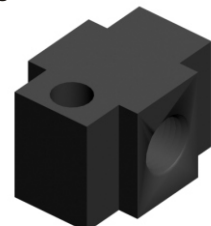
**KFST09**

Thread	Width	Length
3--3/8X24	22	25

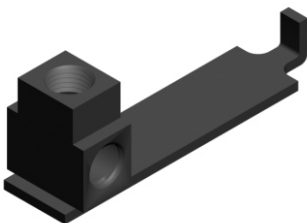
**KFST10**

Thread	Width	Length
2--7/16X24--3/8X24	20	24

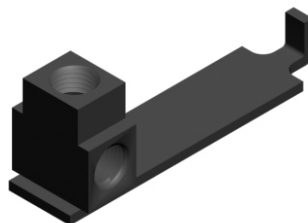
**KFST10-2**

Thread	Width	Length
2--3/8X24--7/16X24	20	24

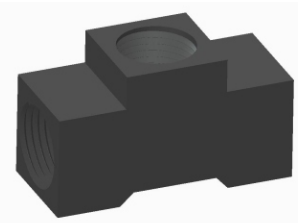
**KFST11**

Thread	Width	Length
3/8X24--3/8X24--3/8X24	28	16

**KFST11-2**

Thread	Width	Length
3/8X24-3/8X24-3/8X24	13	

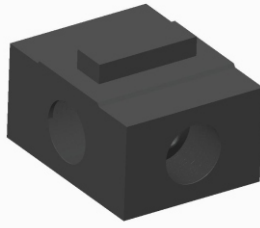
**KFST12**

Thread	Width	Length
3/8X24-3/8X24-3/8X24-3/8X24	21	26.5

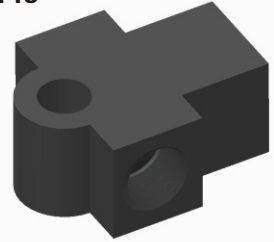
**KFST13**

Thread	Width	Length
3/8X24-3/8X24-3/8X24	25	32

**KFST14**

Thread	Width	Length
M10X1-M10X1-M10X1	32	40

**KFST14-2**

Thread	Width	Length
M10X1-M10X1-M10X1	30	30

**KFST14-3**

Thread	Width	Length
3-M10X1	30	30

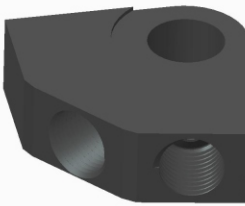
**KFST15**

Thread	Seat	Length
M10X1-M10X1	Φ12	

**KFST15-2**

Thread	Seat	Length
3-3/8X24	29	

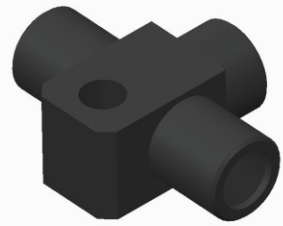
**KFST16**

Thread	Width	Length
M10X1-M10X1-M10X1	41	30.5

**KFST17**

Thread	Width	Length
M10X1-M10X1-M10X1	35	36

**KFST17-2**

Thread	Width	Length
M10X1-M10X1-M10X1	35	36

**KFST18**

Thread	Width	Length
M10X1-M10X1-M10X1	42	42

**KFST19**

Thread	Width	Length
M10X1-M10X1-M10X1	30	48

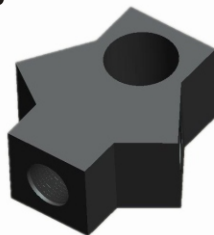
**KFST20**

Thread	Width	Length
3/8X24-3/8X24-3/8X24	31	35

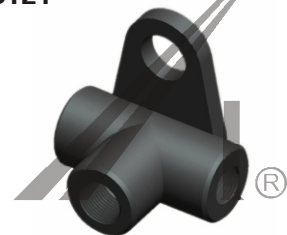
**KFST21**

Thread	Width	Length
3/8X24-3/8X24-3/8X24	35	

KFST22



Width	Hole	Length	Bend
35	Φ8.6	39	3-M10X1

KFST23

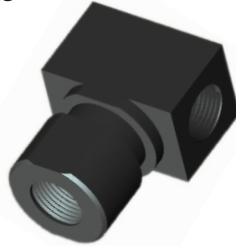

Thread	Width	Length
3/8X24—3/8X24—3/8X24	21.5	30

KFST24

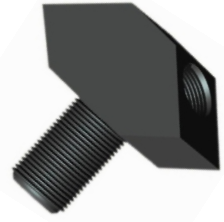

Thread	Width	Length
3/8X24—3/8X24—3/8X24	30.6	31.5

KFST25

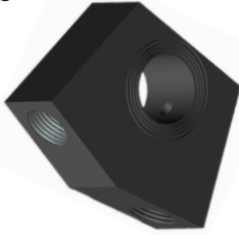

Width	Hole	Length	Bend
35	Φ11	25	3/8X24--3/8X24

KFST26

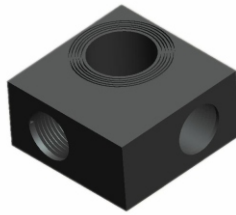

Width	Hole	Length	Bend
25	Φ11	25	3/8X24--3/8X24

KFST27

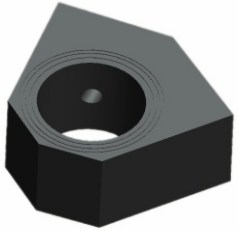

Thread	Hole	Width	Length
2-7/16X24	Φ15	32	31.5

KFST28



Thread	Hole	Width	Length
3--7/16X24		28	

KFST29

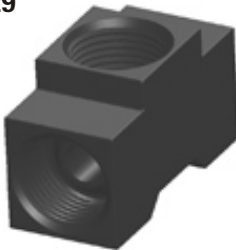

Thread	Hole	Width	Length
3-1/2X20		15	32

KFST30



Thread	Hole	Width	Length
1/2X20--1/8X27NPTF		16	26

KFST31



Thread	Hole	Width	Length

KFST32



Thread	Hole	Width	Length

KFST33

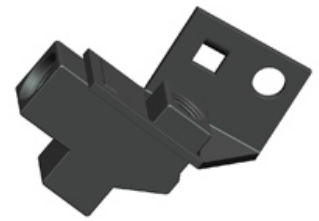

Thread	Hole	Width	Length

KFST34

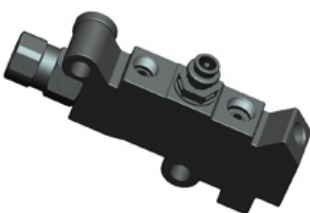

Thread	Hole	Width	Length

KFST35



Thread	Hole	Width	Length

KFST36



Thread	Hole	Width	Length



**KFST37**

Width	Hole	Length	Bend

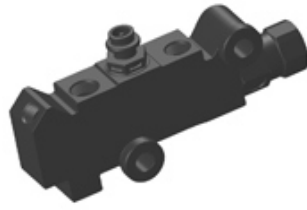
**KFST38**

Width	Hole	Length	Bend

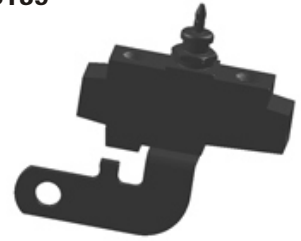
**KFST39**

Width	Hole	Length	Bend

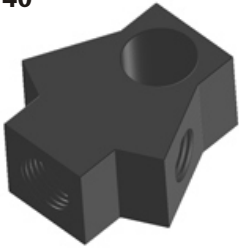
**KFST40**

Width	Hole	Length	Bend
32		34	2-3/8X24--7/16X20

**KFST41**

Width	Hole	Length	Bend
18		32	2-1/2X20-5/8X18

**KFST42**

Width	Hole	Length	Bend
37		43	2-3/8X24--7/16X20

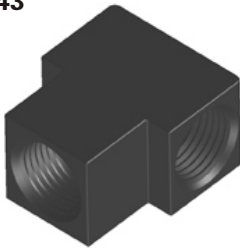
**KFST43**

Width	Hole	Length	Bend
22		25	2-3/8X24-7/16X20

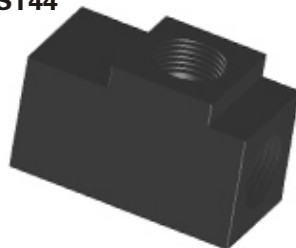
**KFST44**

Width	Hole	Length	Bend
24		38	2-1/2X20-5/8X18

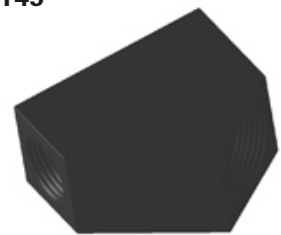
**KFST45**

Width	Hole	Length	Bend
18		38	2-1/2X20-5/8X18

**KFST46**

Width	Hole	Length	Bend
43		43	2-M10X1

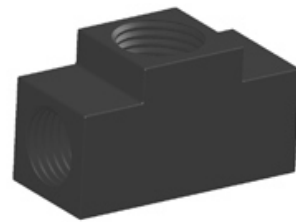
**KFST47**

Width	Hole	Length	Bend
13		28	2-3/8X24--1/8X27NPT

**KFST48**

Width	Hole	Length	Bend
28		59	3-M10X1

**KFST49**

Width	Hole	Length	Bend
7		47	

**KFST50**

Width	Hole	Length	Bend
14		30	2-1/8X27NPT--1/2X20

**KFST51**

Width	Hole	Length	Bend
25		45	3-3/8X24

**KFST52**

Width	Hole	Length	Bend

**KFST53**

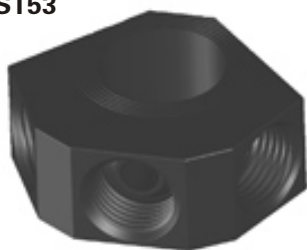

Width	Hole	Length	Bend
13		29	3-7/16X24

**KZF01**

Thread	Seat	Length	Bend
M10X1	H13		90°

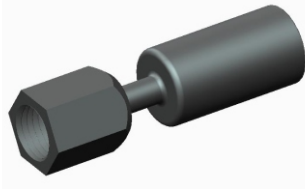
**KZF02**

Thread	Seat	Length	Bend
M10X1	H13	50	

**KZF03**

Thread	Seat	Length	Bend
3/8X24	H14	55	

**KZF04**

Thread	Seat	Length	Bend
M12X1	H19	55	

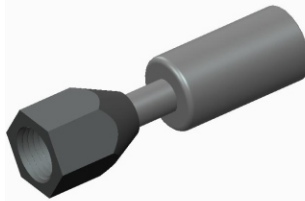
**KZF05**

Thread	Seat	Length	Bend
7/16X20	H14	44	

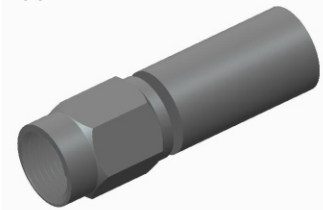
**KZF06**

Thread	Seat	Length	Bend
3/8X24	H11	37	

**KZF07**

Thread	Seat	Length	Bend
3/8X24	H12.7	36	

**KZF08**

Thread	Seat	Length	Bend
3/8X24	H12.6		

**KZF09**

Thread	Seat	Length	Bend
3/8X24	H12.6		

**KZF10**

Thread	Seat	Length	Bend
3/8X24	H13	51.6	

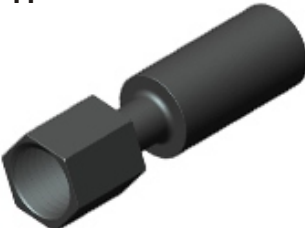
**KZF11**

Thread	Seat	Length	Bend
M12X1.5	H14		

**KZF12**

Thread	Seat	Length	Bend
	H17		

**KZF13**

Thread	Seat	Length	Bend
	24	41.2	

**KZF14**

Thread	Seat	Length	Bend
M12X1	H16	42.3	

**KZF15**

Thread	Seat	Length	Bend
3/8X24	H14		

**KZF16**



Thread	Seat	Length	Bend
3/8X24	H12.7	53.4	

**KZM01**

Thread	Seat	Length	Bend
7/16X24	H11	95	90°

**KZM01-2**

Thread	Seat	Length	Bend
7/16X24	H11	95	90°

**KZM02**

Thread	Seat	Length	Bend
3/8X24	H11	95	90°

**KZM02-2**

Thread	Seat	Length	Bend
M10X1	H11	95	90°

**KZM02-3**

Thread	Seat	Length	Bend
M10X1	H11	95	90°

**KZM03**

Thread	Seat	Length	Bend
M10X1	H11	76	

**KZM03B**

Thread	Seat	Length	Bend
M10X1	H11	76	

**KZM04**

Thread	Seat	Length	Bend
M10X1	H11	83	

**KZM04B**

Thread	Seat	Length	Bend
M10X1	H11	83	

**KZM04-2**

Thread	Seat	Length	Bend
M10X1	H11	85	

**KZM04-2B**

Thread	Seat	Length	Bend
M10X1	H11	85	

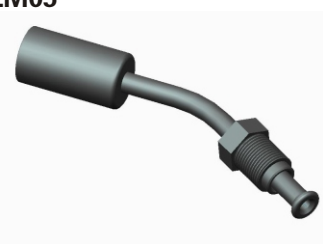
**KZM05**

Thread	Seat	Length	Bend
M10X1	H11	92	30°

**KZM05-2**

Thread	Seat	Length	Bend
M10X1	H11		130°

**KZM05-3**

Thread	Seat	Length	Bend
M10X1	H11		55°

**KZM06**

Thread	Seat	Length	Bend
M10X1	H11	92	20°

**KZM07**

Thread	Seat	Length	Bend
7/16X24	H11	102	45°

**KZM08**

Thread	Seat	Length	Bend
M10X1	H12	60	

**KZM08-2**

Thread	Seat	Length	Bend
M10X1	H11	60	

**KZM09**

Thread	Seat	Length	Bend
M10X1	H11	63	

**KZM09-2**

Thread	Seat	Length	Bend
M10X1	H12	63	

**KZM10**

Thread	Seat	Length	Bend
M10X1	H11	50	

**KZM10-2**

Thread	Seat	Length	Bend
M10X1	H10	50	

**KZM11**

Thread	Seat	Length	Bend
7/16X24	H11	62	

**KZM12**

Thread	Seat	Length	Bend
3/8X24	H11	58	

**KZM12-2**

Thread	Seat	Length	Bend
3/8X24	H10	58	

**KZM12-3**

Thread	Seat	Length	Bend
3/8X24	H11	58	

**KZM13**

Thread	Seat	Length	Bend
M10X1	H11	60	

**KZM13-2**

Thread	Seat	Length	Bend
M10X1	H10	60	

**KZM13-3**

Thread	Seat	Length	Bend
M10X1	H12	60	

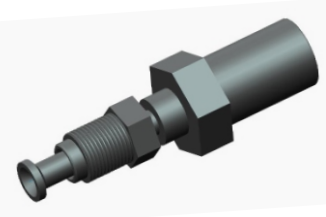
**KZM14**

Thread	Seat	Length	Bend
M10X1	H11	54	

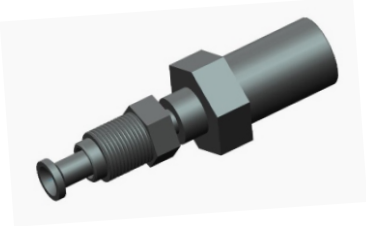
**KZM14-2**

Thread	Seat	Length	Bend
M10X1	H13	54	

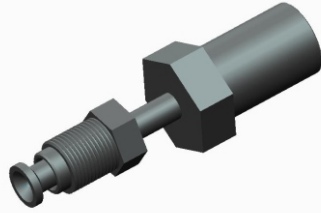
**KZM14-3**

Thread	Seat	Length	Bend
M10X1	H11	54	

**KZM15**

Thread	Seat	Length	Bend
7/16X24	H11	86	

**KZM16**

Thread	Seat	Length	Bend
M10X1	H11	62	

**KZM16-2**

Thread	Seat	Length	Bend
M10X1	H10	62	

**KZM17**

Thread	Seat	Length	Bend
M10X1	H11	58	

**KZM18**

Thread	Seat	Length	Bend
M10X1	H11	63	90°

**KZM18-2**

Thread	Seat	Length	Bend
M10X1	H10	63	90°

**KZM18-3**

Thread	Seat	Length	Bend
7/16X24	H11	63	90°

**KZM18-4**

Thread	Seat	Length	Bend
3/8X24	H10	63	90°

**KZM19**

Thread	Seat	Length	Bend
M10X1	H11	85	

**KZM20**

Thread	Seat	Length	Bend
7/16X24	H11	45	135°

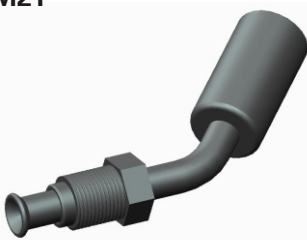
**KZM21**

Thread	Seat	Length	Bend
M10X1	H11	66	45°

**KZM21-2**

Thread	Seat	Length	Bend
3/8X24	H10	65	45°

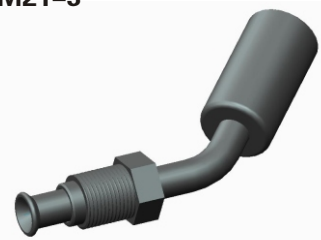
**KZM21-3**

Thread	Seat	Length	Bend
3/8X24	H10	69	45°

**KZM22**

Thread	Seat	Length	Bend
M10X1	H11	105	90°

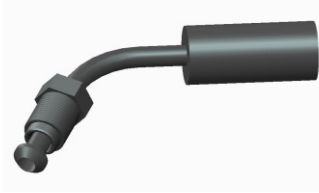
**KZM23**

Thread	Seat	Length	Bend
M10X1	H11	74	60°

**KZM24**

Thread	Seat	Length	Bend
M10X1	H15	140	20°

**KZM24B**

Thread	Seat	Length	Bend
M10X1	H15	140	20°

**KZM25**

Thread	Seat	Length	Bend
M10X1	H12	170	

**KZM25B**

Thread	Seat	Length	Bend
M10X1	H12	170	

**KZM26**

Thread	Seat	Length	Bend
M16X1.5	H17	173	

**KZM27**

Thread	Seat	Length	Bend
1/2X20	H13	60	

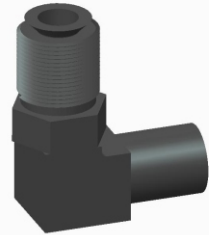
**KZM28**

Thread	Seat	Length	Bend
G1/4X19	H13	35	

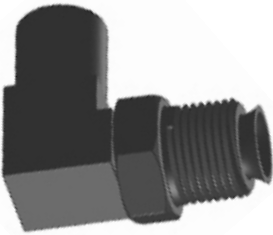
**KZM28-2**

Thread	Seat	Length	Bend
1/2X20	H13	35	

**KZM29**

Thread	Seat	Length	Bend
M16X1.5	17	88	135°

**KZM30**

Thread	Seat	Length	Bend
G1/4X19	H13	39	

**KZM30-2**

Thread	Seat	Length	Bend
1/2X20	H13	65	

**KZM31**

Thread	Seat	Length	Bend
G1/4X19	H13	37.5	

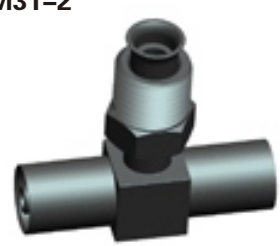
**KZM31-2**

Thread	Seat	Length	Bend
1/2X20	H13		



**KZM32**

Thread	Seat	Length	Bend
7/16X24	H11	120	

**KZM33**

Thread	Seat	Length	Bend
7/16X24	H11	260	30°

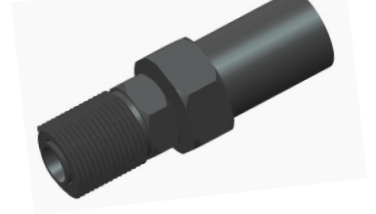
**KZM34**

Thread	Seat	Length	Bend
3/8X24	H14	40	

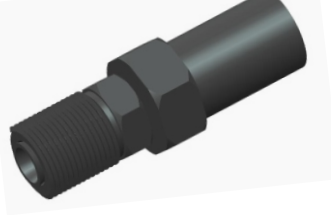
**KZM34-2**

Thread	Seat	Length	Bend
3/8X24	H11	40	

**KZM35**

Thread	Seat	Length	Bend
M10X1	H10	133	30°

**KZM36**

Thread	Seat	Length	Bend
M10X1	H12	150	

**KZM36B**

Thread	Seat	Length	Bend
M10X1	H12	150	

**KZM37**

Thread	Seat	Length	Bend
M10X1	H11	350	

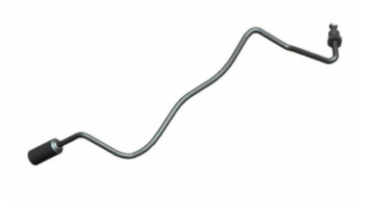
**KZM38**

Thread	Seat	Length	Bend
M10X1	H11	218	

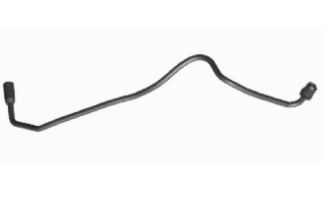
**KZM39**

Thread	Seat	Length	Bend
M10X1	H11	327	

**KZM40**

Thread	Seat	Length	Bend
3/8X24	H12	220	

**KZM41**

Thread	Seat	Length	Bend
3/8X24	H12	180	

**KZM42**

Thread	Seat	Length	Bend
M10X1	H11	263	

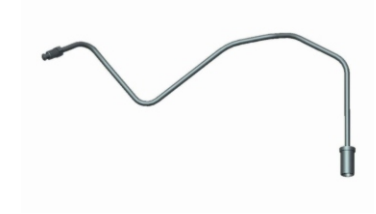
**KZM43**

Thread	Seat	Length	Bend
M10X1	H11	270	

**KZM44**

Thread	Seat	Length	Bend
M10X1	H11	130	

**KZM45**

Thread	Seat	Length	Bend
M10X1	H10	64	30°

**KZM46**

Thread	Seat	Length	Bend
3/8X24	H10	56.5	

**KZM47**

Thread	Seat	Length	Bend
M10X1	H11	67	

**KZM48**

Thread	Seat	Length	Bend
7/16X24	H11	31.5	

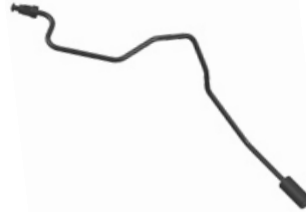
**KZM49**

Thread	Seat	Length	Bend
M10X1	H11		

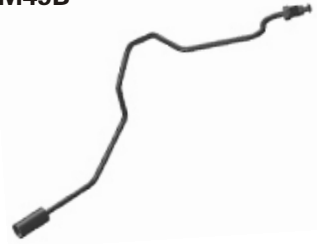
**KZM49B**

Thread	Seat	Length	Bend
M10 x 1	H11		

**KZM50**

Thread	Seat	Length	Bend
M10X1	H11		

**KZM50B**

Thread	Seat	Length	Bend
M10X1	H11		

**KZM51**

Thread	Seat	Length	Bend
1/2X20	H16	56.5	80°

**KZM52**

Thread	Seat	Length	Bend
3/8 x 24	H10		35°

**KZM53**

Thread	Seat	Length	Bend
3/8 x 24	H9.5		115°

**KZM54**

Thread	Seat	Length	Bend
M12X1	H13	55.3	

**KZM55**

Thread	Seat	Length	Bend
M12X1	H13	54.6	

**KZM56**

Thread	Seat	Length	Bend
M10 x 1	H11		30°

**KZM57**

Thread	Seat	Length	Bend
3/8 x 24	H9.5		90°

**KZM58**

Thread	Seat	Length	Bend
M10 x 1	H12.7	73.3	

**KZM59**

Thread	Seat	Length	Bend
7/16X24	H11	55	

**KZM60**

Thread	Seat	Length	Bend
M10 x 1	H14	74	

**KZM61**

Thread	Seat	Length	Bend
7/16x24	H11.13		90°

**KZM62**

Thread	Seat	Length	Bend
3/8x24	H9.53	76.2	

**KZM63**

Thread	Seat	Length	Bend
M12X1	H12		

**KZM64**

Thread	Seat	Length	Bend
1/2x20	H16	59.6	

**KZM65**

Thread	Seat	Length	Bend
1/2X20	H12.7	80	

**KZM66**

Thread	Seat	Length	Bend
3/8X24	H9.53		90°

**KZM67**

Thread	Seat	Length	Bend
7/16X24	H11.13	52	

**KZM68**

Thread	Seat	Length	Bend
7/16X24	H11.1		

**KZM69**

Thread	Seat	Length	Bend
M10x1	H11	64.2	

**MA001**

Thread	Seat	Length	Seal
M20X1.5	H21	50	

**MA001-2**

Thread	Seat	Length	Seal
M20X1.5	H22	50	

**MA001-3**

Thread	Seat	Length	Seal
M20X1.5	H21	50	

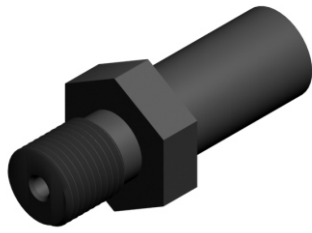
**MA002**

Thread	Seat	Length	Seal
1/2X20	H19	41	

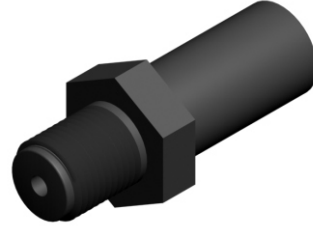
**MA002-2**

Thread	Seat	Length	Seal
1/2X20	H18	44	

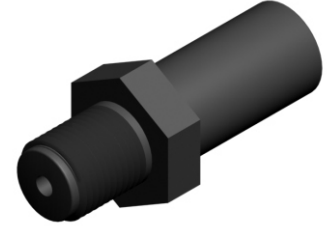
**MA002-3**

Thread	Seat	Length	Seal
1/2X20	H17	44	

**MA003**

Thread	Seat	Length	Seal
3/8X28		38	

**MA004**

Thread	Seat	Length	Seal
3/8X24	H17	53	

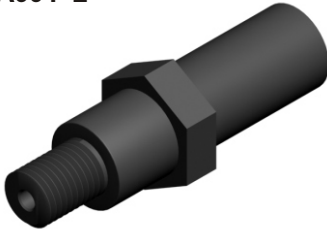
**MA004-2**

Thread	Seat	Length	Seal
3/8X24	H17	50	

**MA004-3**

Thread	Seat	Length	Seal
3/8X24	H17	55	

**MA004-4**

Thread	Seat	Length	Seal
3/8X24	H14	50	

**MA004-5**

Thread	Seat	Length	Seal
3/8X24	H14	42	

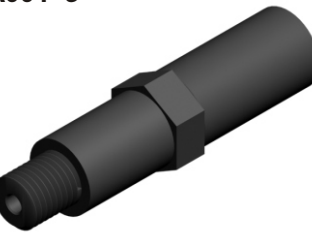
**MA004-6**

Thread	Seat	Length	Seal
3/8X24	H14	55	

**MA004-7**

Thread	Seat	Length	Seal
3/8X24	H14	46	

**MA004-8**

Thread	Seat	Length	Seal
3/8X24	H17	43	

MA004-9

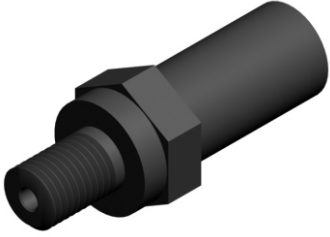

Thread	Seat	Length	Seal
3/8X24	H16	38	

MA005

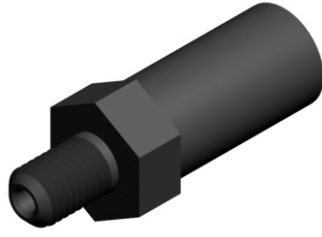

Thread	Seat	Length	Seal
3/8X24	H15	39	

MA005-2



Thread	Seat	Length	Seal
3/8X24	H15	36	

MA005-3



Thread	Seat	Length	Seal
3/8X24	H15	39	

MA005-4

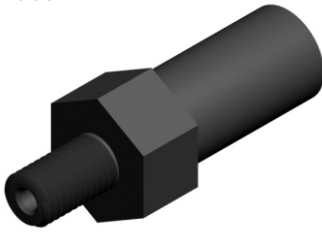

Thread	Seat	Length	Seal
3/8X24	H17	43	

MA005-5

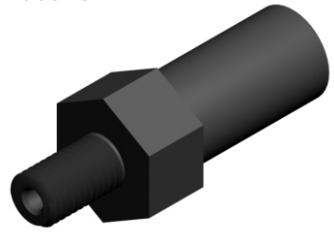

Thread	Seat	Length	Seal
3/8X24	H16	39	

MA006



Thread	Seat	Length	Seal
M10X1.25	H15	43	

MA006-2

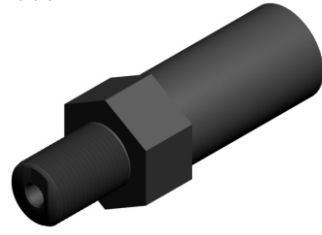

Thread	Seat	Length	Seal
M10X1.25	H15	45	

MA006-3



Thread	Seat	Length	Seal
M10X1.25	H15	42	

MA007

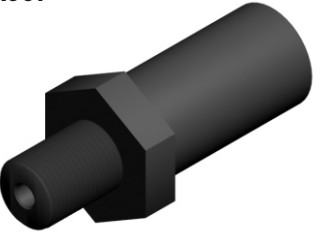

Thread	Seat	Length	Seal
M10X1	H17	40	

MA007-2

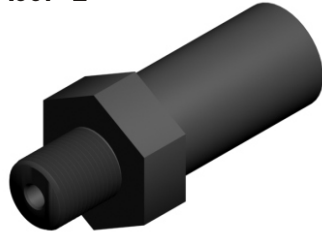

Thread	Seat	Length	Seal
M10X1	H17	36	

MA007-3

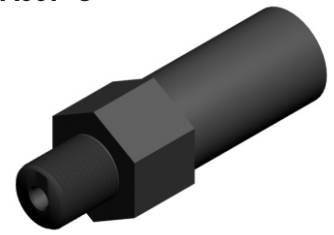

Thread	Seat	Length	Seal
M10X1	H15	41	

MA007-4



Thread	Seat	Length	Seal
M10X1	H17	36	

MA007-5



Thread	Seat	Length	Seal
M10X1	H17	37	

MA008

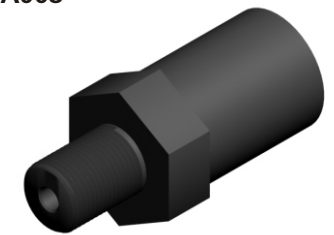

Thread	Seat	Length	Seal
M10X1.25	H17	40	

MA008-2

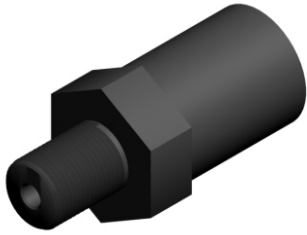

Thread	Seat	Length	Seal
M10X1.25	H17	36	

MA009

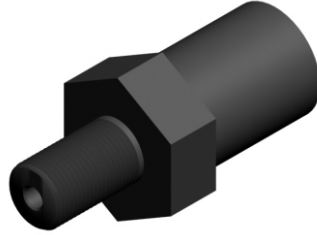

Thread	Seat	Length	Seal
M12X1.25	H19	43	

MA009-2



Thread	Seat	Length	Seal
M12X1.5	H17	43	

MA009-3

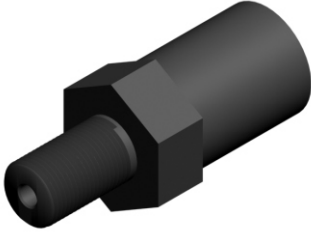

Thread	Seat	Length	Seal
M12X1.25	H19	44	

MA010



Thread	Seat	Length	Seal
M12X1	H19	40	

MA010-2



Thread	Seat	Length	Seal
M12X1	H17	40	

MA010-3



Thread	Seat	Length	Seal
M12X1.25	H19	40	

MA011



Thread	Seat	Length	Seal
M14X1	H16	51	

MA012



Thread	Seat	Length	Seal
1/2X20	H18	46	

MA013



Thread	Seat	Length	Seal
M12X1	H17	47	

MA014



Thread	Seat	Length	Seal
M10X1	H14	42	

MA014-2



Thread	Seat	Length	Seal
M10X1	H16	46	

MA015



Thread	Seat	Length	Seal
M10X1	H14	42	

MA015-2



Thread	Seat	Length	Seal
M10X1	H17	36	

MA015-3



Thread	Seat	Length	Seal
M10X1	H15	42	

**MA015-4**

Thread	Seat	Length	Seal
3/8X24	H16	42	

**MA015-5**

Thread	Seat	Length	Seal
M10 x 1	H17	44	

**MA016**

Thread	Seat	Length	Seal
M10X1	H17	48	

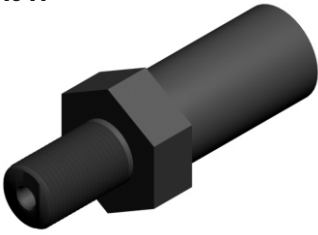
**MA017**

Thread	Seat	Length	Seal
M12X1.5	H17	46	

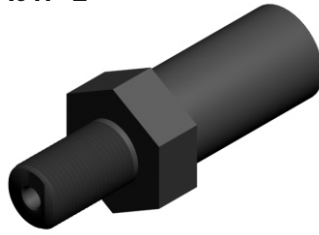
**MA017-2**

Thread	Seat	Length	Seal
M12X1.5	H19	40	

**MA018**

Thread	Seat	Length	Seal
7/16X20	H17	40	

**MA019**

Thread	Seat	Length	Seal
11/16X16	H19	50	

**MA019-2**

Thread	Seat	Length	Seal
M18X1.5	H19	50	

**MA020**

Thread	Seat	Length	Seal
7/16X20	H17	42	

**MA020-2**

Thread	Seat	Length	Seal
7/16X20	H15	40	

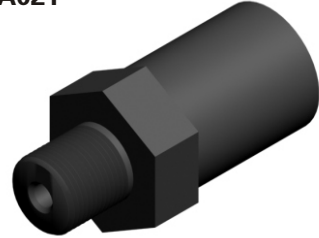
**MA021**

Thread	Seat	Length	Seal
M10X1	H17	42	

**MA022**

Thread	Seat	Length	Seal
M10X1	Φ21	46	

**MA022-2**

Thread	Seat	Length	Seal
M10X1	Φ19	47.5	

**MA023**

Thread	Seat	Length	Seal
M10X1	Φ21	43	

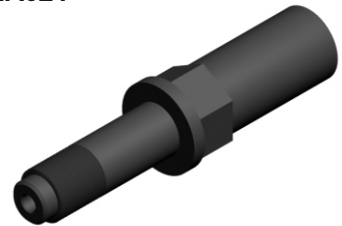
**MA024**

Thread	Seat	Length	Seal
M10X1	H14	62	

MA024-2

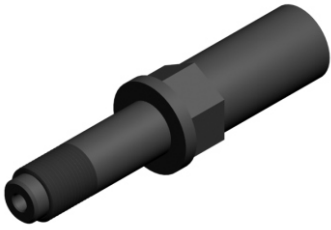

Thread	Seat	Length	Seal
M10X1	H14	62	

MA024-3

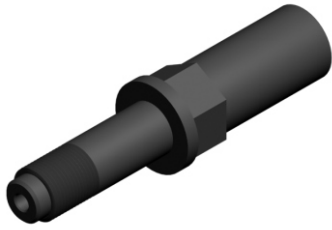

Thread	Seat	Length	Seal
M10X1	H14	62	

MA025

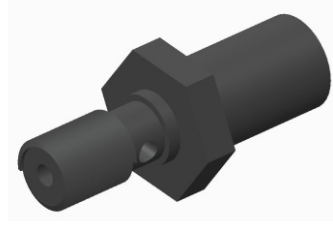

Thread	Seat	Length	Seal
M12X1	H19	50	

MA026

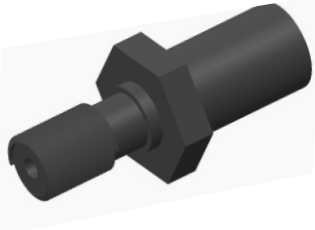

Thread	Seat	Length	Seal
M10X1	H17	50	

MA027

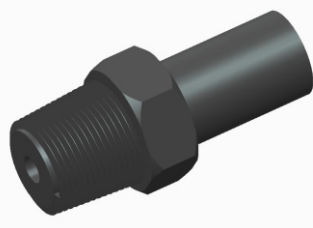

Thread	Seat	Length	Seal
M10X1	H17	50	

MA028

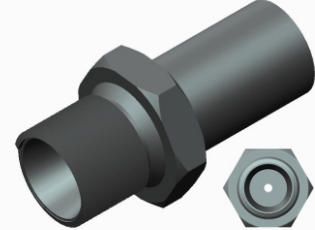

Thread	Seat	Length	Seal
M16X1.5	H19	37	

MA029



Thread	Seat	Length	Seal
M10 x 1	H16	41	

MA030



Thread	Seat	Length	Seal
M10 x 1	H16	43	

MA031



Thread	Seat	Length	Seal
3/8X20	H15	41	



**MB001**

Thread	Seat	Length	Seal
1/2X20	H17	55	

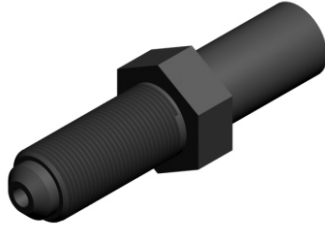
**MB001-2**

Thread	Seat	Length	Seal
1/2X20	H19	60	

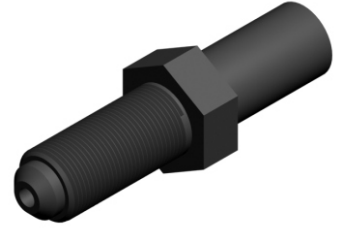
**MB001-3**

Thread	Seat	Length	Seal
1/2X20	H17	55	

**MB001-4**

Thread	Seat	Length	Seal
M14X1.5	H17	60.1	

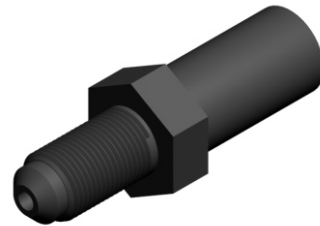
**MB002**

Thread	Seat	Length	Seal
7/16X20	H17	50	

**MB003**

Thread	Seat	Length	Seal
1/2X20	H17	60	

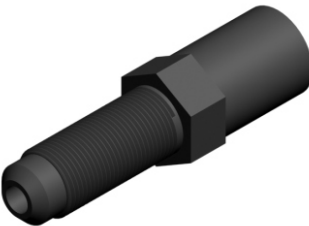
**MB003-2**

Thread	Seat	Length	Seal
7/16X20	H17	60	

**MB004**

Thread	Seat	Length	Seal
M14X1.5	H18	62	

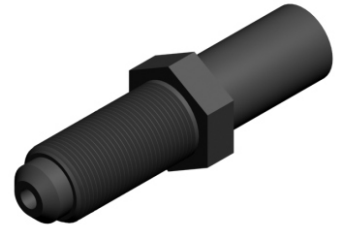
**MB004-2**

Thread	Seat	Length	Seal
7/16X20	H18	62	

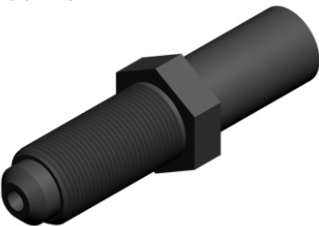
**MB004-3**

Thread	Seat	Length	Seal
M14X1.5	H18	52.5	

**MB004-4**

Thread	Seat	Length	Seal
M14X1.5	H17	64.26	

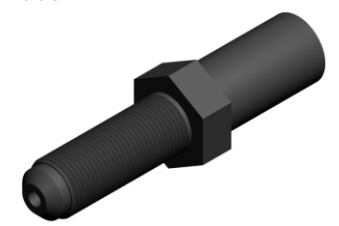
**MB005**

Thread	Seat	Length	Seal
M12X1.5	H17	61	

**MB006**

Thread	Seat	Length	Seal
M12X1.5	H17	60	

**MB006-2**

Thread	Seat	Length	Seal
M12X1.5	H17	60	

**MB007**

Thread	Seat	Length	Seal
M12X1	H17	60	

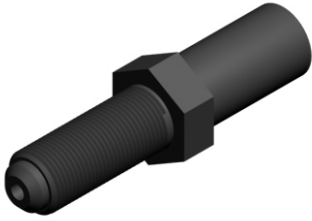
**MB007-2**

Thread	Seat	Length	Seal
M12X1	H19	60	

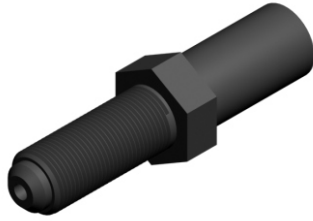
**MB007-3**

Thread	Seat	Length	Seal
M12X1	H17	60	

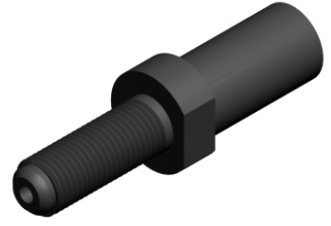
**MB008**

Thread	Seat	Length	Seal
M10X1	Φ18	55	

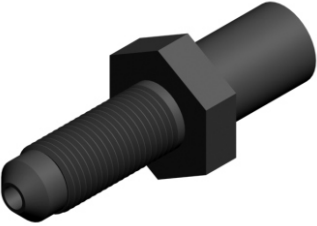
**MB009**

Thread	Seat	Length	Seal
M10X1	H15	49	

**MB009-2**

Thread	Seat	Length	Seal
M10X1	H15	52	

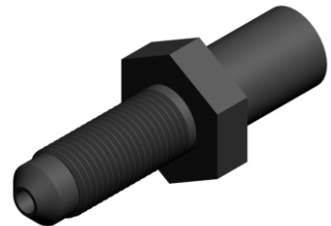
**MB009-3**

Thread	Seat	Length	Seal
M10X1	H14	49	

**MB009-4**

Thread	Seat	Length	Seal
3/8X24	H15	53	

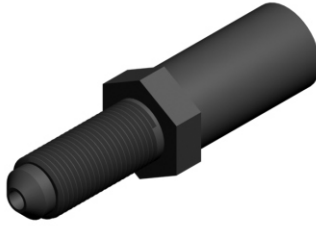
**MB010**

Thread	Seat	Length	Seal
3/8X24	H15	49	

**MB010-2**

Thread	Seat	Length	Seal
3/8X24	H15	51	

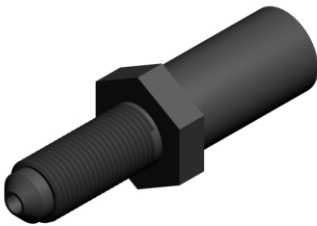
**MB011**

Thread	Seat	Length	Seal
3/8X24	H17	50	

**MB012**

Thread	Seat	Length	Seal
M10X1		52	

**MB013**

Thread	Seat	Length	Seal
M10X1	H17	48	

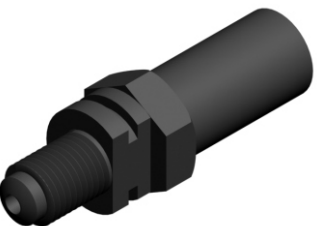
**MB013-2**

Thread	Seat	Length	Seal
M10X1	H14	48	

**MB013-3**

Thread	Seat	Length	Seal
M10X1	H14	48	

**MB013-4**

Thread	Seat	Length	Seal
M10X1	H17	50.56	

**MB014**

Thread	Seat	Length	Seal
3/8X24	H14	50	

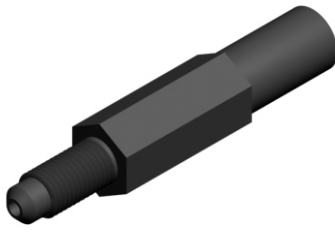
**MB015**

Thread	Seat	Length	Seal
M10X1.25	H15	75	

**MB015-2**

Thread	Seat	Length	Seal
M10X1	H15	79	

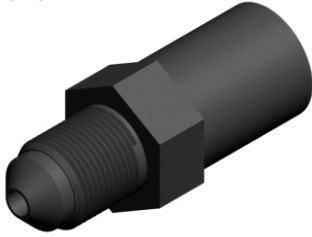
**MB016**

Thread	Seat	Length	Seal
1/2X20	H17	47	

**MB016-2**

Thread	Seat	Length	Seal
M10X1	H17	39	

**MB016-3**

Thread	Seat	Length	Seal
1/2X20	H14	47	

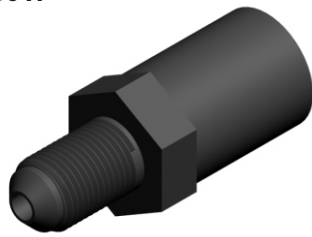
**MB017**

Thread	Seat	Length	Seal
M10X1.25	H16	44	

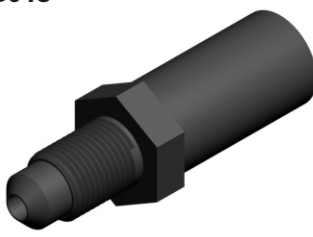
**MB018**

Thread	Seat	Length	Seal
M10X1.25	H15	42	

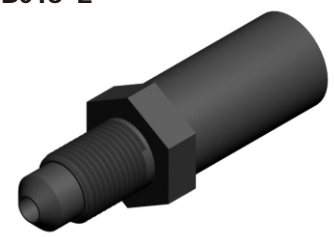
**MB018-2**

Thread	Seat	Length	Seal
3/8X24	H15	42	

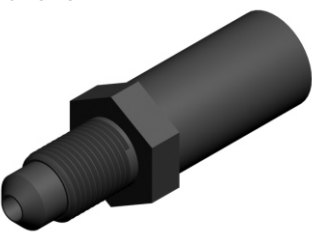
**MB018-3**

Thread	Seat	Length	Seal
M10X1.25	H14	42	

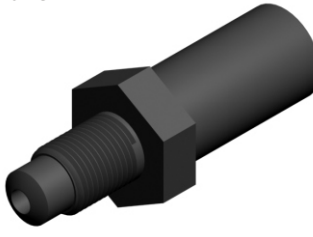
**MB019**

Thread	Seat	Length	Seal
M10X1	H15	43	

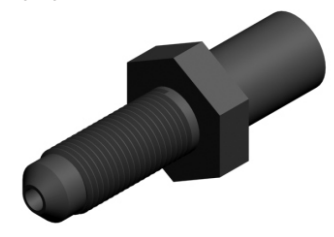
**MB020**

Thread	Seat	Length	Seal
3/8X24	H16	44	

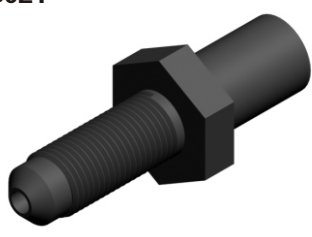
**MB021**

Thread	Seat	Length	Seal
7/16X20	H17	60	

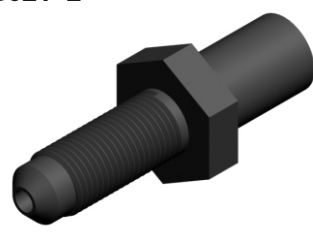
**MB021-2**

Thread	Seat	Length	Seal
M10X1	H17	60.5	

**MB021-3**

Thread	Seat	Length	Seal
7/16X20	H18	57.5	

**MB022**

Thread	Seat	Length	Seal
M12X1.5	H17	60	

**MB023**

Thread	Seat	Length	Seal
M12X1	H17	52	

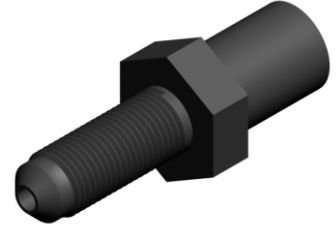
**MB024**

Thread	Seat	Length	Seal
3/8X24	H16	50	

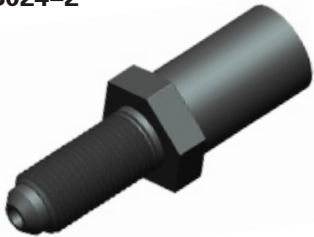
**MB024-2**

Thread	Seat	Length	Seal
M10X1	H16	49.2	

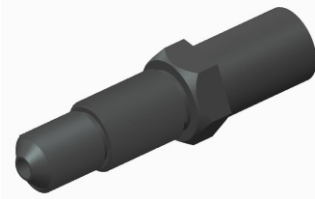
**MB025**

Thread	Seat	Length	Seal
3/8X24-1/2X20	H17	61.5	

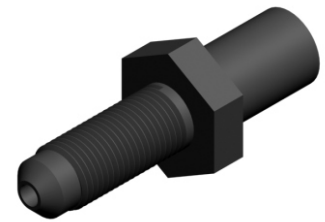
**MB026**

Thread	Seat	Length	Seal
3/8X24	H14	48	

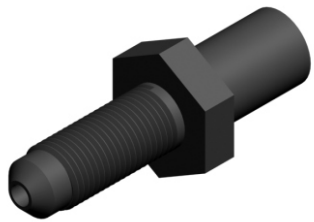
**MB026-2**

Thread	Seat	Length	Seal
3/8X24	H14	52	

**MB027**

Thread	Seat	Length	Seal
M12X1	H17	46	

**MB028**

Thread	Seat	Length	Seal
M12X1	H17	41	

**MB029**

Thread	Seat	Length	Seal
M12X1	H17	53.2	

**MC001**

Length	Seat	Thread
46	H22	M20X1.5--M14X1.5

**MC002**

Length	Seat	Thread
47	H19	M12X1--M16X1.5

**MC002-2(φ4.8Xφ12.5)**

Length	Seat	Thread
44	H19	M20X1.5--M14X1.5

**MC003**

Length	Seat	Thread
47	H21	M18X1.5--M12X1.5

**MC003-2**

Length	Seat	Thread
42	H19	M18X1.5--M12X1.5

**MC004**

Length	Seat	Thread
44	H17	M16X1.5--M10X1.25

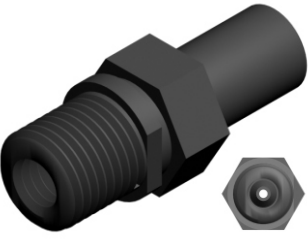
**MC005**

Length	Seat	Thread
48	H19	5/8X18--3/8X24

**MC005-2**

Length	Seat	Thread
51	H19	5/8X18--3/8X24

**MC006**

Length	Seat	Thread
53	H19	5/8X18--7/16X24

**MC007**

Length	Seat	Thread
40	H17	M14X1.5--M8X1.25

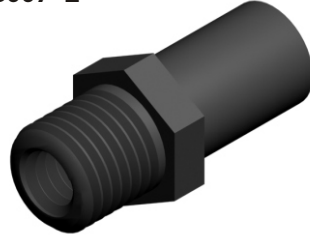
**MC007-2**

Length	Seat	Thread
40	H15	M14X1.5--M8X1.25

**MC008**

Length	Seat	Thread
44	H17	M16X1.5--M10X1

**MC009**

Length	Seat	Thread
51	H26	M22X1.5--M12X1.5

**MC010**

Length	Seat	Thread
42	H22	3/4X16--3/8X24

**MC010-2**

Length	Seat	Thread
42	H26	3/4X16--7/16X24

**MC011**

Length	Seat	Thread
47	H17	5/8X18--3/8X24

**MC012**

Length	Seat	Thread
43	H16	5/8X18--7/16X24

**MC013**

Length	Seat	Thread
44	H16	5/8X18--3/8X24

**MC014**

Length	Seat	Thread
40	H19	M16X1.5--M10X1.25

**MC015**

Length	Seat	Thread
45	H17	5/8X18--3/8X24

**MC015-2**

Length	Seat	Thread
45	H16	5/8X18--3/8X24

**MC015-3**

Length	Seat	Thread
46.5	H19	5/8X18--3/8X24

**MC016**

Length	Seat	Thread
45	H16	5/8X18--7/16X24

**MC017**

Length	Seat	Thread
47	H17	5/8X18--7/16X20

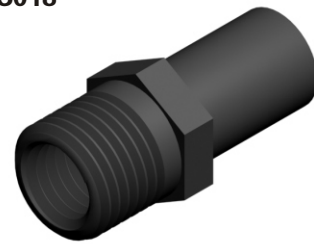
**MC018**

Length	Seat	Thread
43	H17	M18X1.5--M10X1.25

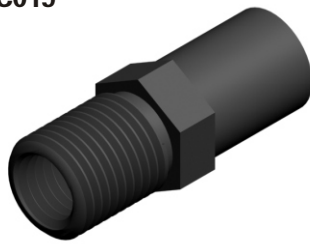
**MC019**

Length	Seat	Thread
47	H17	5/8X18--7/16X24

**MC020**

Length	Seat	Thread
37	H17	M16X1.5--M10X1.25

**MC020-2**

Length	Seat	Thread
37	H17	M16X1.5--3/8X24

**MC021**

Length	Seat	Thread
40	Φ18	M16X1.5--M8X1.25

**MC021-2**

Length	Seat	Thread
42	Φ19	M16X1.5--M8X1.25

**MC021-3**

Length	Seat	Thread
48	H19	M16X1.5--M8X1.25

**MC022**

Length	Seat	Thread
49	H18	5/8X26--7/16X20

**MC023**

Length	Seat	Thread
42	H18	5/8X26--3/8X20

**MC024**

Length	Seat	Thread
54	H18	5/8X26--3/8X24

**MC024-2**

Length	Seat	Thread
47	H17	5/8X26--3/8X24

**MC024-3**

Length	Seat	Thread
54	H19	5/8X26--3/8X24

**MC025**

Length	Seat	Thread
44	H19	M16X1.5--M10X1

**MC026**

Length	Seat	Thread
44	H19	M18X1.5--M12X1

**MC026-2**

Length	Seat	Thread
44	H19	M18X1.5--3/8X24

**MC027**

Length	Seat	Thread
42	H19	M16X1.5--M12X1.25

**MC028**

Length	Seat	Thread
47	H18	M16X1--3/8X24

**MC028-2**

Length	Seat	Thread
47	H16	M16X1.5--3/8X24

**MC029**

Length	Seat	Thread
45	H19	M18X1.5--M10X1.25

**MC029-2**

Length	Seat	Thread
45	H18	M18X1.5--M10X1.25

**MC030**

Length	Seat	Thread
45	H17	M16X1--3/8X24

MC030-2



Length	Seat	Thread
45	H18	M16X1--3/8X24

MC031



Length	Seat	Thread
46	H19	5/8X26--3/8X24

MC032



Length	Seat	Thread
45	H22	M20X1.5--M12X1

MC033



Length	Seat	Thread
46	H17.5	M10X1--5/8X18

MC033-2



Length	Seat	Thread
46	H17.5	3/8X24--5/8X18

MC034



Length	Seat	Thread
45	H17	7/16X24/5/8X18 □

MC035



Length	Seat	Thread
44	H16	3/8X24/5/8X18 □

MC036



Length	Seat	Thread
41	H17	M10X1--M16X1.5



**MD001**

Thread	Seat	Length	Seal
7/16X20	H16	112	

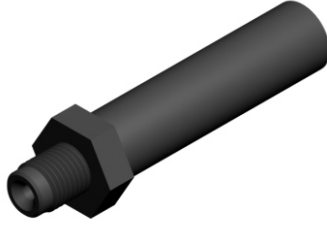
**MD002**

Thread	Seat	Length	Seal
M10X1	H17	70	

**MD003**

Thread	Seat	Length	Seal
7/16X20	H16	118	

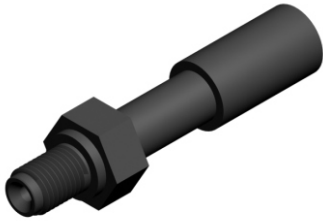
**MD003-2**

Thread	Seat	Length	Seal
3/8X24	H16	69	

**MD003-3**

Thread	Seat	Length	Seal
M12X1	H16	80	

**MD004**

Thread	Seat	Length	Seal
7/16X24	H16	83	

**MD004-2**

Thread	Seat	Length	Seal
3/8X24	H16	83	

**MD004-3**

Thread	Seat	Length	Seal
7/16X20	H16	69	

**MD004-4**

Thread	Seat	Length	Seal
3/8X24	H15	66	

**MD004-5**

Thread	Seat	Length	Seal
3/8X24	H16	74	

**MD004-6**

Thread	Seat	Length	Seal
7/16X20	H17	55	

**MD004-7**

Thread	Seat	Length	Seal
3/8X24	H16	69.2	

**MD004-8**

Thread	Seat	Length	Seal
7/16X20	H16	61.8	60°

**MD004-9**

Thread	Seat	Length	Seal
7/16X20	H16	83	

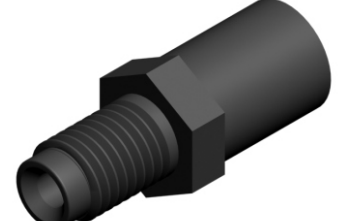
**MD005**

Thread	Seat	Length	Seal
M12X1.25	H17	45	

**MD006**

Thread	Seat	Length	Seal
M10X1	H16	41	

**MD006-2**

Thread	Seat	Length	Seal
7/16X20	H16	40	60°

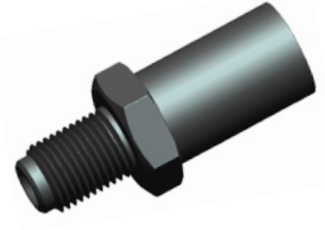
**MD006-3**

Thread	Seat	Length	Seal
M10X1	H16	40.2	

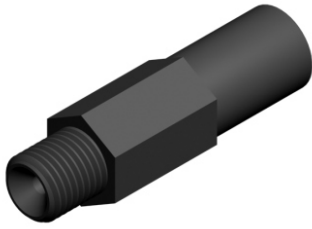
**MD007**

Thread	Seat	Length	Seal
7/16X20	H16	59	

**MD008**

Thread	Seat	Length	Seal
3/8X24	H15	58	

**MD008-2**

Thread	Seat	Length	Seal
3/8X24	H17	58	

**MD008-3**

Thread	Seat	Length	Seal
7/16X20	H16	67.6	

**MD008-4**

Thread	Seat	Length	Seal
7/16X20	H16	67.5	

**MD008-5**

Thread	Seat	Length	Seal
7/16X20	H16	87.2	

**MD009**

Thread	Seat	Length	Seal
M10X1	H14	43	

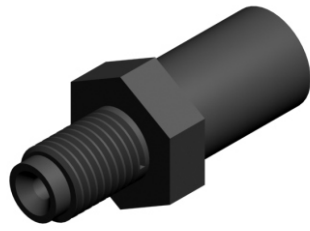
**MD010**

Thread	Seat	Length	Seal
M10X1	H14	43	

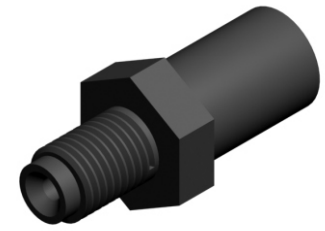
**MD010-2**

Thread	Seat	Length	Seal
7/16X24	H14	43	

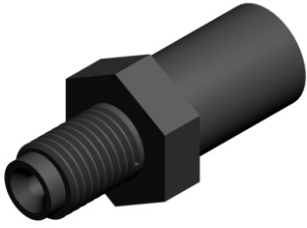
**MD010-3**

Thread	Seat	Length	Seal
M10X1	H14	40	

**MD010-4**

Thread	Seat	Length	Seal
M10X1	H14	44.4	

**MD010-5**

Thread	Seat	Length	Seal
M10X1	H14	43.5	

MD010-6



Thread	Seat	Length	Seal
M10X1	H14	40.5	60°

MD011



Thread	Seat	Length	Seal
3/8X24	H16	42	

MD011-2



Thread	Seat	Length	Seal
M12X1	H16	52	

MD011-3



Thread	Seat	Length	Seal
3/8X24	H14	42	

MD011-4



Thread	Seat	Length	Seal
3/8X24	H17	42	

MD011-5



Thread	Seat	Length	Seal
3/8X24	H14	38.3	

MD012



Thread	Seat	Length	Seal
3/8X24	H15	38	

MD012-2



Thread	Seat	Length	Seal
3/8X24	H16	41	

MD012-3



Thread	Seat	Length	Seal
3/8X24	H15	43	

MD012-4



Thread	Seat	Length	Seal
3/8X24	H15	39.5	84°

MD012-5



Thread	Seat	Length	Seal
3/8X24	H16	41	

MD013



Thread	Seat	Length	Seal
M12X1	H14	40	

MD013-2



Thread	Seat	Length	Seal
M12X1	H15	40	

MD013-3



Thread	Seat	Length	Seal
M10X1	H15	40.1	

MD014



Thread	Seat	Length	Seal
M12X1	H17	45	

**MD014-2**

Thread	Seat	Length	Seal
M10X1	H17	45	

**MD014-3**

Thread	Seat	Length	Seal
M12X1	H17	39	

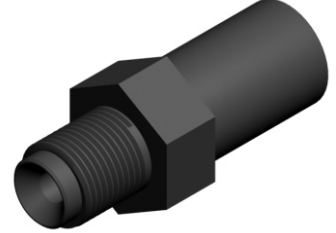
**MD015**

Thread	Seat	Length	Seal
7/16X20	H16	44	

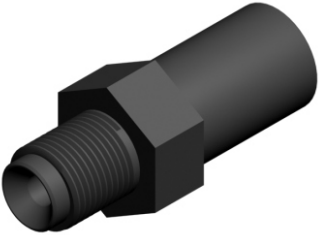
**MD015-2**

Thread	Seat	Length	Seal
7/16X20	H16	39	

**MD015-3**

Thread	Seat	Length	Seal
7/16X20	H14	42	

**MD015-4**

Thread	Seat	Length	Seal
7/16X20	H15	40	

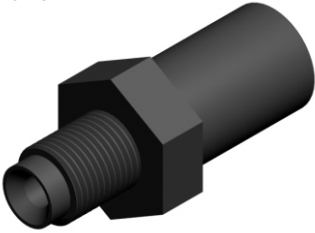
**MD016**

Thread	Seat	Length	Seal
M10X1.25	H17	37	

**MD016-2**

Thread	Seat	Length	Seal
M10X1.25	H14	39.7	90°

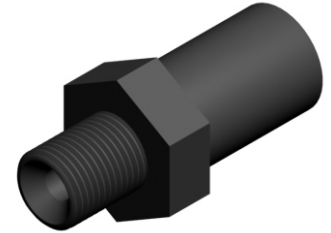
**MD017**

Thread	Seat	Length	Seal
M10X1	H17	38	

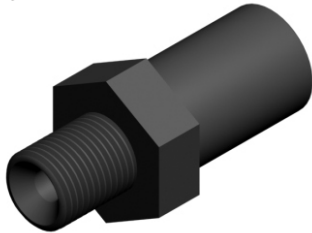
**MD017-2**

Thread	Seat	Length	Seal
M10X1	H17	42	

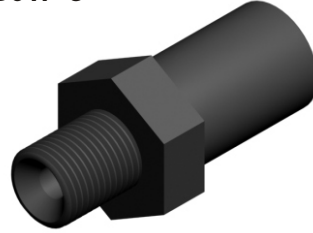
**MD017-3**

Thread	Seat	Length	Seal
M10X1	H17	38	

**MD017-4**

Thread	Seat	Length	Seal
M10X1	H16.8	39.2	74°

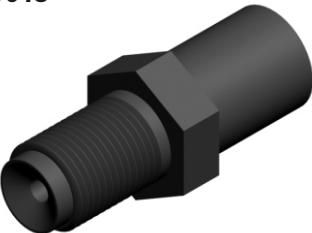
**MD018**

Thread	Seat	Length	Seal
M10X1.25	H17	39	

**MD018-2**

Thread	Seat	Length	Seal
M10X1.25	H16	39	

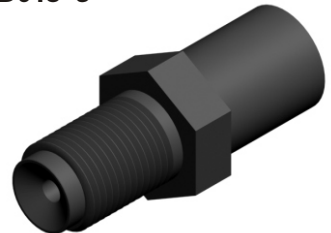
**MD018-3**

Thread	Seat	Length	Seal
M10X1.25	H14	39	

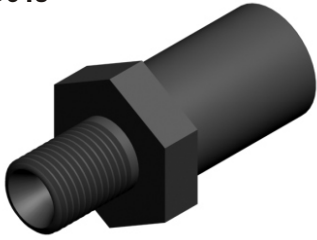
**MD019**

Thread	Seat	Length	Seal
3/8X24	H17	37	

**MD019-2**

Thread	Seat	Length	Seal
M10X1	H14	35	60°

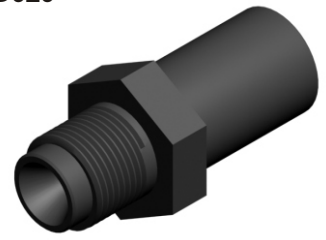
**MD020**

Thread	Seat	Length	Seal
M12X1.25	H17	38	

**MD021**

Thread	Seat	Length	Seal
M12X1.25	H17	48	

**MD021-2**

Thread	Seat	Length	Seal
M12X1	H16	61	

**MD022**

Thread	Seat	Length	Seal
7/16X20	H17	57	

**MD022-2**

Thread	Seat	Length	Seal
7/16X20	H16	57	

**MD022-3**

Thread	Seat	Length	Seal
7/16X24	H15.9	53.3	90°

**MD023**

Thread	Seat	Length	Seal
11/16X16	H19	50	

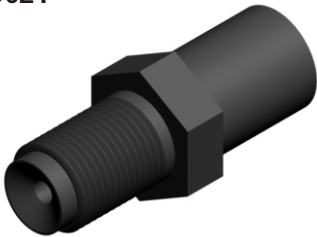
**MD024**

Thread	Seat	Length	Seal
M14X1.5	H19	50	

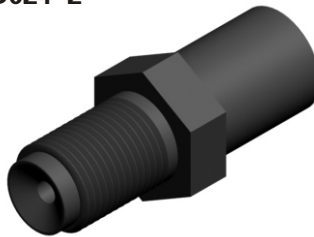
**MD024-2**

Thread	Seat	Length	Seal
M10X1.25	H19	50	

**MD024-3**

Thread	Seat	Length	Seal
M14X1.5	H17	50.55	60°

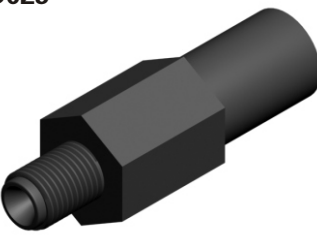
**MD025**

Thread	Seat	Length	Seal
3/8X24	H16	52	

**MD025-2**

Thread	Seat	Length	Seal
7/16X20	H16	54.8	

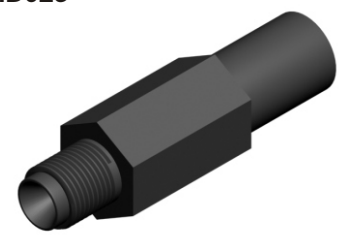
**MD026**

Thread	Seat	Length	Seal
7/16X20	H16	59	

**MD026-2**

Thread	Seat	Length	Seal
7/16X20	H16	60.5	

**MD027**

Thread	Seat	Length	Seal
7/16X24	H16	75	

**MD028**

Thread	Seat	Length	Seal
1/7X27NPTF	H12.7	28	

**MD029**

Thread	Seat	Length	Seal
3/8X24	H16	61.5	

**MD029-2**

Thread	Seat	Length	Seal
3/8X24	H16	60	

**MD029-3**

Thread	Seat	Length	Seal
M12X1	H16	60	

**MD030**

Thread	Seat	Length	Seal
1/8X27NPTF	H14	36.7	

**MD030-3**

Thread	Seat	Length	Seal
1/8X27NPTF	H14	39.1	

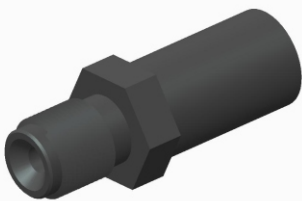
**MD031**

Thread	Seat	Length	Seal
7/16X24	H14	38.5	

**MD032**

Thread	Seat	Length	Seal
1/4X18	H19	38	

**MD033**

Thread	Seat	Length	Seal
M10X1	H17	37.8	

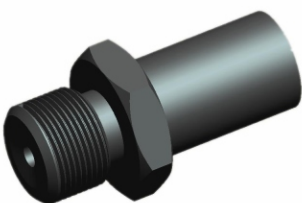
**MD034**

Thread	Seat	Length	Seal
M14X1.5	H19	38	

**MD035**

Thread	Seat	Length	Seal
7/16x20	H16	40.4	90°

**MD036**

Thread	Seat	Length	Seal
M10X1	H17	38	

**MD037**



Thread	Seat	Length	Seal
M12X1	H17	45.3	

**MD038**



Thread	Seat	Length	Seal
1/8X27	H14	38.5	60°

**MD039**



Thread	Seat	Length	Seal
M10X1	H14	46.16	

**MD040**

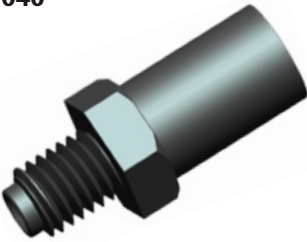

Thread	Seat	Length	Seal
M10X1.5	H16	39	